

# Physics of CMB Anisotropies

Eiichiro Komatsu

(Max-Planck-Institut für Astrophysik)

“Summary School on Cosmology 2018”, ICTP

June 18–21, 2018

# Lecture Slides

- Available at
  - <https://www.mpa.mpa-garching.mpg.de/~komatsu/lectures--reviews.html>
- Or, just find my website and follow “LECTURES & REVIEWS” link

# Planning: Day 1 (today)

- **Lecture 1 [9:15–10:30]**
  - Brief introduction of the CMB research
  - Temperature anisotropy from gravitational effects
  - Power spectrum basics

# Planning: Day 2

- **Lecture 2 [9:15–10:30]**
  - Temperature anisotropy from hydrodynamical effects (sound waves)



# Planning: Day 3

- **Lecture 3 [14:00–15:15]**
  - Cosmological parameter dependence of the temperature power spectrum
  - Polarisation of the CMB

# Planning: Day 4

- **Lecture 4 [11:15–12:30]**
  - Polarisation [continued]
  - Gravitational waves and their imprints on the CMB

The background of the slide is a Cosmic Microwave Background (CMB) radiation map, showing a mottled pattern of blue, white, and brownish-red colors representing temperature fluctuations across the universe.

**Hot, dense, opaque universe**

**-> “Decoupling” (transparent universe)**

**-> Structure Formation**

*From “Cosmic Voyage”*



# Sky in Optical ( $\sim 0.5\mu\text{m}$ )



courtesy University of Arizona

# Sky in Microwave ( $\sim 1\text{mm}$ )

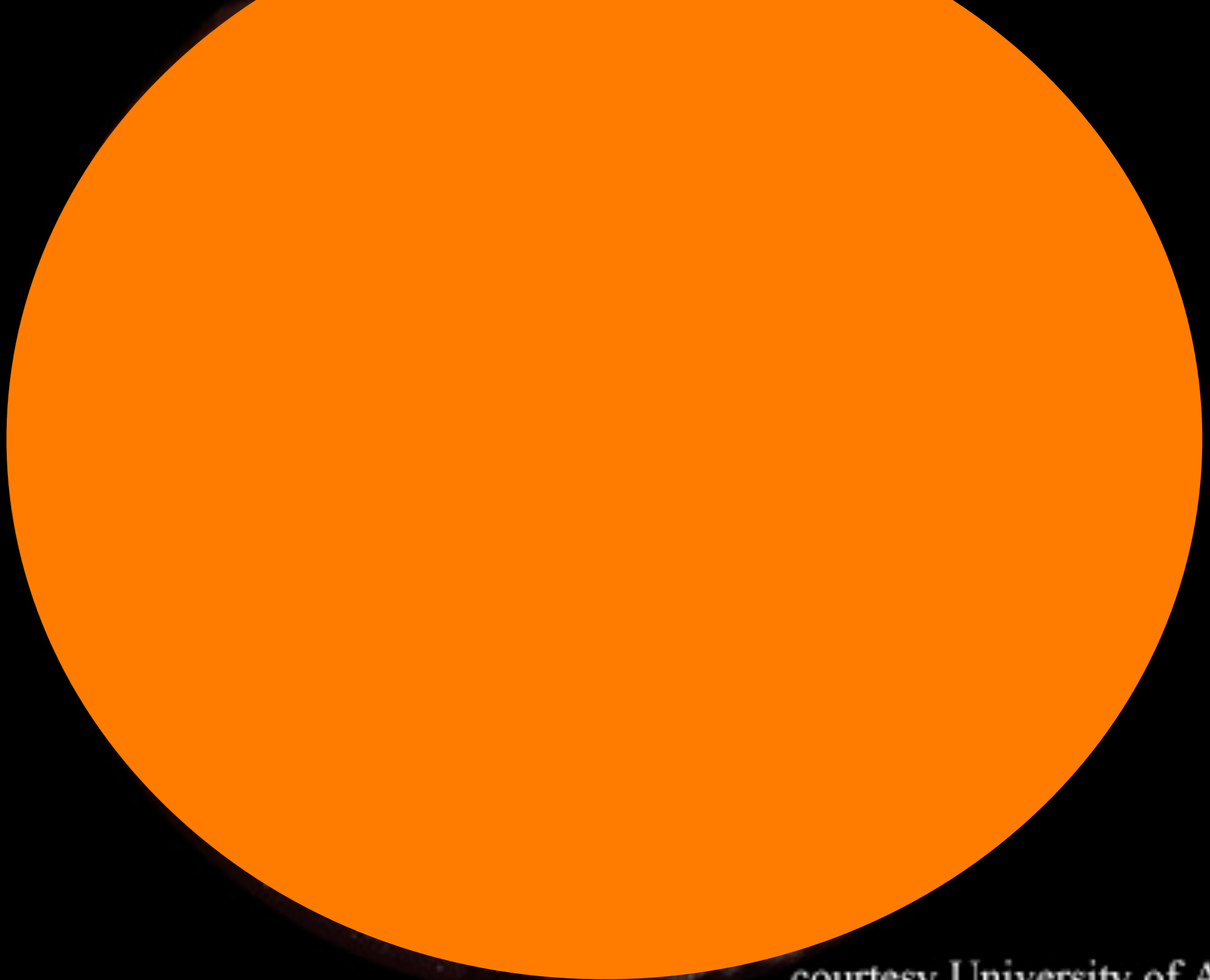

courtesy University of Arizona

# Sky in Microwave ( $\sim 1\text{mm}$ )

*Light from the fireball Universe  
filling our sky (2.7K)*

**The Cosmic Microwave  
Background (CMB)**

**410 photons**  
per  
cubic centimeter!!



A photograph of Prof. Hiranya Peiris, a woman with long dark hair, wearing a black cardigan over a black top with a colorful patterned collar. She is holding a vintage, light-colored television set with a handle. The TV screen displays a blue and white static pattern. The background is dark, and there is a wooden ledge or desk in front of her.

**Prof. Hiranya Peiris**  
**(Univ. College London)**

**All you need to do is to detect radio waves. For example, 1% of noise on the TV is from the fireball Universe**



1965

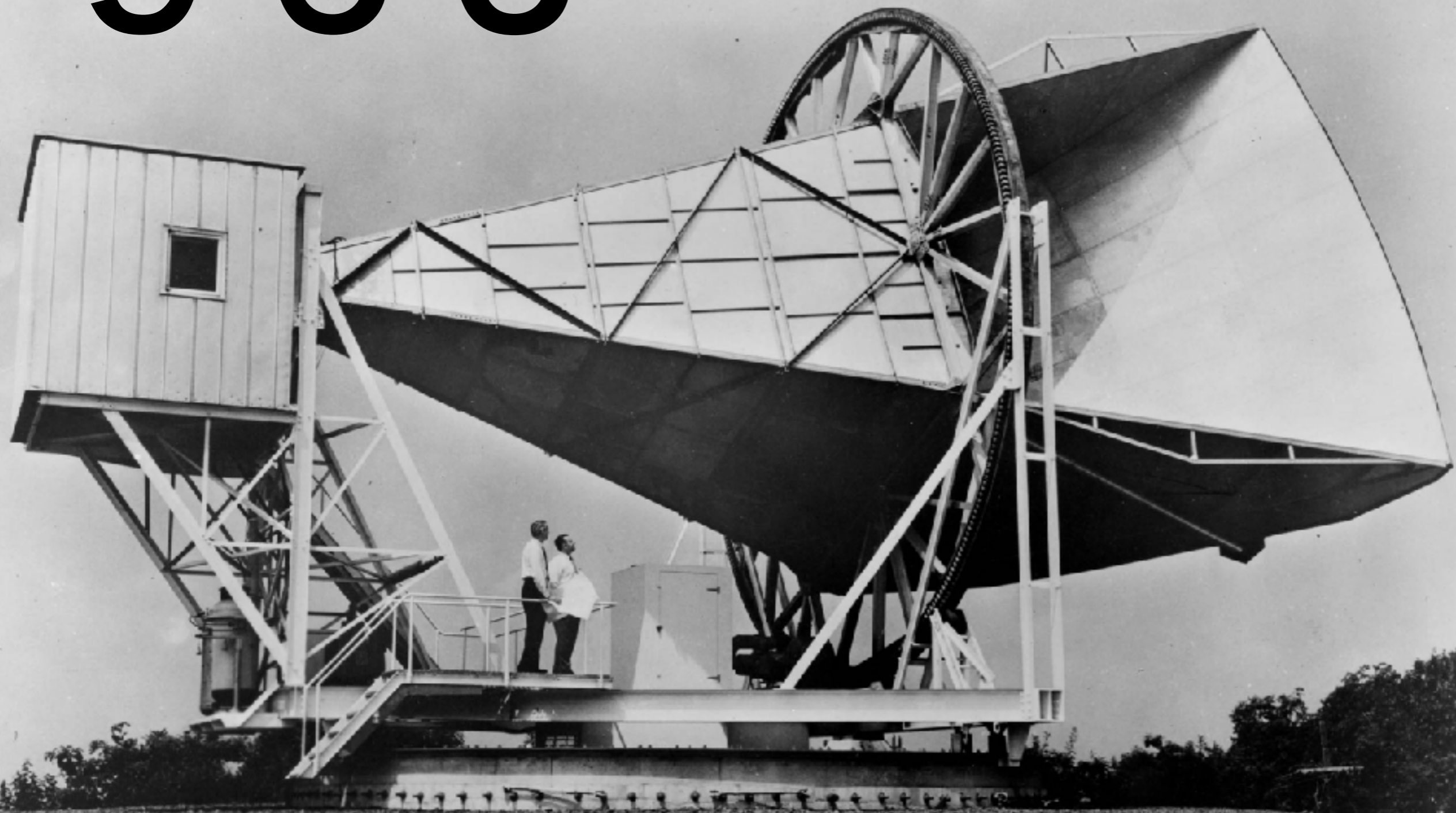



1:25 model of the antenna at Bell Lab  
The 3rd floor of Deutsches Museum





# The real detector system used by Penzias & Wilson The 3rd floor of Deutsches Museum



**Donated by Dr. Penzias,  
who was born in Munich**





Hornantennenanschluss

Horn antenna

Hohlleiterzug

R Rauschquelle

F Frequenzmischer und Verstärker

M MASER-Verstärker

V Vergleichsquelle

Calibrator, cooled to 5K by liquid helium

Amplifier

Recorder

Schreiber

many  
radio  
istic  
n be  
m  
y  
e

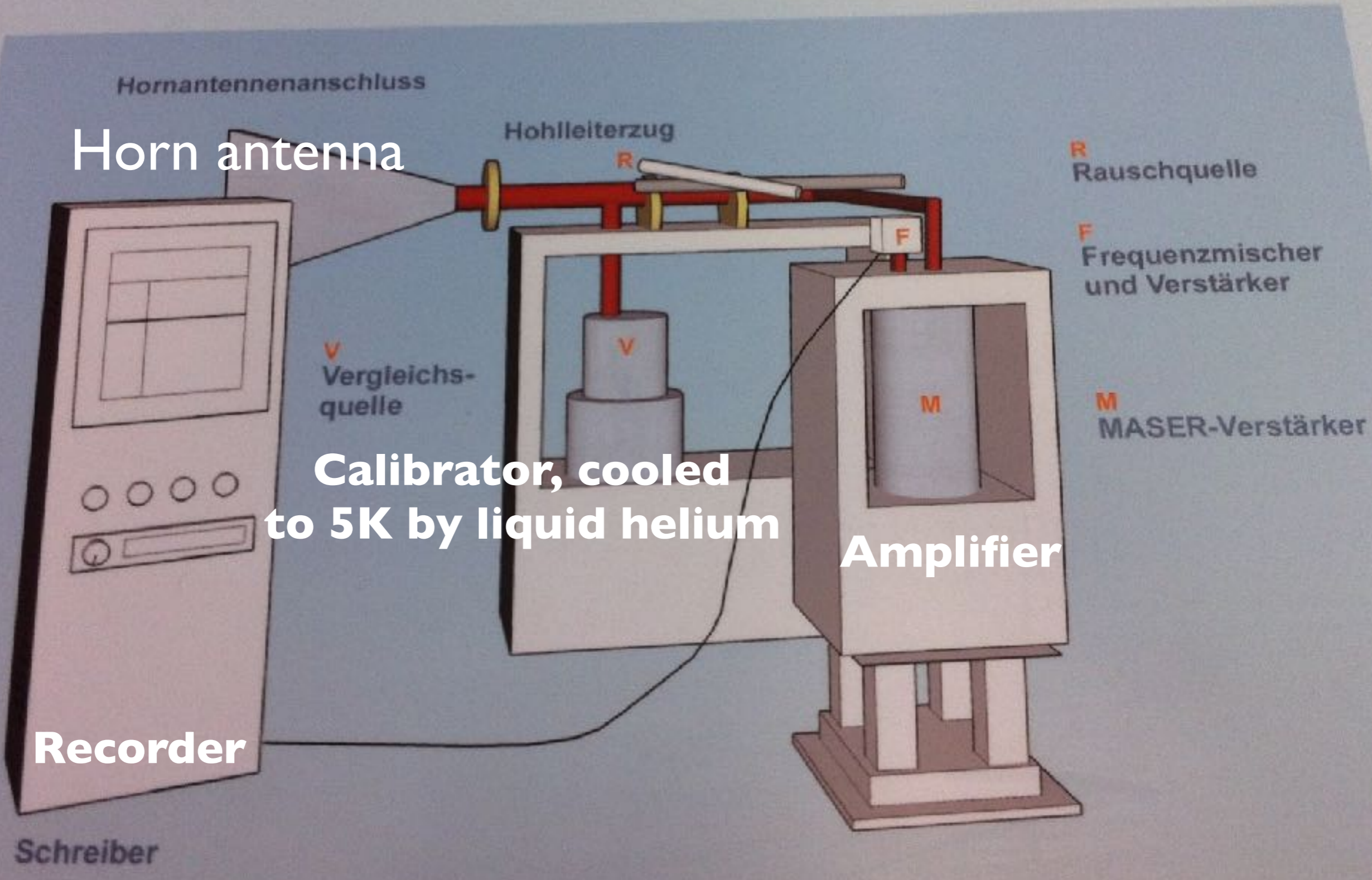





Brightness

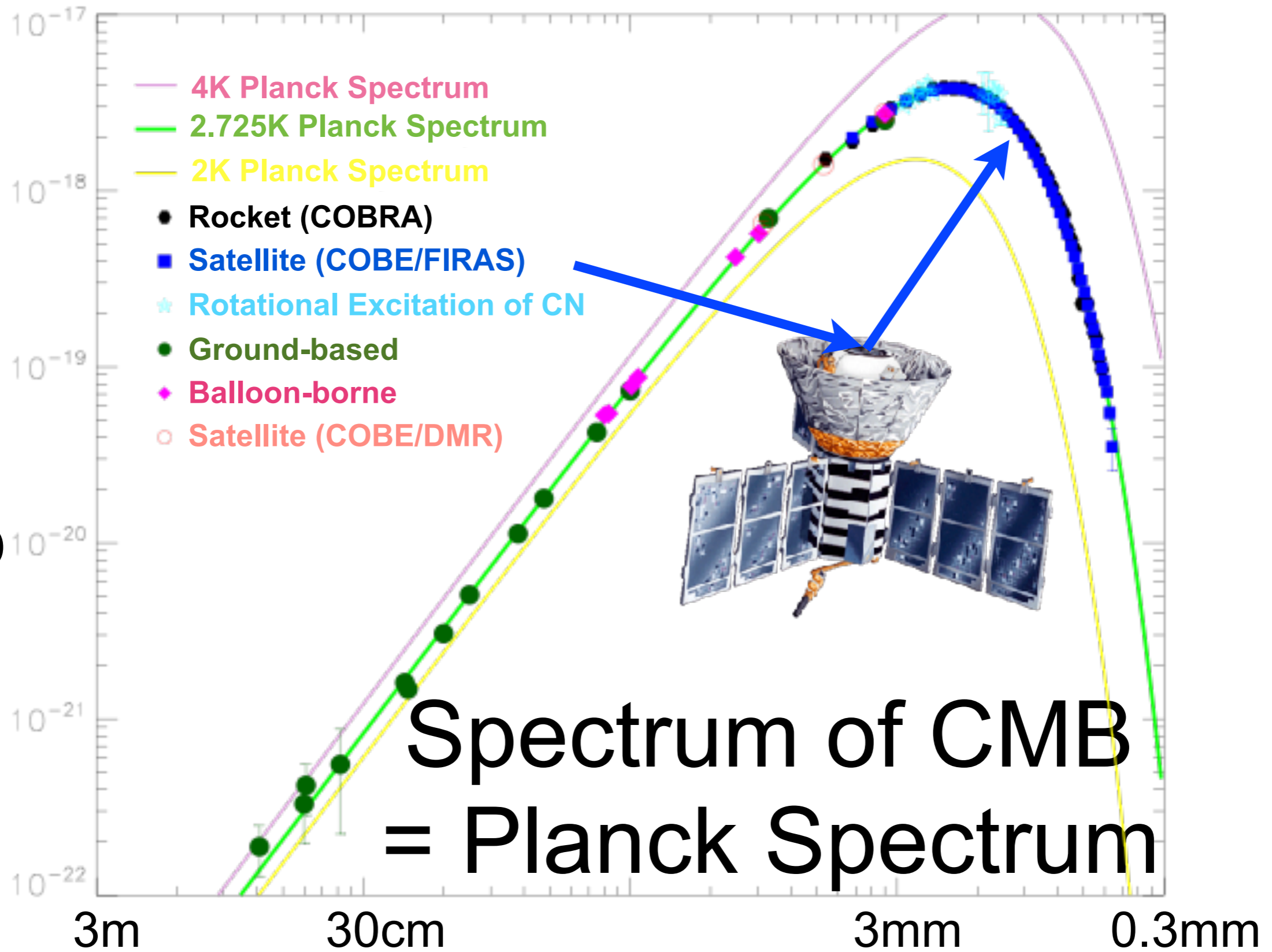





**Full-dome movie for planetarium**  
**Director: Hiromitsu Kohsaka**

# HORIZON

Beyond the Edge of the Visible Universe

**Won the Best Movie Awards at  
“FullDome Festival” at Brno, June 5–8, 2018**

▶ ⏩ 🔊 2:27 / 2:51



**1989 COBE**

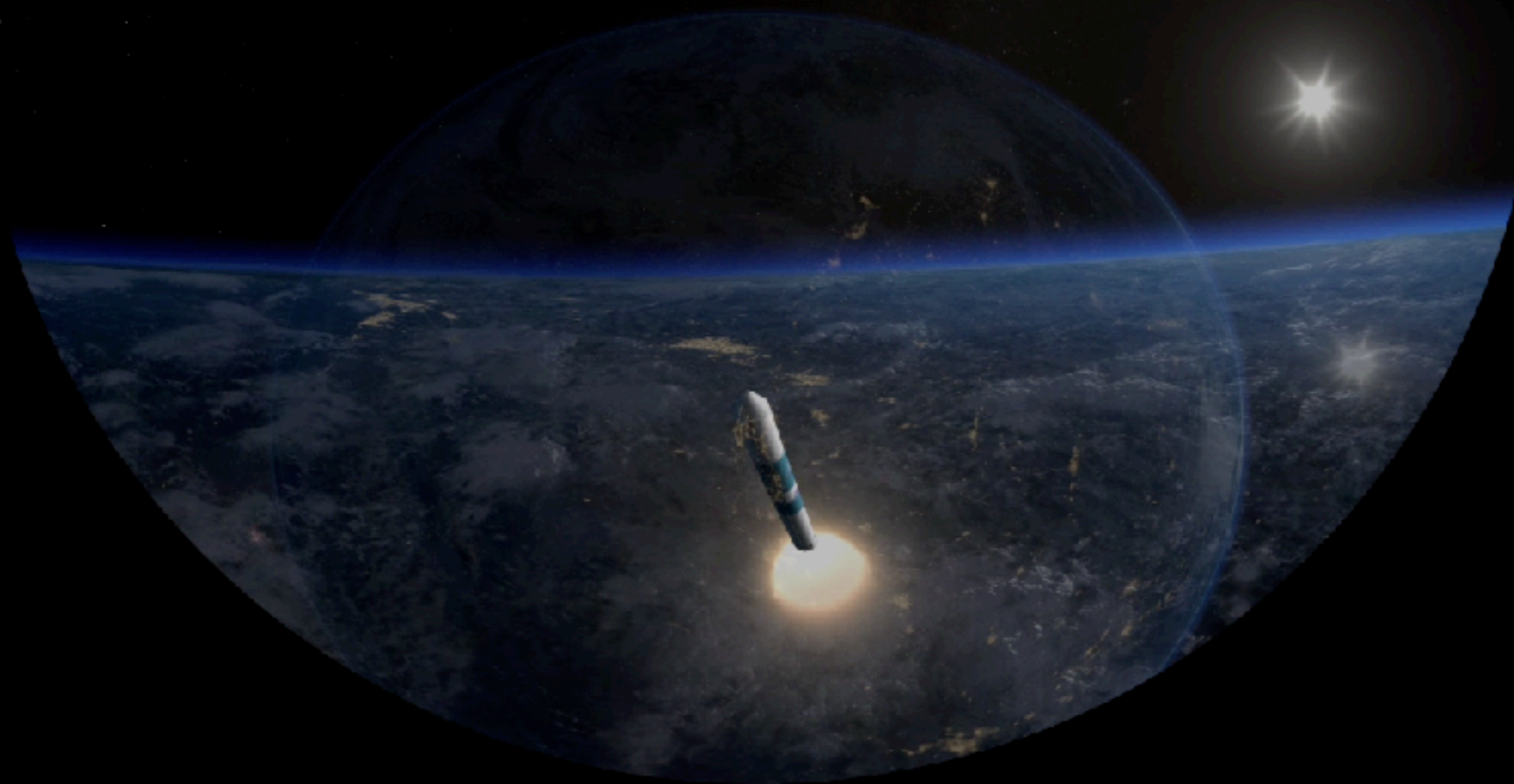



# 2001 WMAP



Princeton University (USA) 



# WMAP Science Team

## July 19, 2002



- WMAP was launched on June 30, 2001
- The WMAP mission ended after 9 years of operation



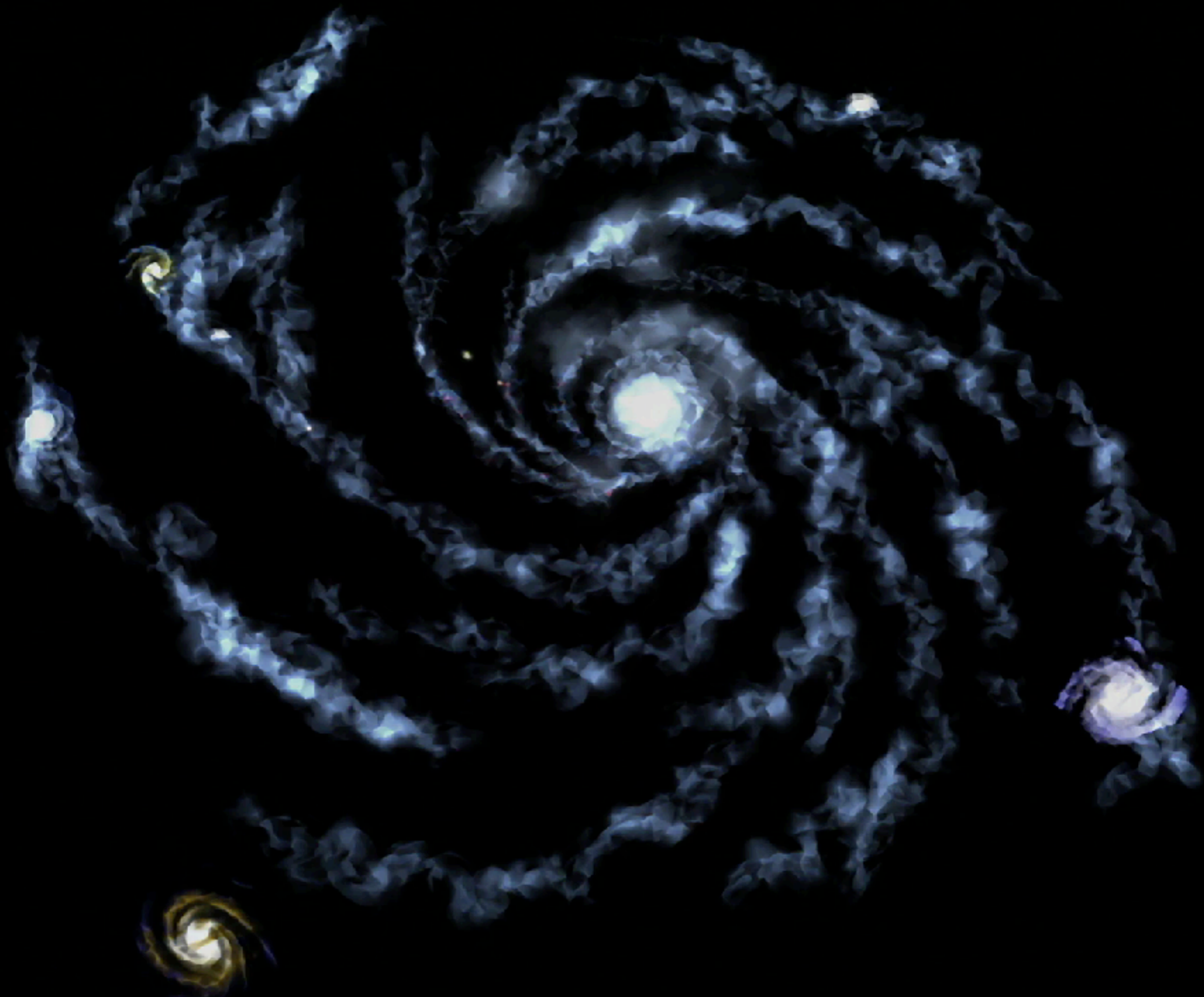

# Concept of “Last Scattering Surface”

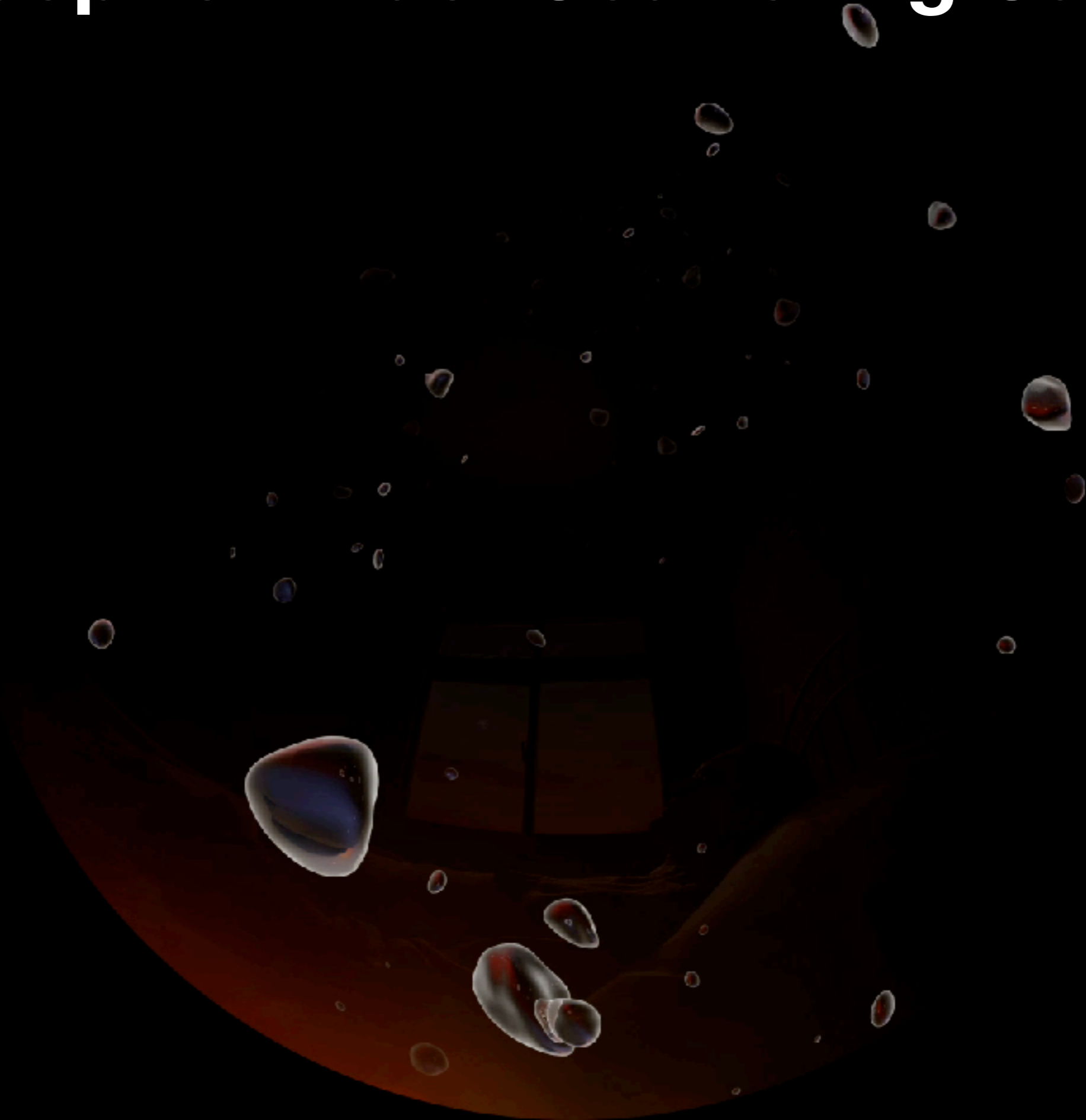



# Today: Light Propagation in a Clumpy Universe

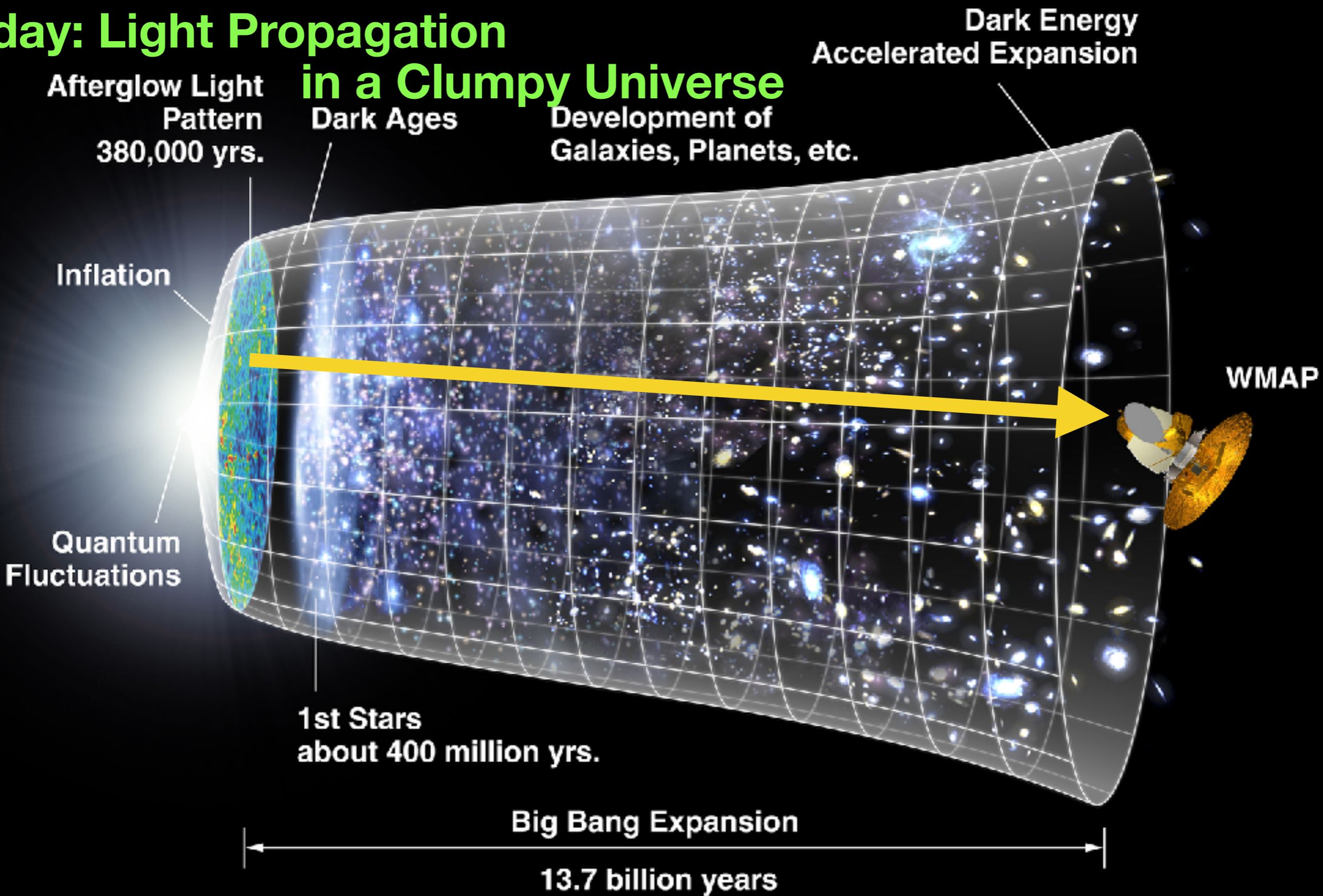



# Tomorrow: Hydrodynamics at LSS

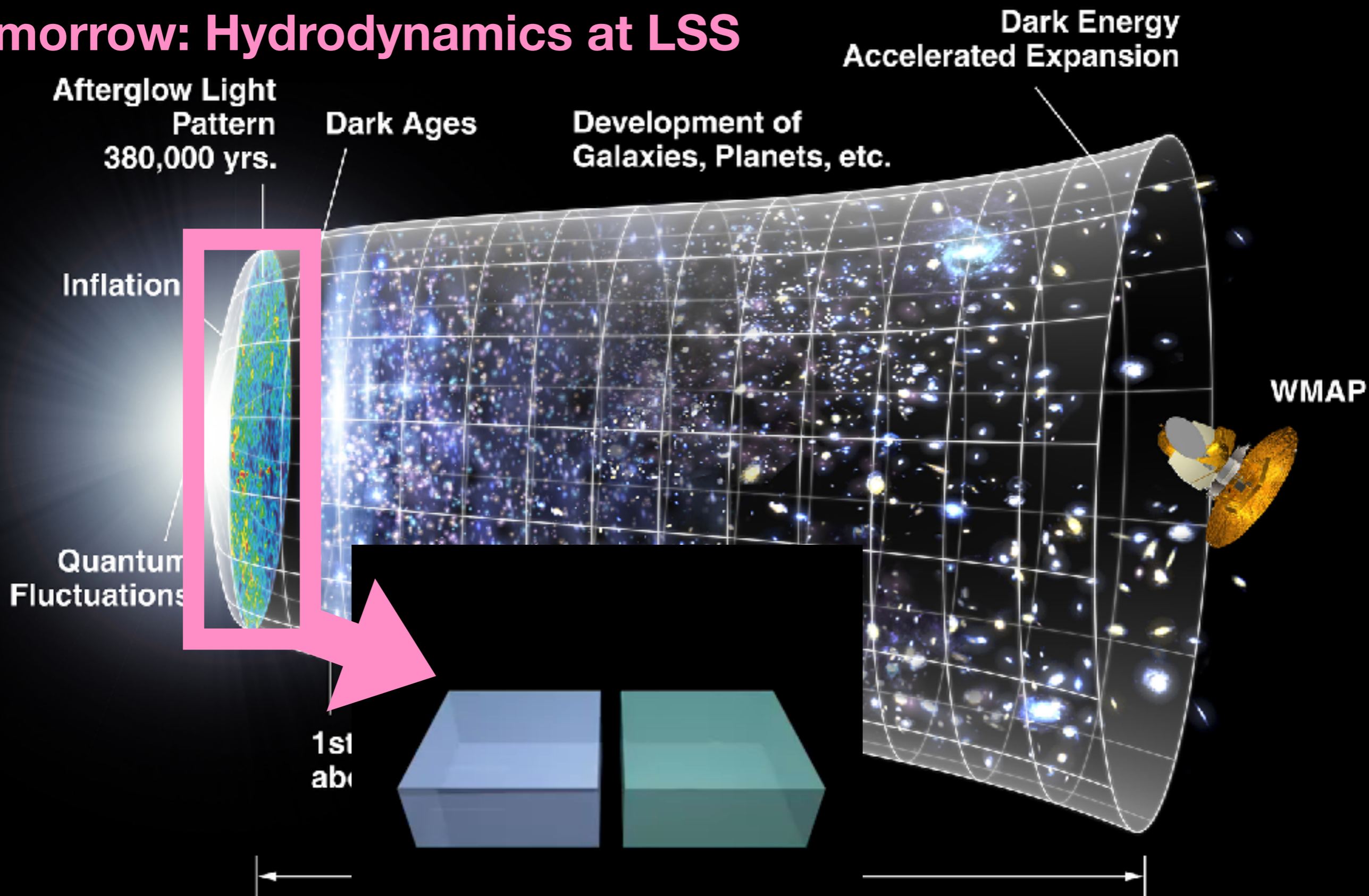



# Topics not covered by this lecture

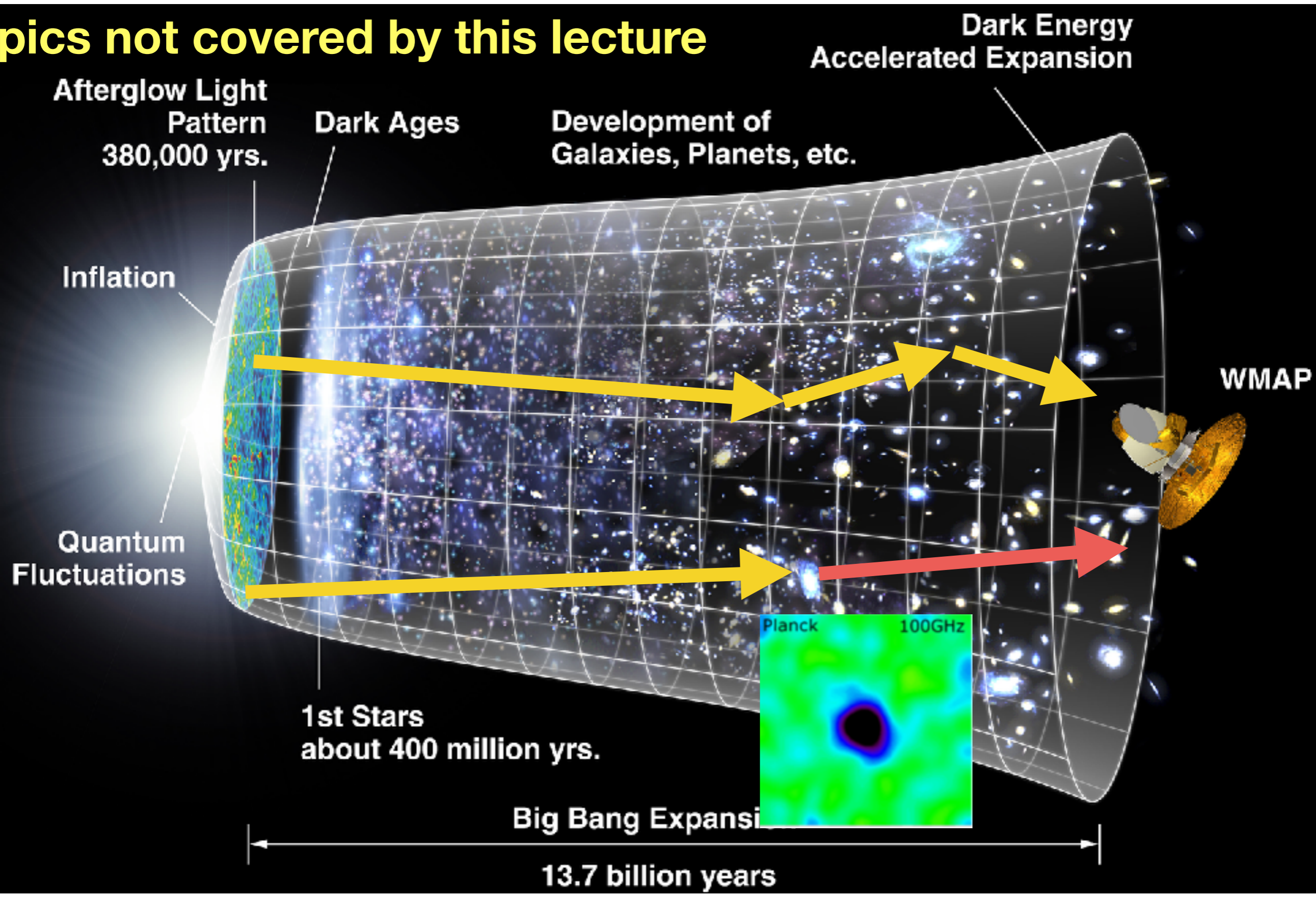

# Notation

- Notation in my lectures follows that of the text book “Cosmology” by Steven Weinberg

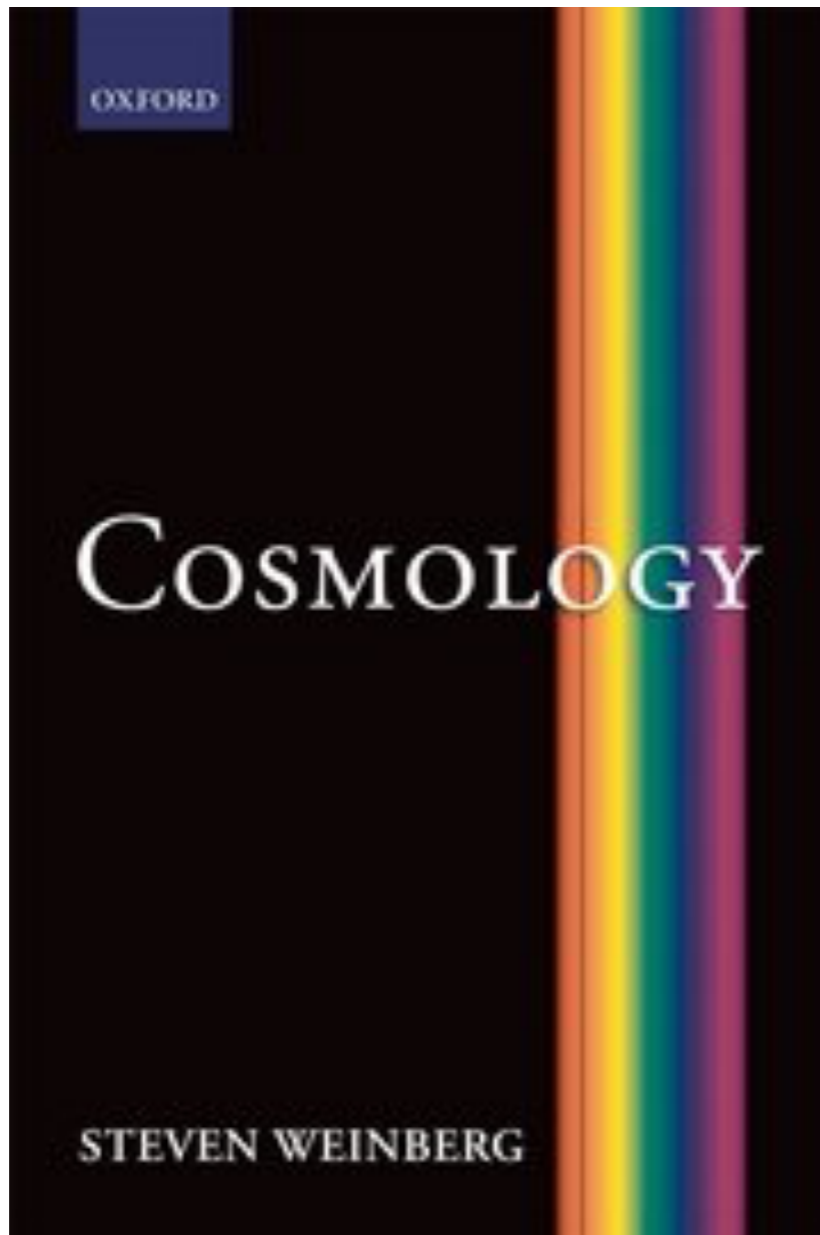



# Cosmological Parameters

- Unless stated otherwise, we shall assume a **spatially-flat  $\Lambda$  Cold Dark Matter** ( $\Lambda$ CDM) model with

$$\Omega_B h^2 = 0.022 \quad \text{[baryon density]}$$

$$\Omega_M h^2 = 0.14 \quad \text{[total mass density]}$$

$$\Omega_M = 0.3$$

which implies:

$$\Omega_\Lambda = 0.7, \quad \Omega_D h^2 = 0.118, \quad \Omega_B = 0.04714$$

$$H_0 = 100 h \text{ km s}^{-1} \text{ Mpc}^{-1}; \quad H_0 = 68.31 \text{ km s}^{-1} \text{ Mpc}^{-1}$$

# How light propagates in a clumpy universe?

- Photons gain/lose energy by **gravitational blue/redshifts**

this lecture

- Photons change their directions via **gravitational lensing**

not covered

# Distance between two points in space

- Static (i.e., non-expanding) Euclidean space
- In Cartesian coordinates  $\boldsymbol{x} = (x, y, z)$

$$ds^2 = dx^2 + dy^2 + dz^2$$

# Distance between two points in space

- Homogeneously expanding Euclidean space
- In Cartesian **comoving** coordinates  $x = (x, y, z)$

$$ds^2 = \boxed{a^2(t)} (dx^2 + dy^2 + dz^2)$$

“scale factor”

# Distance between two points in space

- Homogeneously expanding Euclidean space
- In Cartesian **comoving** coordinates  $x = (x, y, z)$

$$ds^2 = \boxed{a^2(t)} \sum_{i=1}^3 \sum_{j=1}^3 \delta_{ij} dx^i dx^j$$

**“scale factor”**

$\delta_{ij} = 1$  for  $i=j$   
 $= 0$  otherwise

# Distance between two points in space

- Inhomogeneous curved space
- In Cartesian **comoving** coordinates  $x = (x, y, z)$

$$ds^2 = a^2 \sum_{i=1}^3 \sum_{j=1}^3 (\delta_{ij} + \boxed{h_{ij}}) dx^i dx^j$$

“metric perturbation”

-> CURVED SPACE!

# Not just space...

- Einstein told us that a clock ticks slowly when gravity is strong...
- Space-time distance,  $ds_4$ , is modified by the presence of gravitational fields

$$ds_4^2 = -\exp(2\Phi)dt^2 + a^2 \exp(-2\Psi) \sum_{i=1}^3 \sum_{j=1}^3 [\exp(D)]_{ij} dx^i dx^j$$

$\Phi$  : Newton's gravitational potential

$\Psi$  : Spatial scalar curvature perturbation

$D_{ij}$  : Tensor metric perturbation [=gravitational waves]

# Tensor perturbation $D_{ij}$ : Area-conserving deformation

- Determinant of a matrix

$$[\exp(D)]_{ij} \equiv \delta_{ij} + D_{ij} + \frac{1}{2} \sum_{k=1}^3 D_{ik} D_{kj} + \frac{1}{6} \sum_{km} D_{ik} D_{km} D_{mj} + \dots$$

is given by  $\exp(\sum_i D_{ii})$

- **Thus,  $D_{ij}$  must be trace-less  $\sum_i D_{ii} = 0$**

**if it is area-conserving deformation of two points in space**





# Not just space...

- Einstein told us that a clock ticks slowly when gravity is strong...
- Space-time distance,  $ds_4$ , is modified by the presence of gravitational fields

$$ds_4^2 = -\exp(2\Phi)dt^2 + a^2 \exp(-2\Psi) \sum_{i=1}^3 \sum_{j=1}^3 [\exp(D)]_{ij} dx^i dx^j$$

$\Phi$  : Newton's gravitational potential

$\Psi$  : Spatial scalar curvature perturbation

is a perturbation to the determinant of spatial metric

# Evolution of photon's coordinates

- Photon's path is determined such that the distance traveled by a photon between two points is minimised. This yields the equation of motion for photon's coordinates  $x^\mu = (t, x^i)$

$$\frac{d^2 x^\lambda}{du^2} + \sum_{\mu=0}^3 \sum_{\nu=0}^3 \Gamma_{\mu\nu}^\lambda \frac{dx^\mu}{du} \frac{dx^\nu}{du} = 0$$

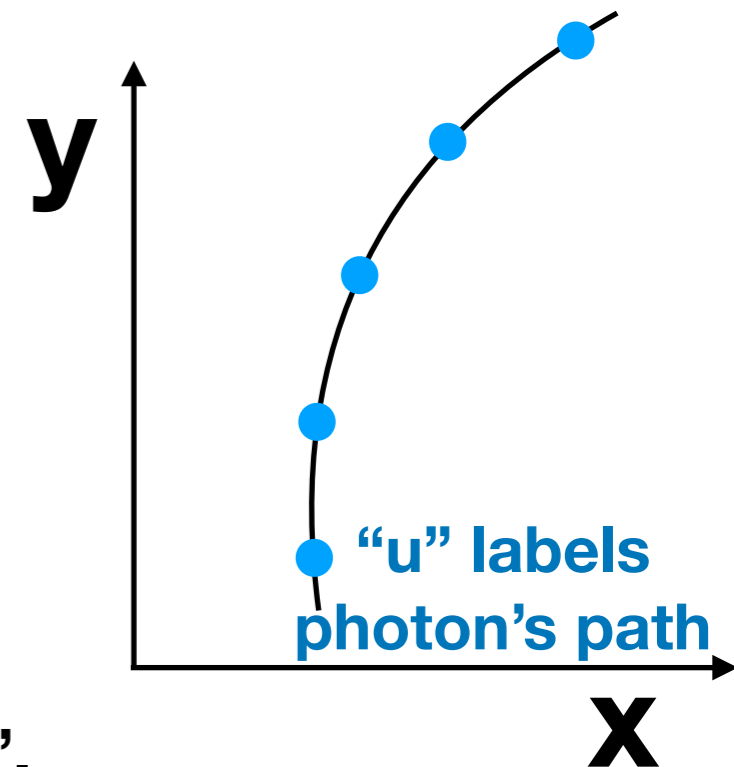

This equation is known as the “geodesic equation”.

**The second term is needed to keep the form of the equation unchanged under general coordinate transformation => GRAVITATIONAL EFFECTS!**

# Evolution of photon's momentum

- It is more convenient to write down the geodesic equation in terms of the **photon momentum**:

$$p^\mu \equiv \frac{dx^\mu}{du}$$

then

$$\frac{dp^\lambda}{dt} + \sum_{\mu=0}^3 \sum_{\nu=0}^3 \Gamma_{\mu\nu}^\lambda \frac{p^\mu p^\nu}{p^0} = 0$$

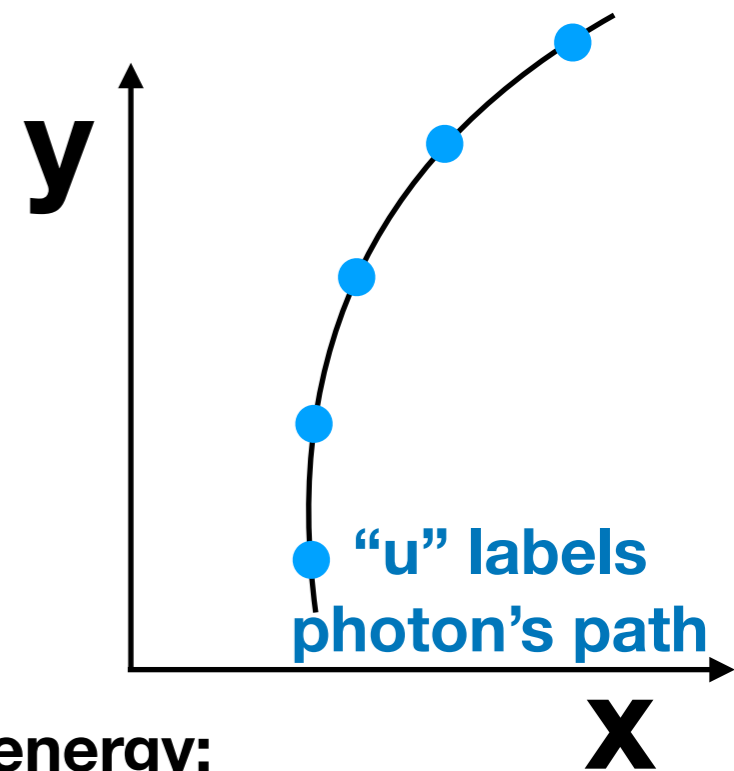

Magnitude of the photon momentum is equal to the photon energy:

$$p^2 \equiv \sum_{i=1}^3 \sum_{j=1}^3 g_{ij} p^i p^j$$

# Some calculations...

$$\frac{dp^\lambda}{dt} + \sum_{\mu=0}^3 \sum_{\nu=0}^3 \Gamma_{\mu\nu}^\lambda \frac{p^\mu p^\nu}{p^0} = 0$$

**With**  $ds_4^2 = \sum_{\mu\nu} g_{\mu\nu} dx^\mu dx^\nu$   $\left( \begin{array}{l} g_{00} = -\exp(2\Phi), \quad g_{0i} = 0, \\ g_{ij} = a^2 \exp(-2\Psi) [\exp(D)]_{ij} \end{array} \right)$

$$\Gamma_{\mu\nu}^\lambda \equiv \frac{1}{2} \sum_{\rho=0}^3 g^{\lambda\rho} \left( \frac{\partial g_{\rho\mu}}{\partial x^\nu} + \frac{\partial g_{\rho\nu}}{\partial x^\mu} - \frac{\partial g_{\mu\nu}}{\partial x^\rho} \right)$$

Scalar perturbation [valid to all orders]

Tensor perturbation [valid to 1st order in D]

$$\begin{aligned} \Gamma_{00}^0 &= \dot{\Phi}, & \Gamma_{0i}^0 &= \frac{\partial \Phi}{\partial x^i}, & \Gamma_{00}^i &= \exp(2\Phi) \sum_j g^{ij} \frac{\partial \Phi}{\partial x^j}, \\ \Gamma_{0j}^i &= \left( \frac{\dot{a}}{a} - \dot{\Psi} \right) \delta_j^i, & \Gamma_{ij}^0 &= \exp(-2\Phi) \left( \frac{\dot{a}}{a} - \dot{\Psi} \right) g_{ij}, \\ \Gamma_{ij}^k &= \delta_{ij} \sum_\ell \delta^{k\ell} \frac{\partial \Psi}{\partial x^\ell} - \delta_i^k \frac{\partial \Psi}{\partial x^j} - \delta_j^k \frac{\partial \Psi}{\partial x^i}, \end{aligned}$$

$$\begin{aligned} \Gamma_{0j}^i &= \frac{\dot{a}}{a} \delta_j^i + \frac{1}{2} \sum_k \delta^{ik} \dot{D}_{kj}, & \Gamma_{ij}^0 &= \frac{\dot{a}}{a} g_{ij} + \frac{a^2}{2} \dot{D}_{ij}, \\ \Gamma_{ij}^k &= \frac{1}{2} \sum_\ell \delta^{k\ell} \left( \frac{D_{i\ell}}{\partial x^j} + \frac{D_{\ell j}}{\partial x^i} - \frac{D_{ij}}{\partial x^\ell} \right), \end{aligned}$$



# Recap

*Math may be messy but the concept is transparent!*

- Requiring **photons to travel between two points in space-time with the minimum path length**, we obtained the geodesic equation
- The geodesic equation contains  $\Gamma_{\mu\nu}^{\lambda}$  that is required to make **the form of the equation unchanged under general coordinate transformation**
- Expressing  $\Gamma_{\mu\nu}^{\lambda}$  in terms of the metric perturbations, we obtain the desired result - **the equation that describes the rate of change of the photon energy!**

$$p^2 \equiv \sum_{i=1}^3 \sum_{j=1}^3 g_{ij} p^i p^j$$

# The Result

$$\frac{1}{p} \frac{dp}{dt} = -\frac{\dot{a}}{a} + \dot{\Psi} - \frac{1}{a} \sum_i \frac{\partial \Phi}{\partial x^i} \gamma^i - \frac{1}{2} \sum_{ij} \dot{D}_{ij} \gamma^i \gamma^j$$

$\gamma^i$  is a **unit vector** of the direction of photon's momentum:

$$\sum_i (\gamma^i)^2 = 1$$

- Let's interpret this equation *physically*

# The Result

$$\frac{1}{p} \frac{dp}{dt} = \boxed{-\frac{\dot{a}}{a}} + \dot{\Psi} - \frac{1}{a} \sum_i \frac{\partial \Phi}{\partial x^i} \gamma^i - \frac{1}{2} \sum_{ij} \dot{D}_{ij} \gamma^i \gamma^j$$

$\gamma^i$  is a **unit vector** of the direction of photon's momentum:

$$\sum_i (\gamma^i)^2 = 1$$

- **Cosmological redshift**

- Photon's wavelength is stretched in proportion to the scale factor, and thus the photon energy decreases as

$$p \propto a^{-1}$$



# The Result

$$\frac{1}{p} \frac{dp}{dt} = -\frac{\dot{a}}{a} \boxed{+ \dot{\Psi}} - \frac{1}{a} \sum_i \frac{\partial \Phi}{\partial x^i} \gamma^i - \frac{1}{2} \sum_{ij} \dot{D}_{ij} \gamma^i \gamma^j$$

- **Cosmological redshift - part II**

- The spatial metric is given by  $ds^2 = a^2(t) \exp(-2\Psi) d\mathbf{x}^2$
- Thus, locally we can define a new scale factor:
 
$$\tilde{a}(t, \mathbf{x}) = a(t) \exp(-\Psi)$$
- Then the photon momentum decreases as

$$p \propto \tilde{a}^{-1}$$

# The Result

$$\frac{1}{p} \frac{dp}{dt} = -\frac{\dot{a}}{a} + \dot{\Psi} \left[ -\frac{1}{a} \sum_i \frac{\partial \Phi}{\partial x^i} \gamma^i \right] - \frac{1}{2} \sum_{ij} \dot{D}_{ij} \gamma^i \gamma^j$$

- Gravitational **blue/redshift** (**Scalar**)

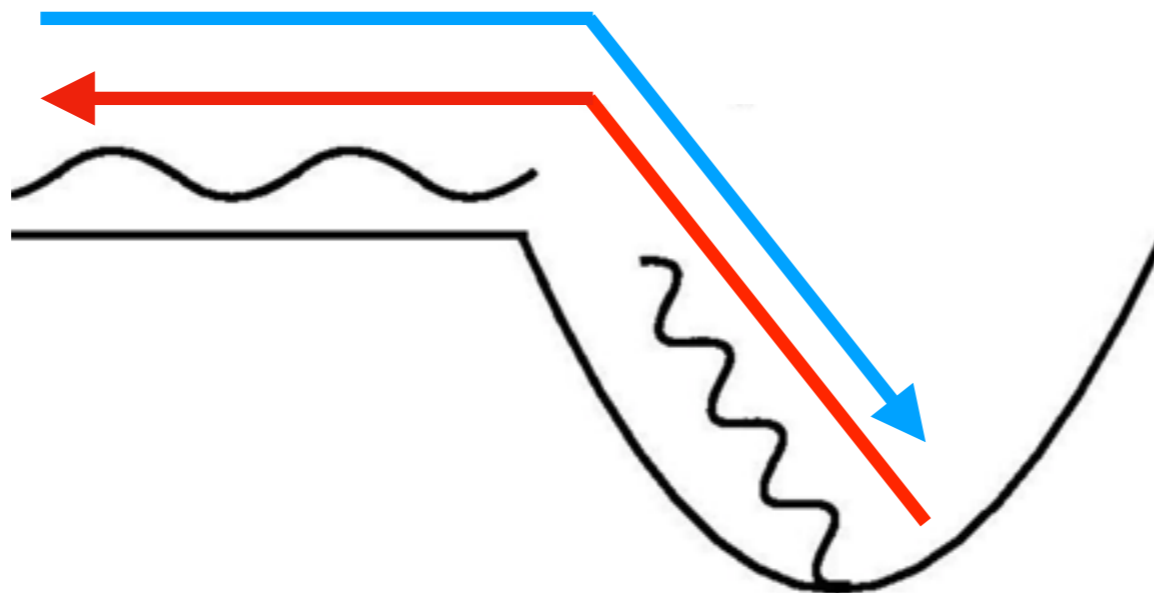

**Potential well ( $\phi < 0$ )**

# The Result

$$\frac{1}{p} \frac{dp}{dt} = -\frac{\dot{a}}{a} + \dot{\Psi} - \frac{1}{a} \sum_i \frac{\partial \Phi}{\partial x^i} \gamma^i - \frac{1}{2} \sum_{ij} \dot{D}_{ij} \gamma^i \gamma^j$$

- Gravitational **blue/redshift** (**Tensor**)

$$D_{ij} = \begin{pmatrix} h_+ & h_\times & 0 \\ h_\times & -h_+ & 0 \\ 0 & 0 & 0 \end{pmatrix}$$

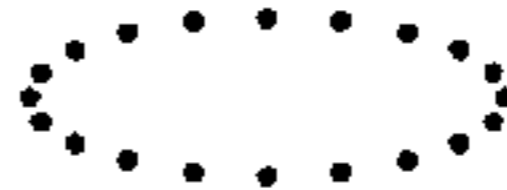

# The Result

$$\frac{1}{p} \frac{dp}{dt} = -\frac{\dot{a}}{a} + \dot{\Psi} - \frac{1}{a} \sum_i \frac{\partial \Phi}{\partial x^i} \gamma^i - \frac{1}{2} \sum_{ij} \dot{D}_{ij} \gamma^i \gamma^j$$

- Gravitational **blue/redshift** (Tensor)

$$D_{ij} = \begin{pmatrix} h_+ & h_\times & 0 \\ h_\times & -h_+ & 0 \\ 0 & 0 & 0 \end{pmatrix}$$

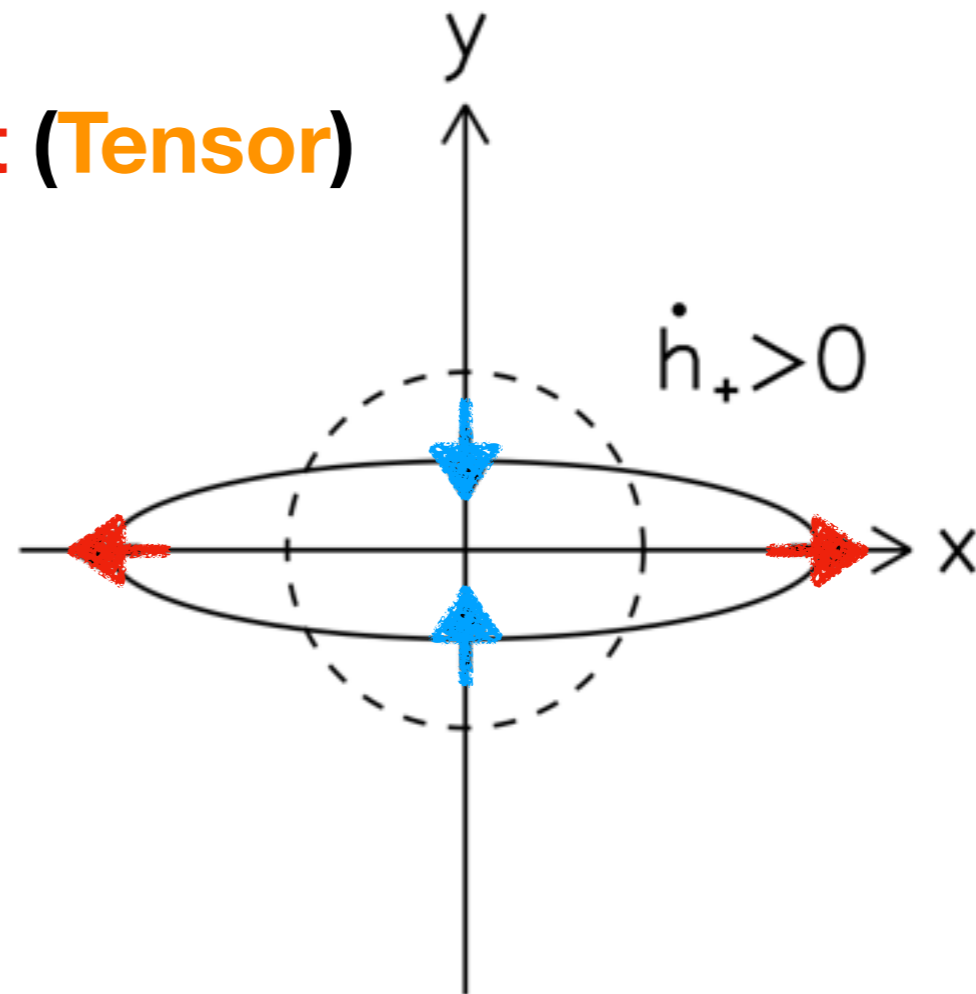



# Formal Solution (Scalar)

$$\ln(ap)(t_0) = \ln(ap)(t_L) + \Phi(t_L) - \Phi(t_0) + \int_{t_L}^{t_0} dt (\dot{\Phi} + \dot{\Psi})$$

or

$$\frac{\Delta T(\hat{n})}{T_0} = \frac{\delta T(t_L, \hat{n}r_L)}{\bar{T}(t_L)} + \Phi(t_L, \hat{n}r_L) - \Phi(t_0, 0)$$

$$+ \int_{t_L}^{t_0} dt (\dot{\Phi} + \dot{\Psi})(t, \hat{n}r)$$

$$\frac{1}{a} \sum_i \frac{\partial \Phi}{\partial x^i} \gamma^i = \frac{d\Phi}{dt} - \dot{\Phi}$$

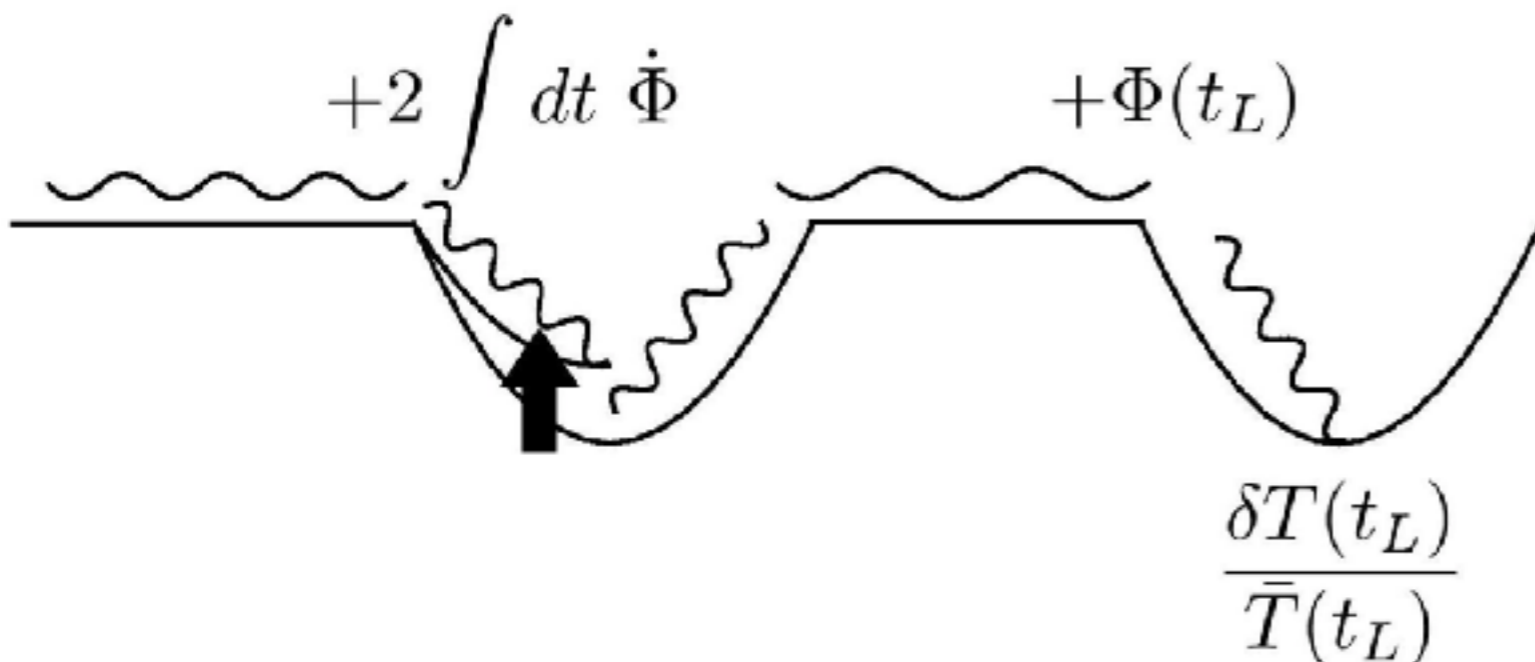

**Line-of-sight direction**

$$\hat{n}^i = -\gamma^i$$

**Coming distance (r)**

$$x^i = \hat{n}^i r$$

$$r(t) = \int_t^{t_0} \frac{dt'}{a(t')}$$

# Formal Solution (Scalar)

Initial Condition

$$\frac{\Delta T(\hat{n})}{T_0} = \frac{\delta T(t_L, \hat{n}r_L)}{\bar{T}(t_L)} + \Phi(t_L, \hat{n}r_L) - \Phi(t_0, 0)$$

$$+ \int_{t_L}^{t_0} dt (\dot{\Phi} + \dot{\Psi})(t, \hat{n}r)$$

$$+ 2 \int dt \dot{\Phi} + \Phi(t_L)$$

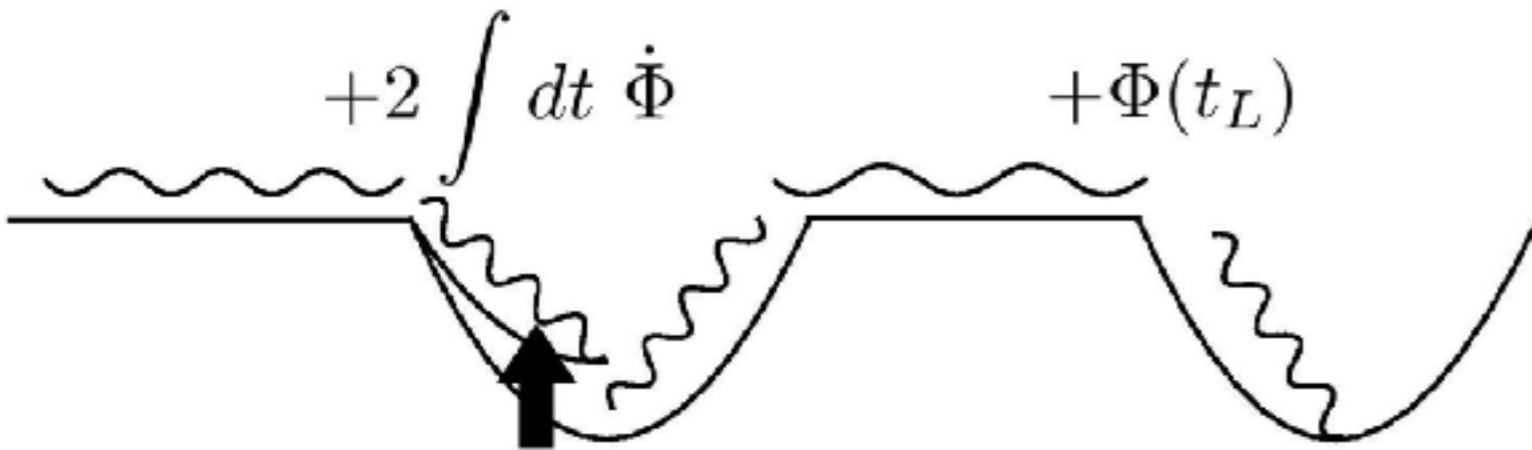

$$\frac{\delta T(t_L)}{\bar{T}(t_L)}$$

Line-of-sight direction

$$\hat{n}^i = -\gamma^i$$

Coming distance (r)

$$x^i = \hat{n}^i r$$

$$r(t) = \int_t^{t_0} \frac{dt'}{a(t')}$$

# Formal Solution (Scalar)

Gravitational Redshift

$$\frac{\Delta T(\hat{n})}{T_0} = \frac{\delta T(t_L, \hat{n}r_L)}{\bar{T}(t_L)} + \Phi(t_L, \hat{n}r_L) - \Phi(t_0, 0)$$

$$+ \int_{t_L}^{t_0} dt (\dot{\Phi} + \dot{\Psi})(t, \hat{n}r)$$

$$+ 2 \int dt \dot{\Phi}$$

$$+ \Phi(t_L)$$

$$\frac{\delta T(t_L)}{\bar{T}(t_L)}$$

Line-of-sight direction

$$\hat{n}^i = -\gamma^i$$

Comoving distance (r)

$$x^i = \hat{n}^i r$$

$$r(t) = \int_t^{t_0} \frac{dt'}{a(t')}$$

# Formal Solution (Scalar)

$$\frac{\Delta T(\hat{n})}{T_0} = \frac{\delta T(t_L, \hat{n}r_L)}{\bar{T}(t_L)} + \Phi(t_L, \hat{n}r_L) - \Phi(t_0, 0)$$

“integrated Sachs-Wolfe” (ISW) effect

$$+ \int_{t_L}^{t_0} dt (\dot{\Phi} + \dot{\Psi})(t, \hat{n}r)$$

$$+ 2 \int dt \dot{\Phi}$$

$$+ \Phi(t_L)$$

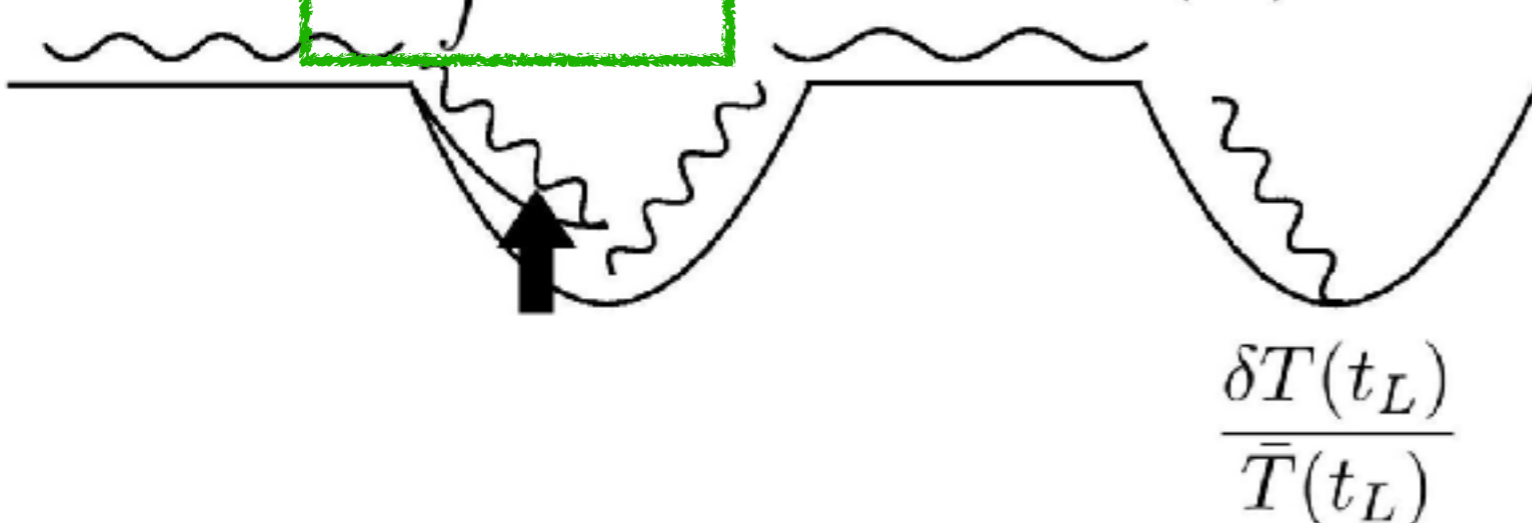

**Line-of-sight direction**

$$\hat{n}^i = -\gamma^i$$

**Coming distance (r)**

$$x^i = \hat{n}^i r$$

$$r(t) = \int_t^{t_0} \frac{dt'}{a(t')}$$



# Initial Condition

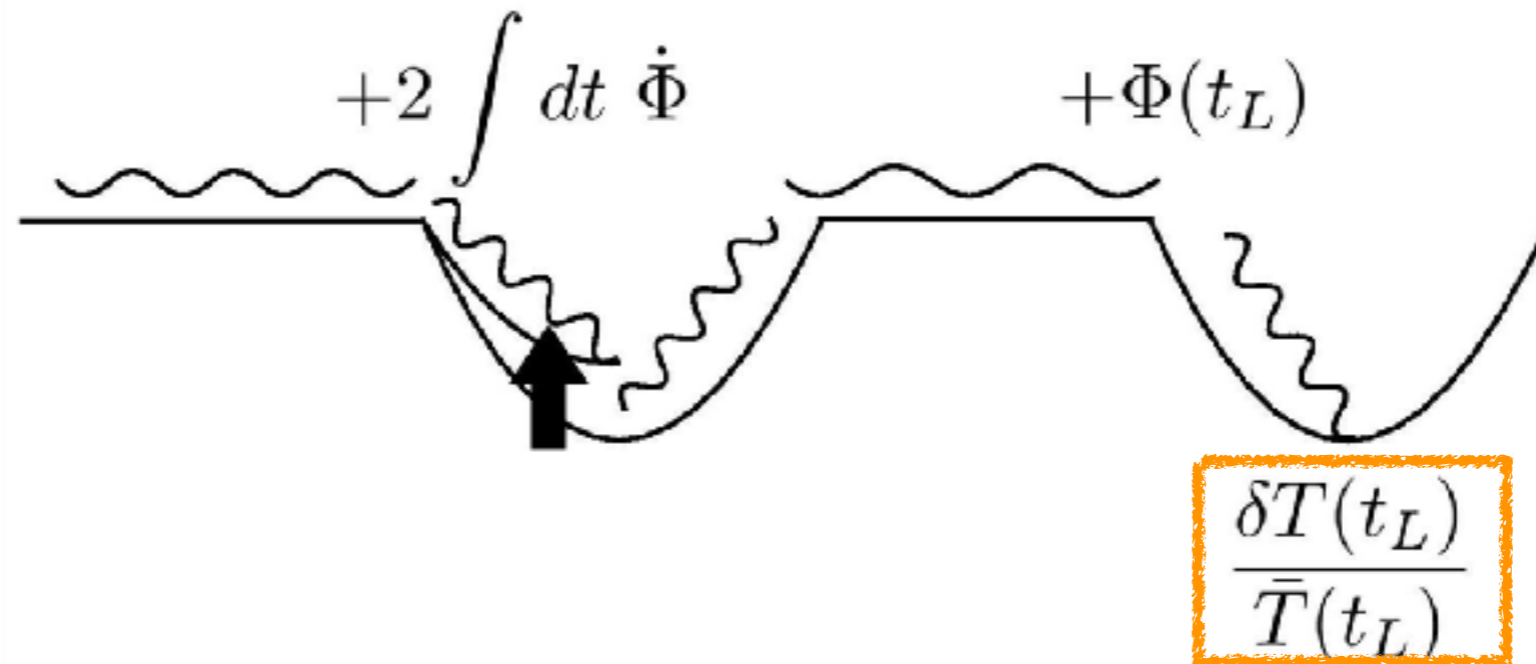

- "Were photons hot or cold at the bottom of the potential well at the last scattering surface?"
- This must be assumed a priori - **only the data can tell us!**

# “Adiabatic” Initial Condition

- Definition: “*Ratios of the number densities of all species are equal everywhere initially*”

- For  $i^{\text{th}}$  and  $j^{\text{th}}$  species,  $n_i(\mathbf{x})/n_j(\mathbf{x}) = \text{constant}$

- For a quantity  $X(t, \mathbf{x})$ , let us define the **fluctuation**,  $\delta X$ , as

$$\delta X(t, \mathbf{x}) \equiv X(t, \mathbf{x}) - \bar{X}(t)$$

- Then, the adiabatic initial condition is

$$\frac{\delta n_i(t_{\text{initial}}, \mathbf{x})}{\bar{n}_i(t_{\text{initial}})} = \frac{\delta n_j(t_{\text{initial}}, \mathbf{x})}{\bar{n}_j(t_{\text{initial}})}$$

# Example:

## Thermal Equilibrium

- When photons and baryons were in thermal equilibrium in the past, then
  - $n_{\text{photon}} \sim T^3$  and  $n_{\text{baryon}} \sim T^3$
  - That is to say, **thermal equilibrium naturally gives the adiabatic initial condition**

- This gives 
$$3 \frac{\delta T(t_i, \boldsymbol{x})}{\bar{T}(t_i)} = \frac{\delta \rho_B(t_i, \boldsymbol{x})}{\bar{\rho}_B(t_i)}$$

- “B” for “Baryons”
- $\rho$  is the mass density

# Big Question

- *How about dark matter?*
- If dark matter and photons were in thermal equilibrium in the past, then they should also obey the adiabatic initial condition
  - If not, *there is no a priori reason to expect the adiabatic initial condition!*
- The current data are consistent with the adiabatic initial condition. This means something important for the nature of dark matter!

**We shall assume the adiabatic initial condition throughout the lectures**



# Adiabatic Solution

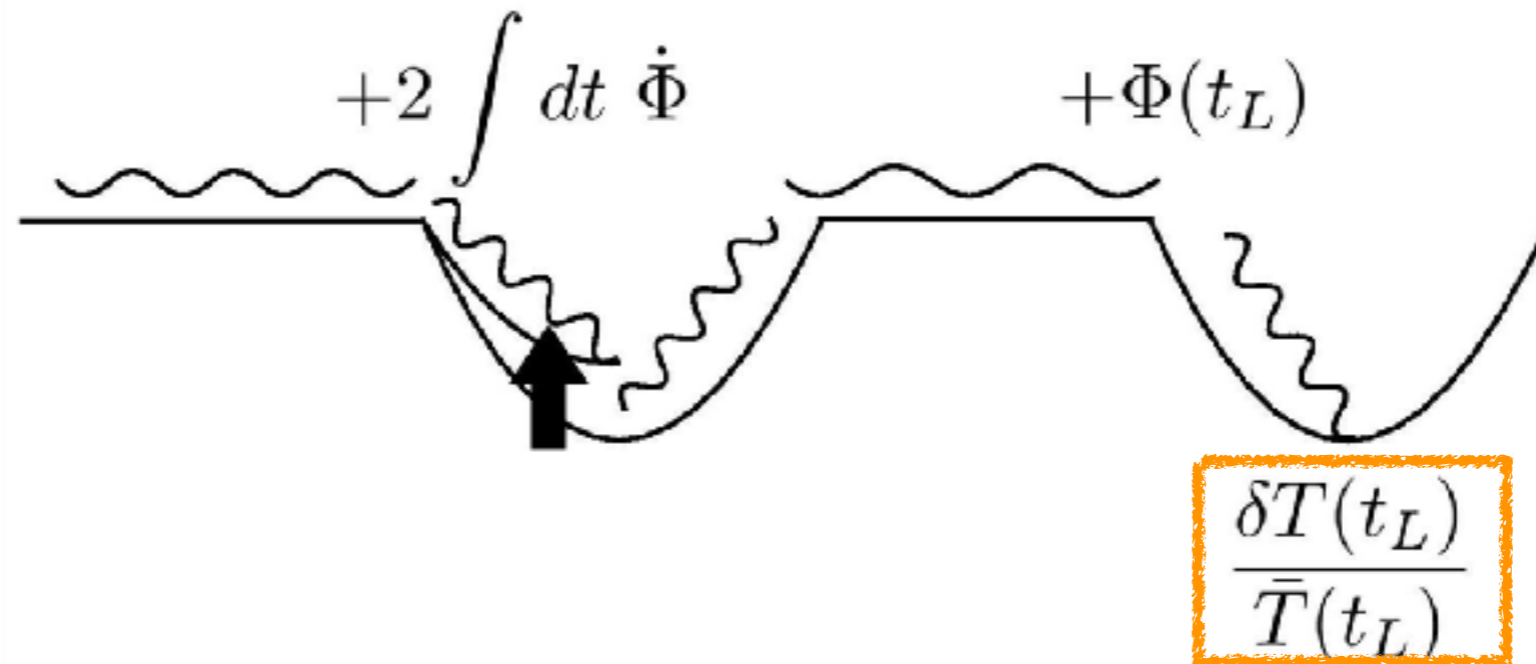

- At the last scattering surface, the temperature fluctuation is given by the matter density fluctuation as

$$\frac{\delta T(t_L, \mathbf{x})}{\bar{T}(t_L)} = \frac{1}{3} \frac{\delta \rho_M(t_L, \mathbf{x})}{\bar{\rho}_M(t_L)}$$

# Adiabatic Solution

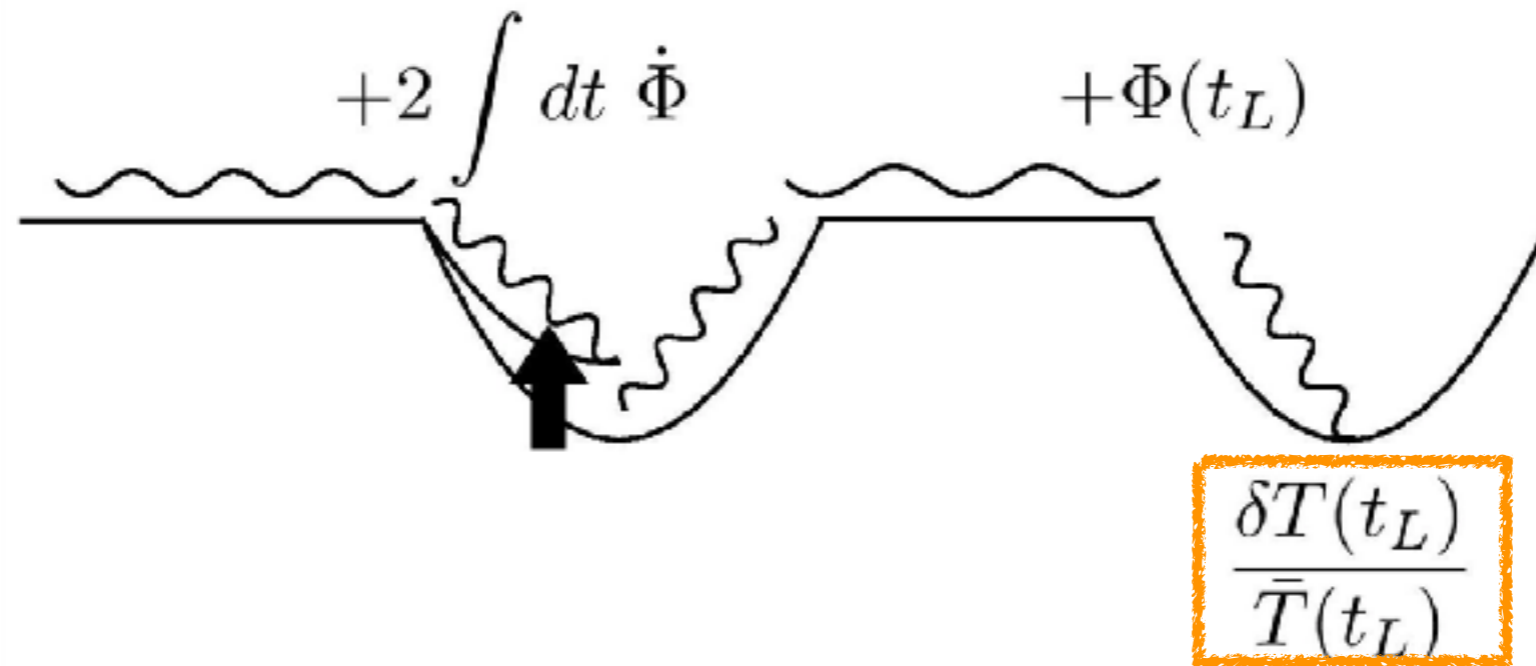

- On large scales, the matter density fluctuation during the matter-dominated era is given by  $\delta\rho_M/\bar{\rho}_M = -2\Phi$ ; thus,

$$\frac{\delta T(t_L, \mathbf{x})}{\bar{T}(t_L)} = \frac{1}{3} \frac{\delta\rho_M(t_L, \mathbf{x})}{\bar{\rho}_M(t_L)} = -\frac{2}{3} \Phi(t_L, \mathbf{x})$$

**Hot at the bottom of the potential well, but...**

# Over-density = Cold spot

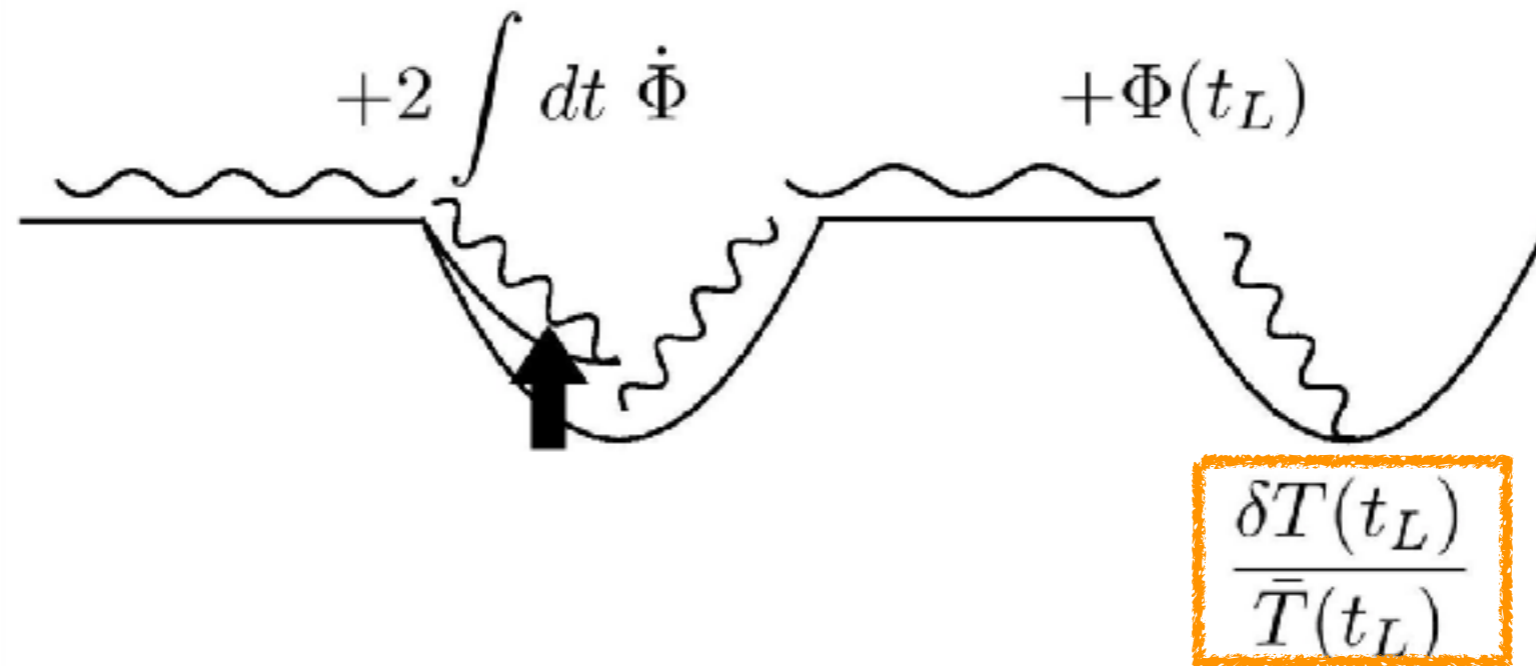

- Therefore: 
$$\frac{\Delta T(\hat{n})}{T_0} = \frac{1}{3} \Phi(t_L, \hat{r}_L)$$

**This is negative in an over-density region!**



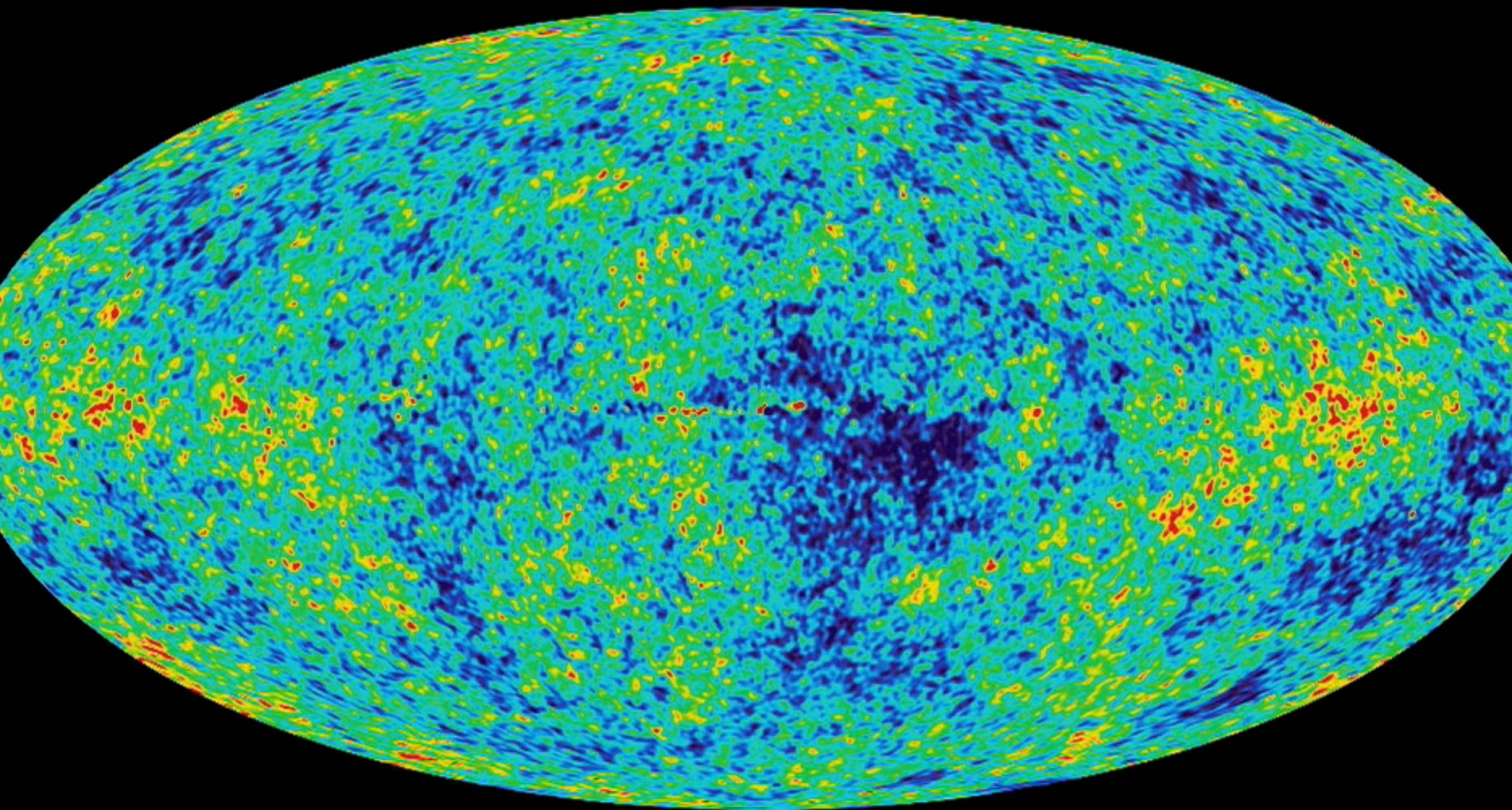



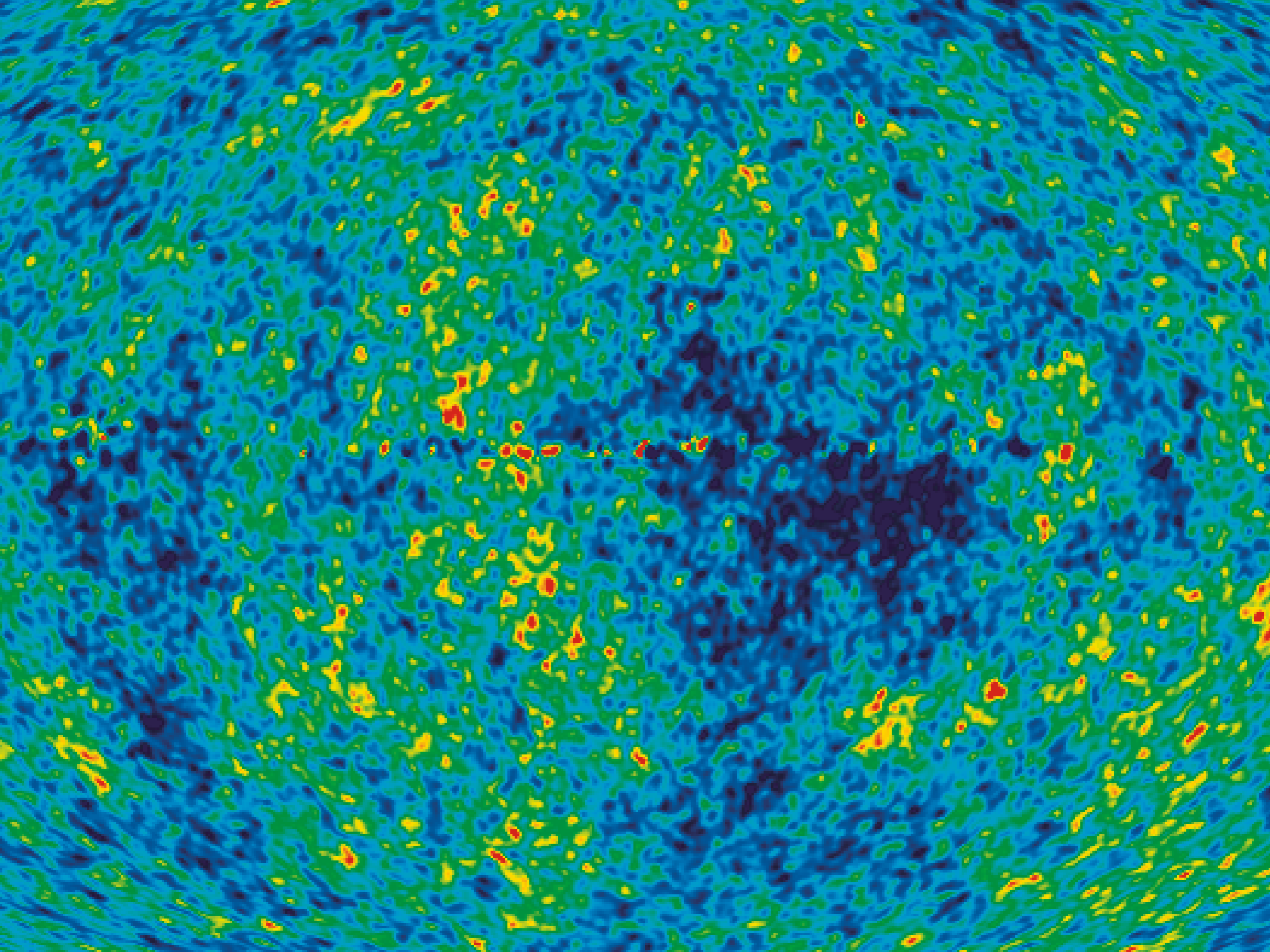

# Data Analysis

- Decompose temperature fluctuations in the sky into a set of waves with various wavelengths
- Make a diagram showing the strength of each wavelength

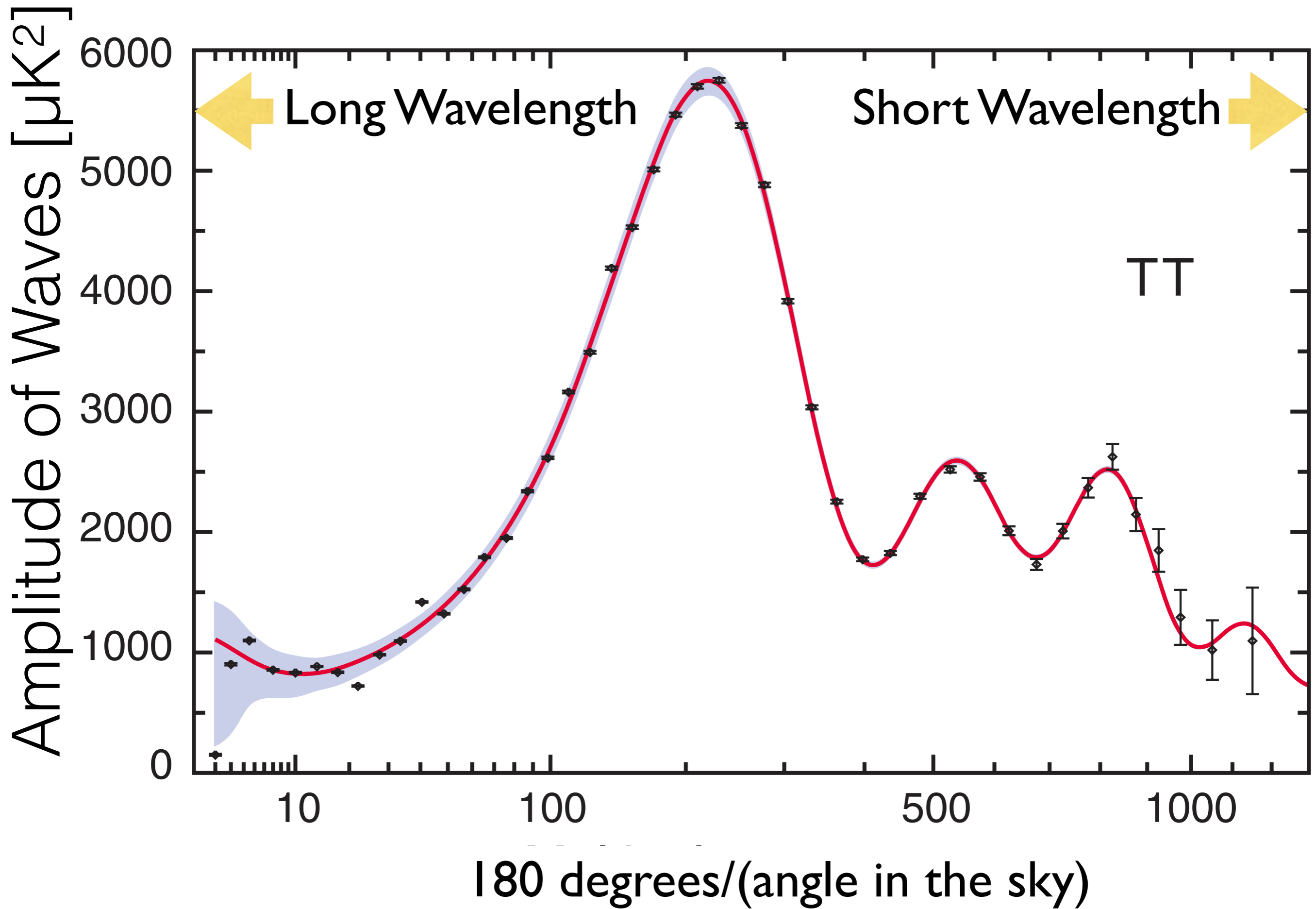

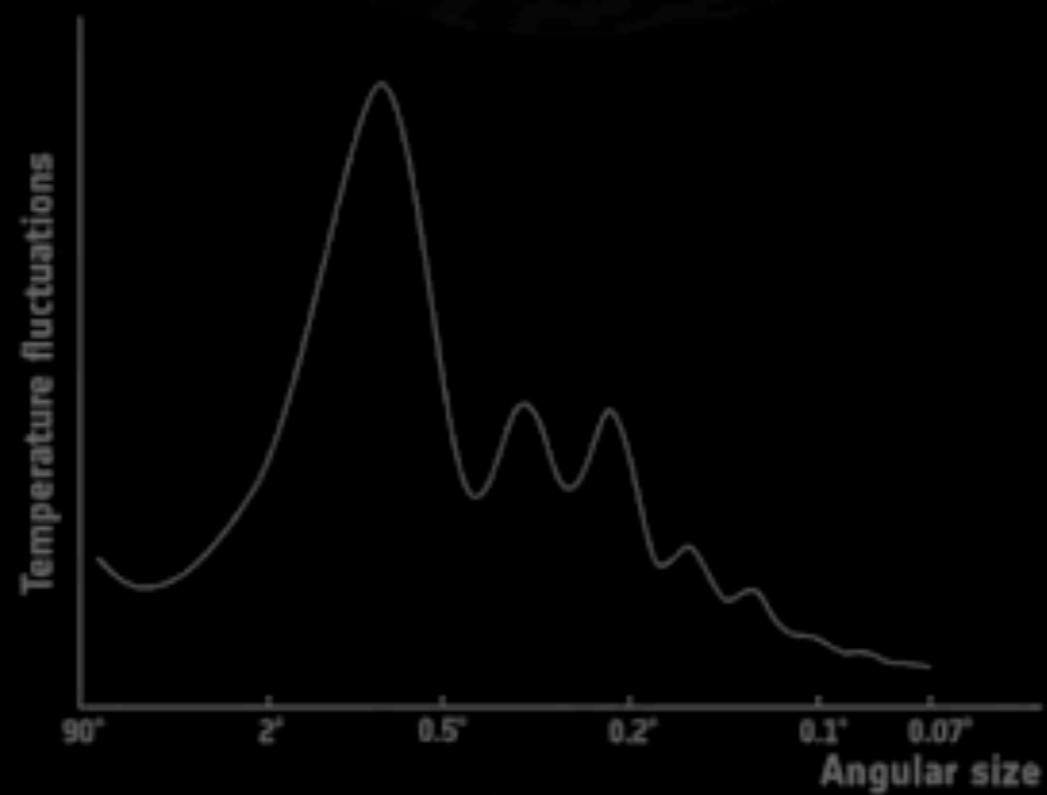





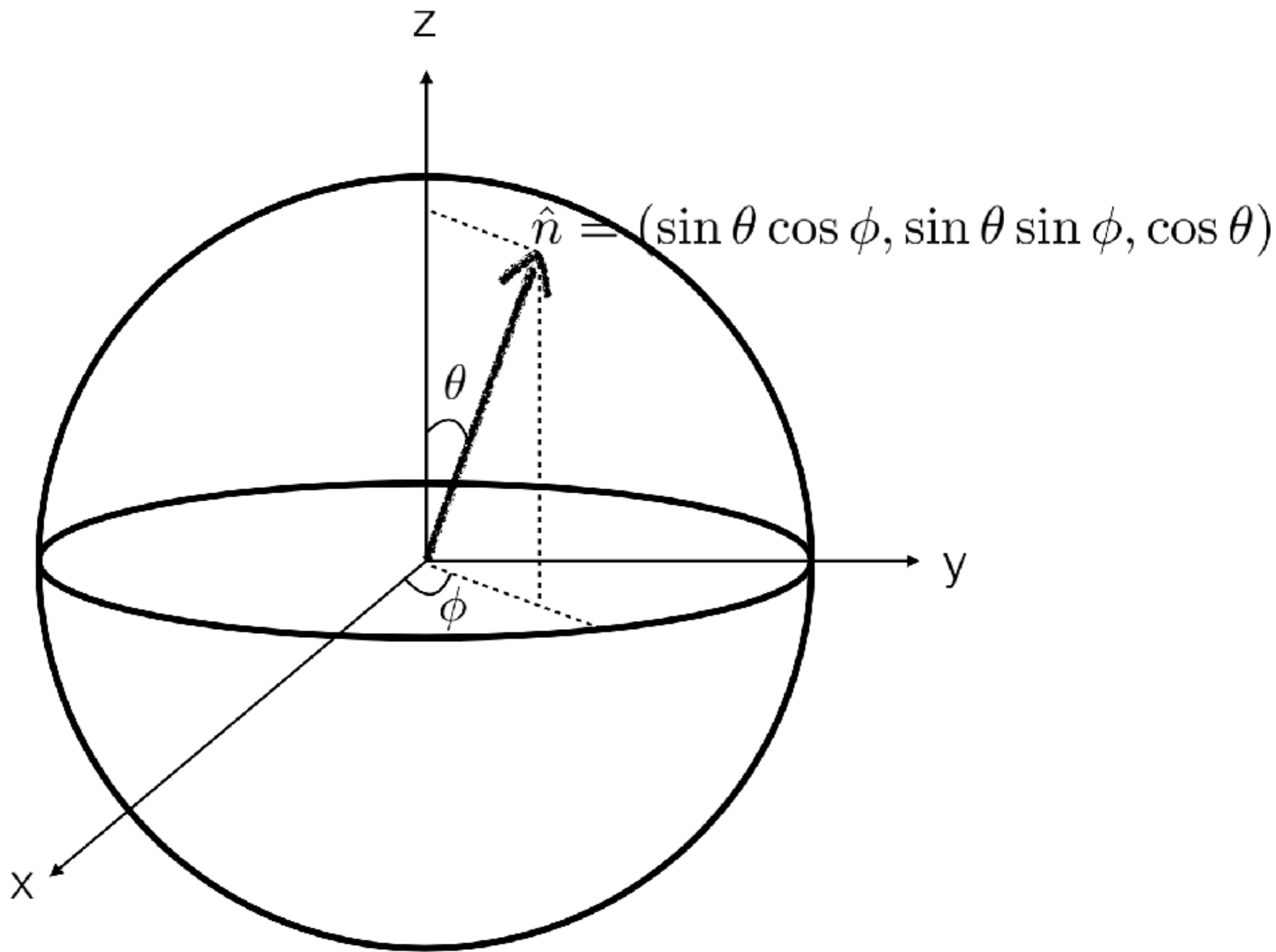

# Spherical Harmonic Transform

$$\Delta T(\hat{n}) = \sum_{\ell=1}^{\infty} \sum_{m=-\ell}^{\ell} a_{\ell m} Y_{\ell}^m(\hat{n})$$

- Values of  $a_{\ell m}$  depend on coordinates, but the squared amplitude,  $\sum_{m=-\ell}^{\ell} a_{\ell m} a_{\ell m}^*$ , does not depend on coordinates

$(l,m)=(1,0)$

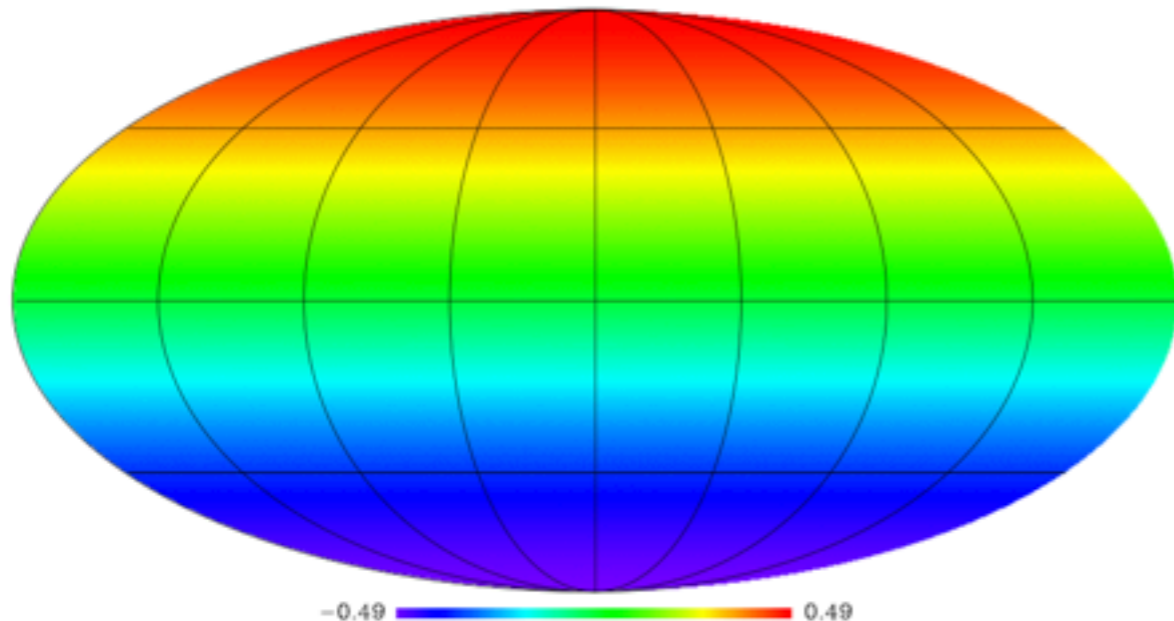

$(l,m)=(1,1)$

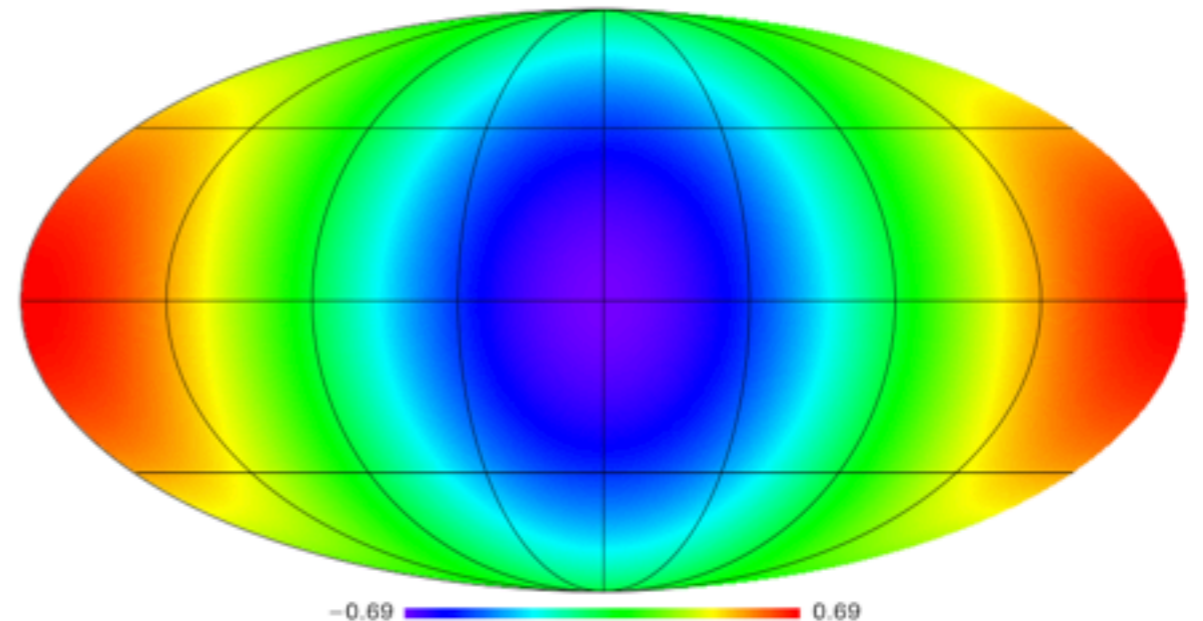

$(l,m)=(2,0)$

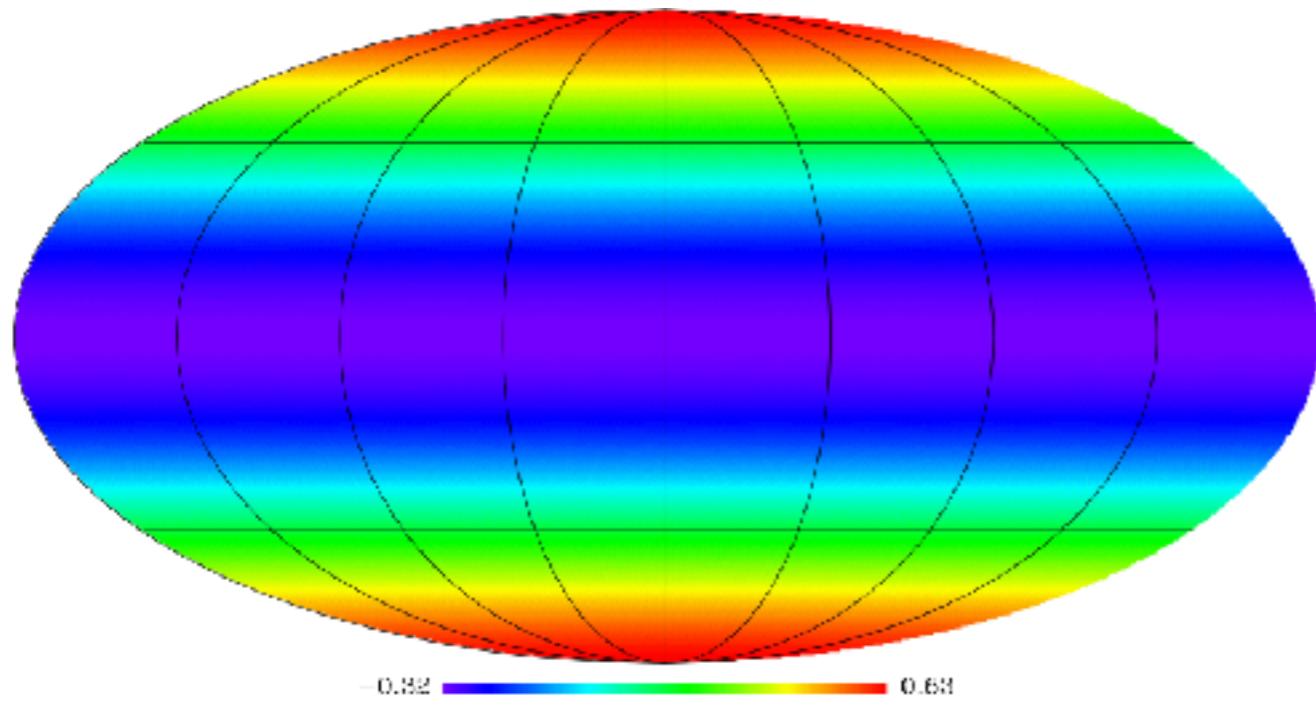

$(l,m)=(2,1)$

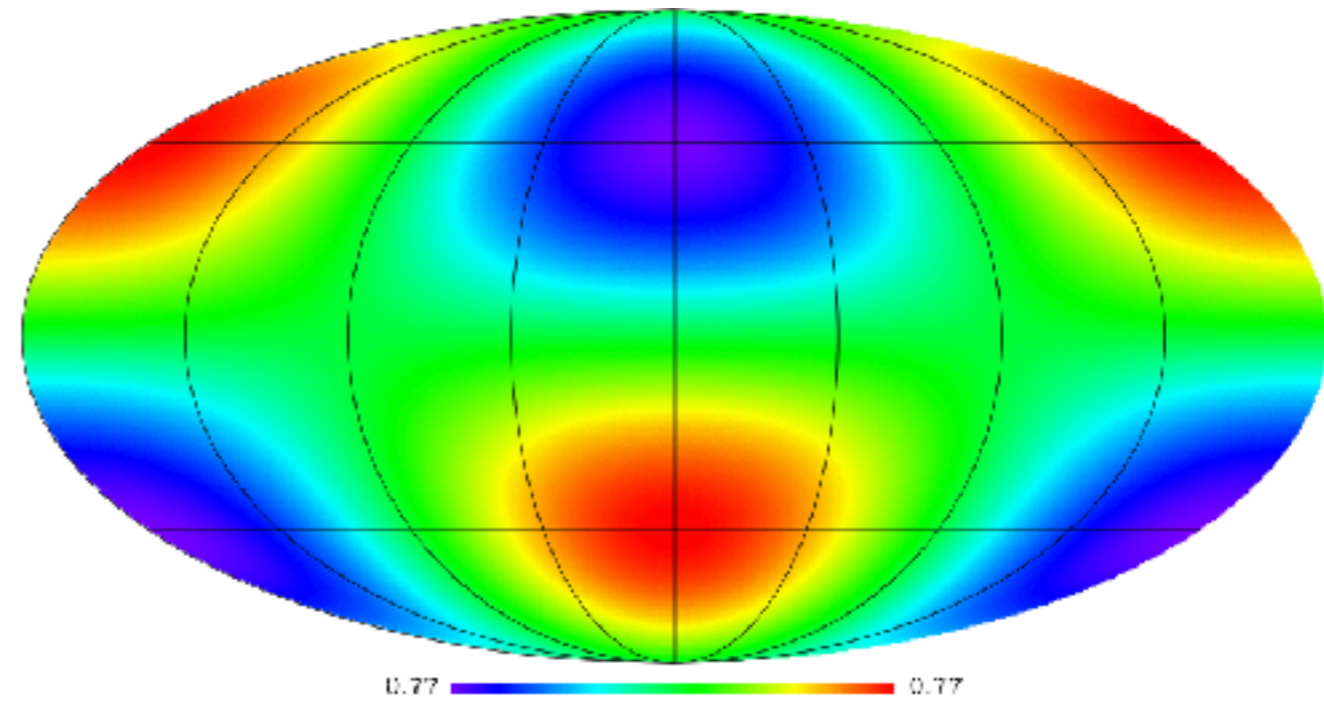

$(l,m)=(2,2)$

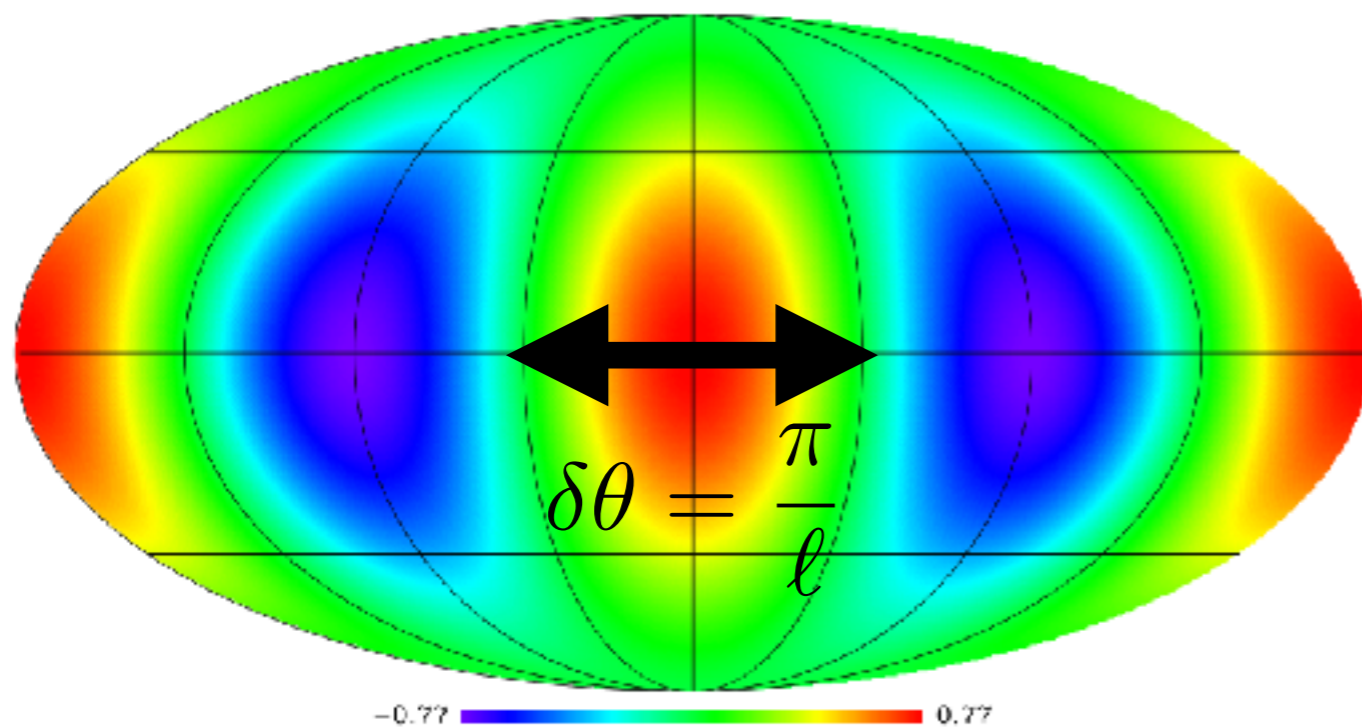

For  $l=m$ , a half-wavelength,  $\lambda_\theta/2$ , corresponds to  $\pi/l$ .  
Therefore,  $\lambda_\theta = 2\pi/l$



$(l,m)=(3,0)$

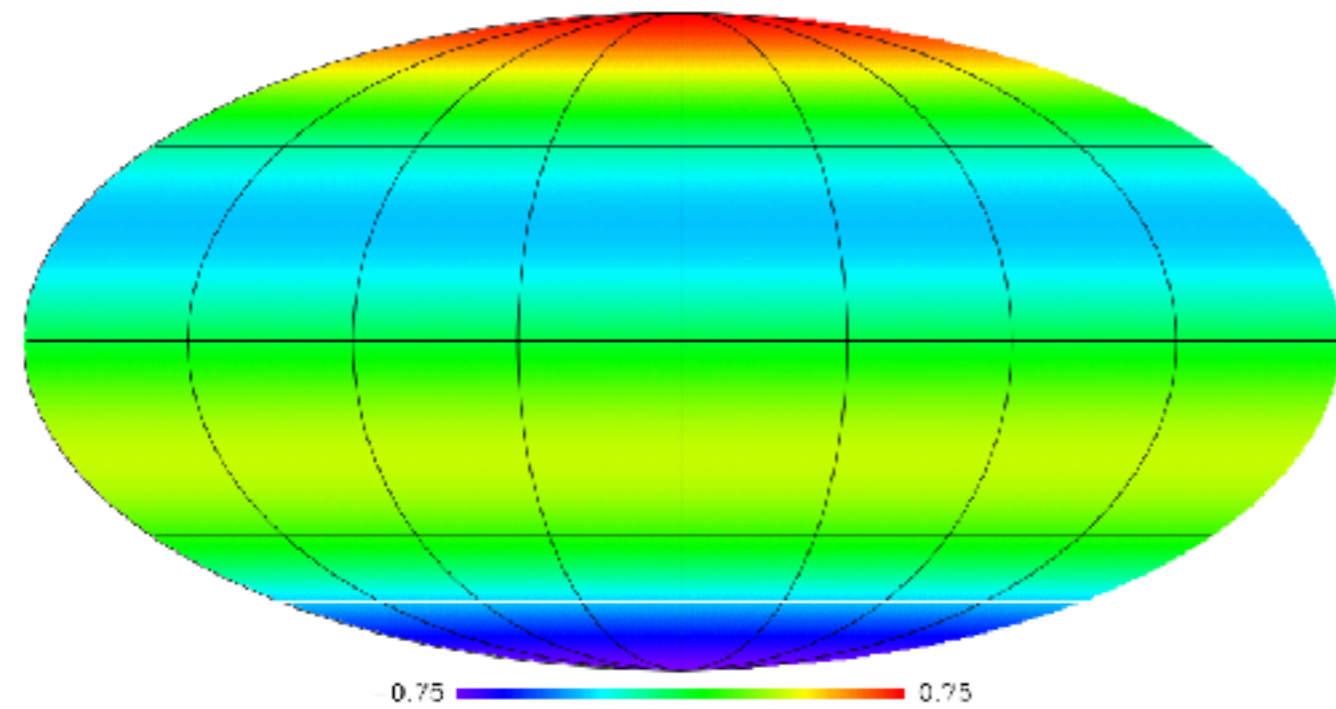

$(l,m)=(3,1)$

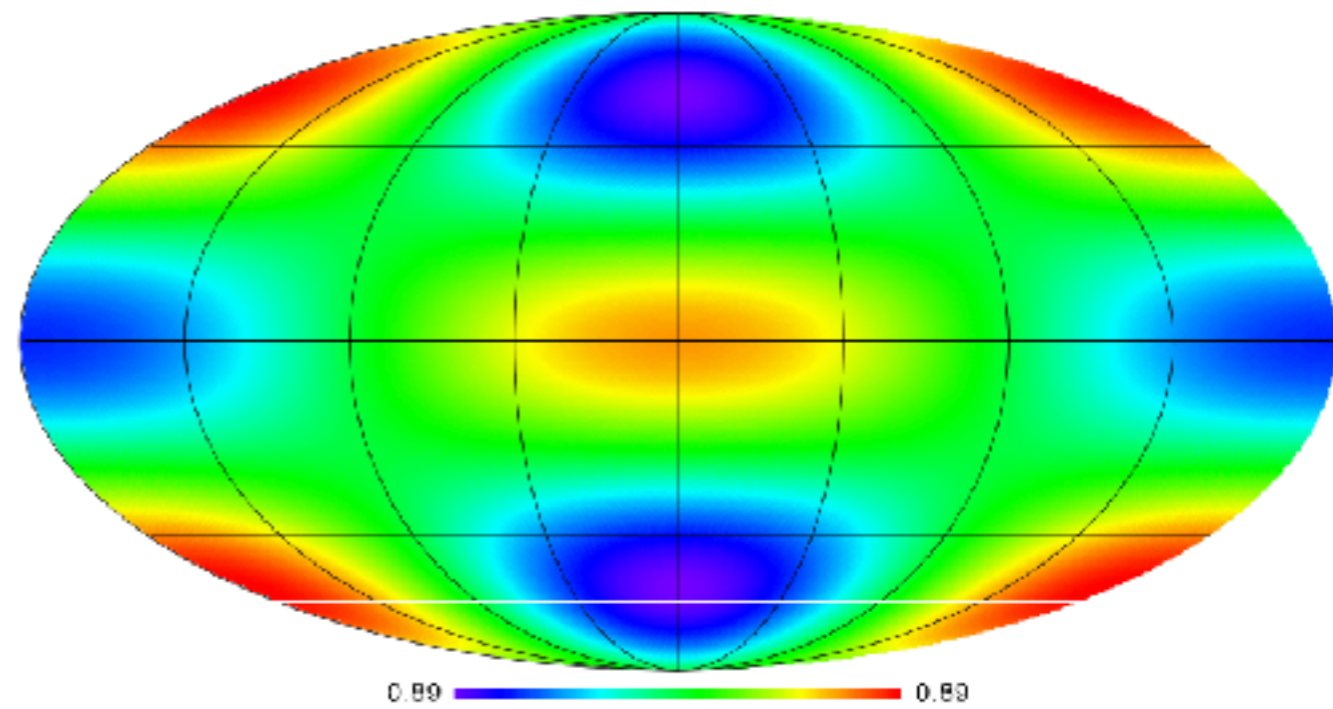

$(l,m)=(3,2)$

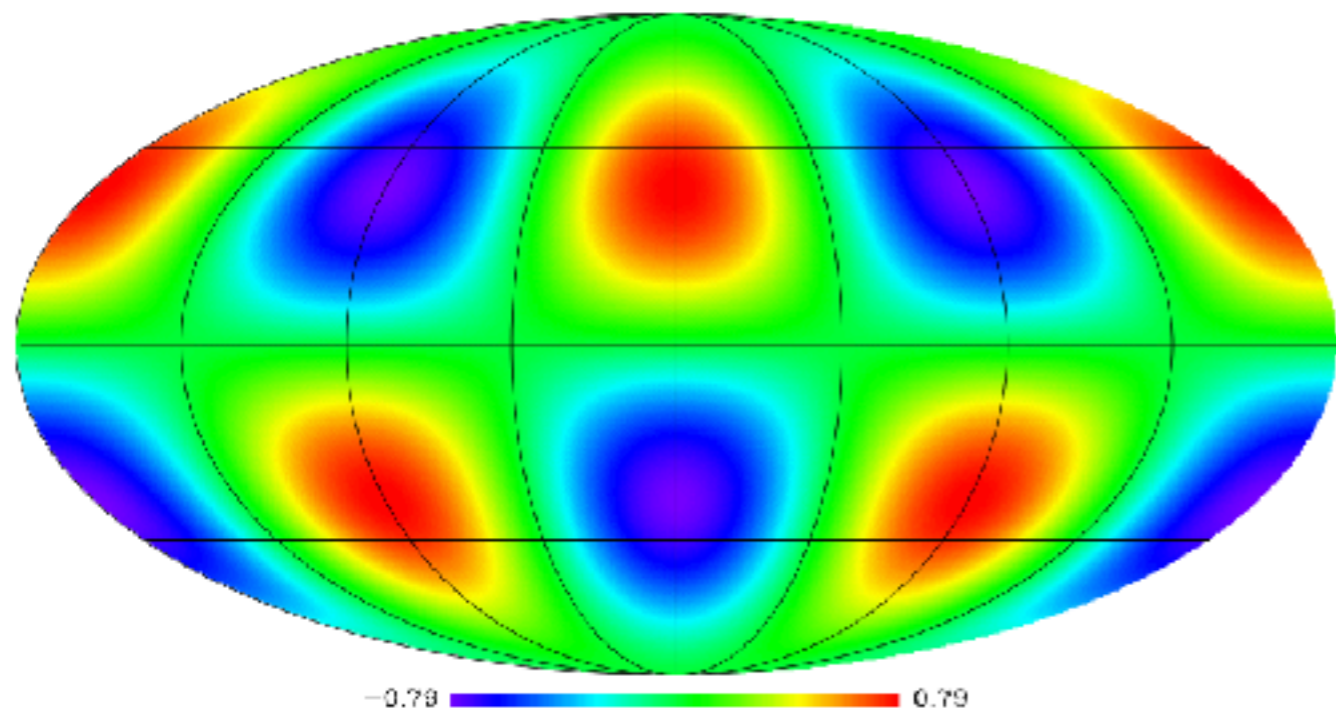

$(l,m)=(3,3)$

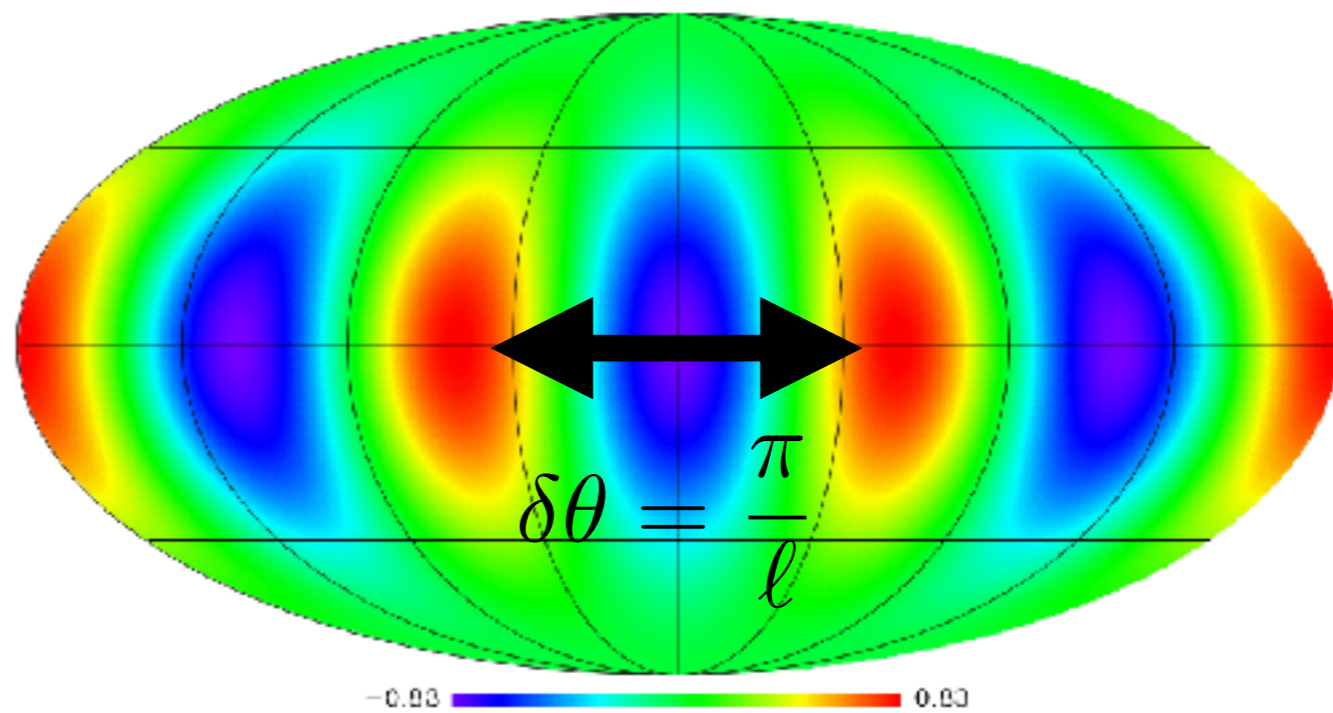

# $a_{lm}$ of the SW effect

- Using the inverse transform  $a_{lm} = \int d\Omega \Delta T(\hat{n}) Y_\ell^{m*}(\hat{n})$  on the Sachs-Wolfe (SW) formula  $\frac{\Delta T(\hat{n})}{T_0} = \frac{1}{3} \Phi(t_L, \hat{r}_L)$

and Fourier-transforming the potential, we obtain:

$$a_{lm}^{\text{SW}} = \frac{T_0}{3} \int d\Omega Y_\ell^{m*}(\hat{n}) \int \frac{d^3 q}{(2\pi)^3} \Phi_{\mathbf{q}} \exp(i\mathbf{q} \cdot \hat{n} r_L)$$

\* $\mathbf{q}$  is the 3d Fourier wavenumber

The left hand side is the coefficients of 2d spherical waves, whereas the right hand side is the coefficients of 3d plane waves. How can we make the connection?

# Spherical wave decomposition of a plane wave

$$\exp(i\mathbf{q} \cdot \hat{\mathbf{n}}r_L) = 4\pi \sum_{\ell=0}^{\infty} i^{\ell} j_{\ell}(qr_L) \sum_{m=-\ell}^{\ell} Y_{\ell}^m(\hat{\mathbf{n}}) Y_{\ell}^{m*}(\hat{\mathbf{q}})$$

- This “partial-wave decomposition formula” (or Rayleigh’s formula) then gives

$$a_{\ell m}^{\text{SW}} = \frac{4\pi T_0 i^{\ell}}{3} \int \frac{d^3 q}{(2\pi)^3} \Phi_{\mathbf{q}} j_{\ell}(qr_L) Y_{\ell}^{m*}(\hat{\mathbf{q}})$$

- This is the exact formula relating 3d potential at the last scattering surface onto  $a_{\ell m}$ . **How do we understand this?**

# q -> l projection

$$a_{\ell m}^{\text{SW}} = \frac{4\pi T_0 i^\ell}{3} \int \frac{d^3 q}{(2\pi)^3} \Phi_q j_\ell(qr_L) Y_\ell^{m*}(\hat{q})$$

- A half wavelength,  $\lambda/2$ , at the last scattering surface subtends an angle of  $\lambda/2r_L$ . Since  $q=2\pi/\lambda$ , the angle is given by  $\delta\theta=\pi/qr_L$ . Comparing this with the relation  $\delta\theta=\pi/l$  (for  $l=m$ ), we obtain  **$l=qr_L$** . How can we see this?
- For  $l \gg 1$ , the spherical Bessel function,  **$j_l(qr_L)$** , **peaks at  $l=qr_L$**  and falls gradually toward  $qr_L > l$ . Thus, a given  $q$  mode contributes to large angular scales too.



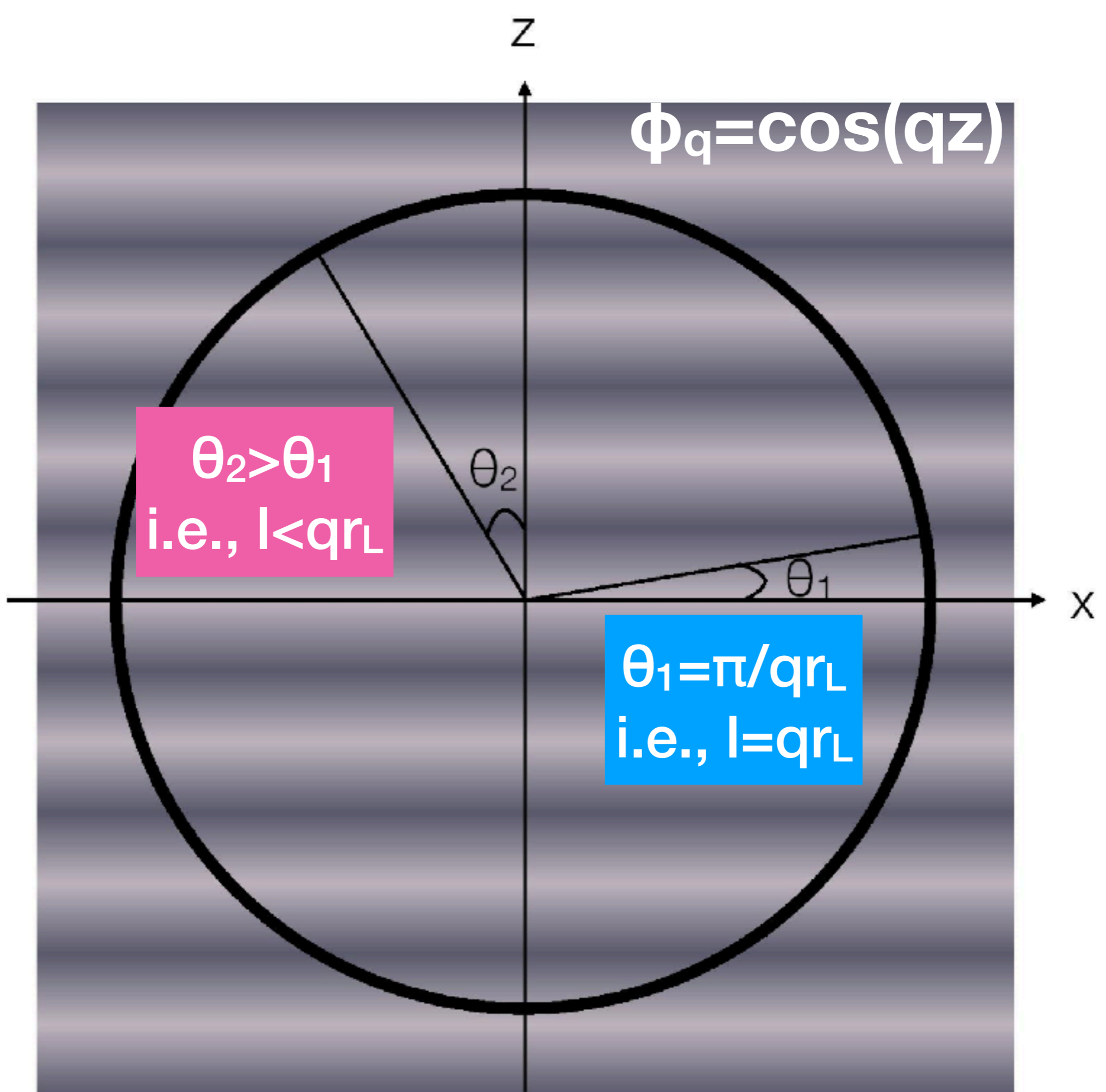

# More intuitive approach: Flay-sky Approximation

- Not all of us are familiar with spherical bessel functions...
- The fundamental complication here is that we are trying to relate a 3d plane wave with a spherical wave.
- More intuitive approach would be to relate a 3d plane wave with **a 2d plane wave**

# Decomposition

- Full sky
  - Decompose temperature fluctuations using **spherical harmonics**
- Flat sky
  - Decompose temperature fluctuations using **Fourier transform**
- The former approaches the latter in the small-angle limit

$$\hat{n} = (\sin \theta \cos \phi, \sin \theta \sin \phi, \cos \theta)$$

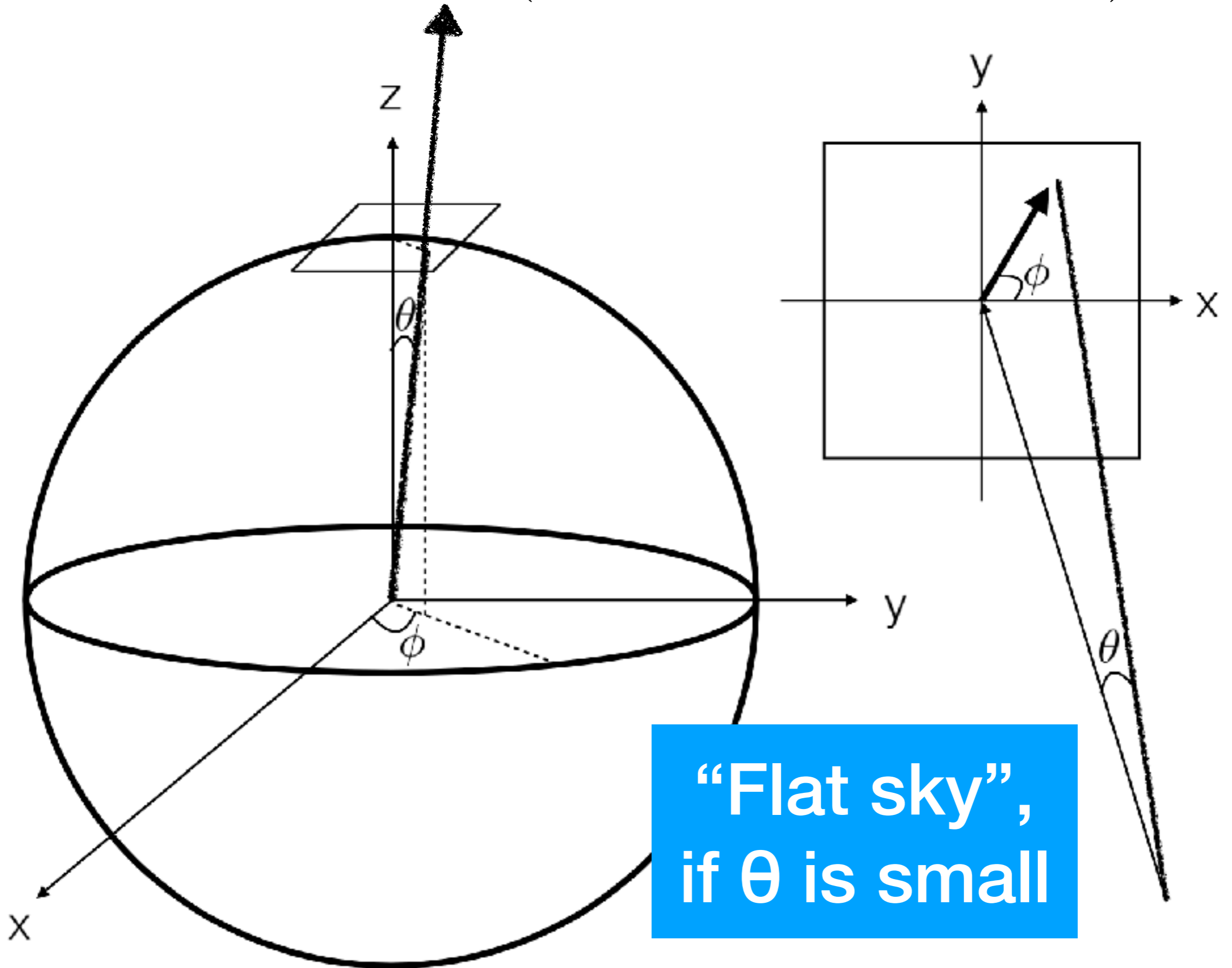



# 2d Fourier Transform

$$\begin{aligned}\Delta T(\hat{n}) &= \int \frac{d^2\ell}{(2\pi)^2} a_\ell \exp(i\ell \cdot \theta) \\ &= \int_0^\infty \frac{\ell d\ell}{2\pi} \int_0^{2\pi} \frac{d\phi_\ell}{2\pi} a_\ell \exp(i\ell \cdot \theta)\end{aligned}$$

**C.f.,**

$$\left( \Delta T(\hat{n}) = \sum_{\ell=1}^{\infty} \sum_{m=-\ell}^{\ell} a_{\ell m} Y_\ell^m(\hat{n}) \right)$$

# a(l) of the SW effect

- Using the inverse 2d Fourier transform on the Sachs-Wolfe (SW) formula

$$\frac{\Delta T(\hat{n})}{T_0} = \frac{1}{3} \Phi(t_L, \hat{r}_L)$$

and Fourier-transforming the potential, we obtain:

$$a_{\ell}^{\text{SW}} = \frac{T_0}{3} \int d^2\theta \exp(-i\boldsymbol{\ell} \cdot \boldsymbol{\theta}) \times \int \frac{d^3q}{(2\pi)^3} \Phi_{\mathbf{q}} \exp(i\mathbf{q}_{\perp} r_L \cdot \boldsymbol{\theta} + iq_{\parallel} r_L \cos \theta)$$

→ 1  
flat-sky approx.

# Flat-sky Result

$$a_{\ell}^{\text{SW}} = \frac{T_0}{3r_L^2} \int_{-\infty}^{\infty} \frac{dq_{\parallel}}{2\pi} \Phi_{\mathbf{q}} \left( \mathbf{q}_{\perp} = \frac{\ell}{r_L}, q_{\parallel} \right) \exp(iq_{\parallel}r_L)$$

$$q = \sqrt{\ell^2/r_L^2 + q_{\parallel}^2} \quad \text{i.e., } q \geq \ell/r_L$$

**C.f.,**

$$\left( a_{\ell m}^{\text{SW}} = \frac{4\pi T_0 i^{\ell}}{3} \int \frac{d^3 q}{(2\pi)^3} \Phi_{\mathbf{q}} j_{\ell}(qr_L) Y_{\ell}^{m*}(\hat{\mathbf{q}}) \right)$$

- It is **now manifest** that only the perpendicular wavenumber contributes to  $l$ , i.e.,  $l = q_{\text{perp}} r_L$ , giving  $l < q r_L$

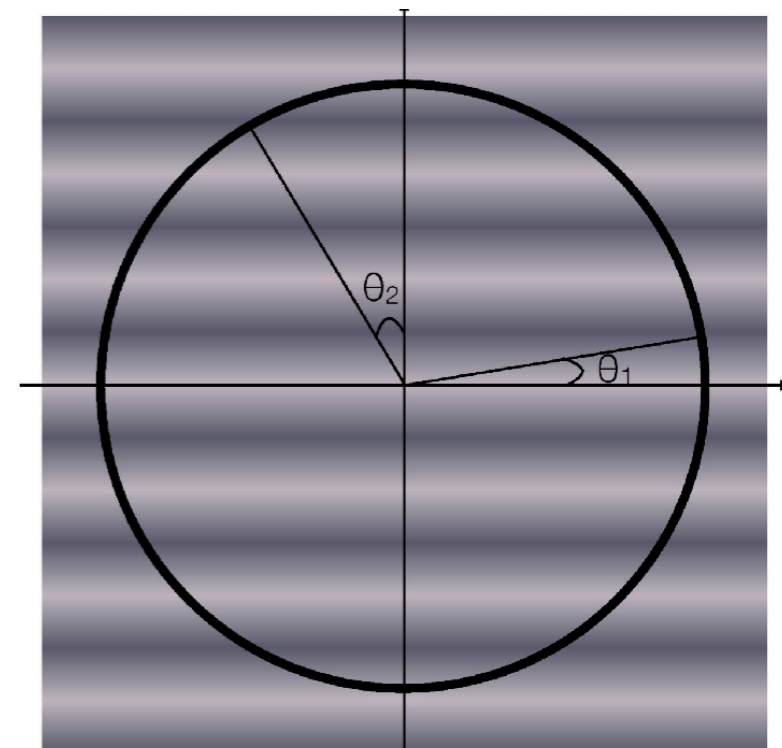

# Angular Power Spectrum

- The angular power spectrum,  $C_l$ , quantifies how much correlation power we have at a given angular separation.

$$C_l \equiv \frac{1}{2l+1} \sum_{m=-l}^l a_{lm} a_{lm}^*$$

- More precisely: it is  **$l(2l+1)C_l/4\pi$**  that gives the fluctuation power at a given angular separation,  $\sim\pi/l$ . We can see this by computing **variance**:

$$\int \frac{d\Omega}{4\pi} \Delta T^2(\hat{n}) = \frac{1}{4\pi} \sum_{l=2}^{\infty} \sum_{m=-l}^l a_{lm} a_{lm}^* = \sum_{l=2}^{\infty} \frac{2l+1}{4\pi} C_l$$



# COBE 4-year Power Spectrum

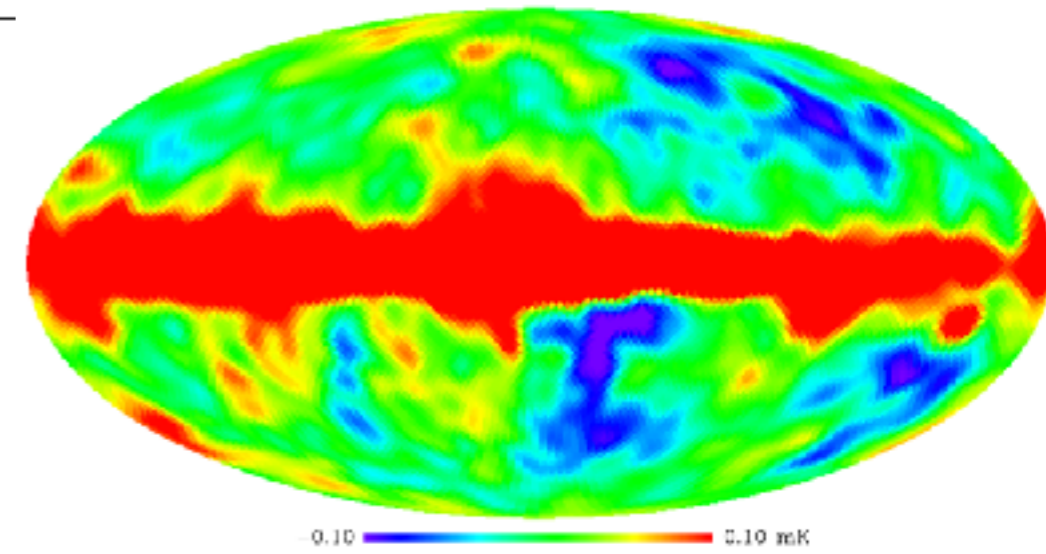
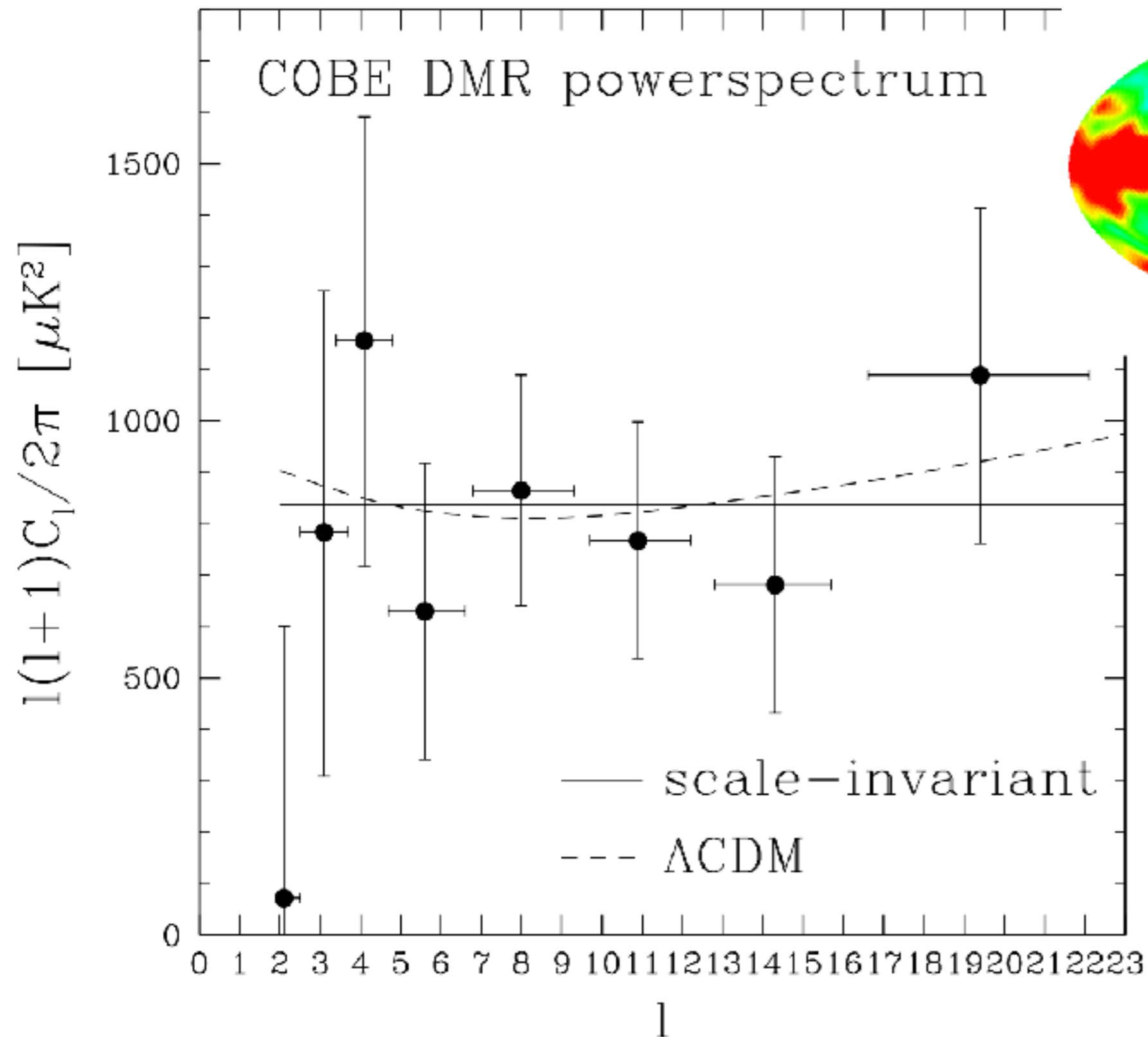

The SW formula allows us to determine the **3d power spectrum of  $\phi$**  at the last scattering surface from  $C_l$ .

**But how?**

# SW Power Spectrum

$$a_{\ell m}^{\text{SW}} = \frac{4\pi T_0 i^\ell}{3} \int \frac{d^3 q}{(2\pi)^3} \Phi_{\mathbf{q}} j_\ell(q r_L) Y_\ell^{m*}(\hat{\mathbf{q}})$$

$$C_\ell \equiv \frac{1}{2\ell + 1} \sum_{m=-\ell}^{\ell} a_{\ell m} a_{\ell m}^*$$

**gives...**

$$C_{\ell, \text{SW}} = \frac{4\pi T_0^2}{9} \int \frac{d^3 q}{(2\pi)^3} \int \frac{d^3 q'}{(2\pi)^3} \Phi_{\mathbf{q}} \Phi_{\mathbf{q}'}^* j_\ell(q r_L) j_\ell(q' r_L) P_\ell(\hat{\mathbf{q}} \cdot \hat{\mathbf{q}'})$$

- But this is not exactly what we want. We want the **statistical average** of this quantity.

# Power Spectrum of $\phi$

- Statistical average of the right hand side contains

$$\langle \Phi_{\mathbf{q}} \Phi_{\mathbf{q}'}^* \rangle = \int d^3x \int d^3r \langle \Phi(\mathbf{x}) \Phi(\mathbf{x} + \mathbf{r}) \rangle \exp [i(\mathbf{q} - \mathbf{q}') \cdot \mathbf{x} - i\mathbf{q}' \cdot \mathbf{r}]$$

**two-point correlation function**

**If  $\langle \Phi(\mathbf{x}) \Phi(\mathbf{x} + \mathbf{r}) \rangle$  does not depend on locations ( $\mathbf{x}$ ) but only on separations between two points ( $\mathbf{r}$ ), then**

$$\langle \Phi_{\mathbf{q}} \Phi_{\mathbf{q}'}^* \rangle = (2\pi)^3 \delta_D^{(3)}(\mathbf{q} - \mathbf{q}') \int d^3r \xi_{\phi}(\mathbf{r}) \exp(-i\mathbf{q} \cdot \mathbf{r})$$

**consequence of “statistical homogeneity”**

where we defined  $\xi_{\phi}(\mathbf{r}) \equiv \langle \Phi(\mathbf{x}) \Phi(\mathbf{x} + \mathbf{r}) \rangle$

and used  $\int d^3x \exp(i\mathbf{q} \cdot \mathbf{x}) = (2\pi)^3 \delta_D^{(3)}(\mathbf{q})$

# Power Spectrum of $\phi$

- In addition, if  $\xi_\phi(\mathbf{r}) \equiv \langle \Phi(\mathbf{x})\Phi(\mathbf{x} + \mathbf{r}) \rangle$  depends only on the magnitude of the separation  $r$  and not on the directions, then

$$\langle \Phi_{\mathbf{q}}\Phi_{\mathbf{q}'}^* \rangle = (2\pi)^3 \delta_D^{(3)}(\mathbf{q} - \mathbf{q}') \int 4\pi r^2 dr \xi_\phi(r) \frac{\sin(qr)}{qr}$$

$$= (2\pi)^3 \delta_D^{(3)}(\mathbf{q} - \mathbf{q}') P_\phi(q)$$

**Power spectrum!**

Generic definition of the power spectrum for statistically homogeneous and isotropic fluctuations



# SW Power Spectrum

- Thus, the power spectrum of the CMB in the SW limit is

$$\langle C_{\ell, \text{SW}} \rangle = \frac{16\pi^2 T_0^2}{9} \int_0^\infty \frac{q^2 dq}{(2\pi)^3} P_\phi(q) j_\ell^2(qr_L)$$

- In the flat-sky approximation,

$$\langle C_{\ell, \text{SW}} \rangle = \frac{T_0^2}{9r_L^2} \int_{-\infty}^\infty \frac{dq_{\parallel}}{2\pi} P_\phi \left( \sqrt{\frac{\ell^2}{r_L^2} + q_{\parallel}^2} \right)$$

# SW Power Spectrum

- Thus, the power spectrum of the CMB in the SW limit is

$$\langle C_{\ell, \text{SW}} \rangle = \frac{16\pi^2 T_0^2}{9} \int_0^\infty \frac{q^2 dq}{(2\pi)^3} P_\phi(q) j_\ell^2(qr_L)$$

- In the flat-sky approximation,

$$\langle C_{\ell, \text{SW}} \rangle = \frac{T_0^2}{9r_L^2} \int_{-\infty}^\infty \frac{dq_{\parallel}}{2\pi} P_\phi \left( \sqrt{\frac{\ell^2}{r_L^2} + q_{\parallel}^2} \right)$$

For a power-law form,  $P_\phi(q) = (2\pi)^3 N_\phi^2 q^{n-4}$ , we get

$$\langle C_{\ell, \text{SW}} \rangle = \frac{8\pi^2 N_\phi^2 T_0^2}{9\ell^2} \left( \frac{\ell}{r_L} \right)^{n-1} \frac{\sqrt{\pi} \Gamma[(3-n)/2]}{2 \Gamma[(4-n)/2]}$$

# SW Power Spectrum

- Thus, the power spectrum of the CMB in the SW limit is

$$\langle C_{\ell, \text{SW}} \rangle = \frac{16\pi^2 T_0^2}{9} \int_0^\infty \frac{q^2 dq}{(2\pi)^3} P_\phi(q) j_\ell^2(qr_L)$$

- In the flat-sky approximation,

$$\langle C_{\ell, \text{SW}} \rangle = \frac{T_0^2}{9r_L^2} \int_{-\infty}^\infty \frac{dq_{\parallel}}{2\pi} P_\phi \left( \sqrt{\frac{\ell^2}{r_L^2} + q_{\parallel}^2} \right)$$

For a power-law form,  $P_\phi(q) = (2\pi)^3 N_\phi^2 q^{n-4}$ , we get

$$\langle C_{\ell, \text{SW}} \rangle = \frac{8\pi^2 N_\phi^2 T_0^2}{9\ell^2} \left( \frac{\ell}{r_L} \right)^{n-1} \frac{\sqrt{\pi} \Gamma[(3-n)/2]}{2 \Gamma[(4-n)/2]} \xrightarrow{n=1} \frac{8\pi^2 N_\phi^2 T_0^2}{9\ell(\ell+1)}$$

full-sky correction

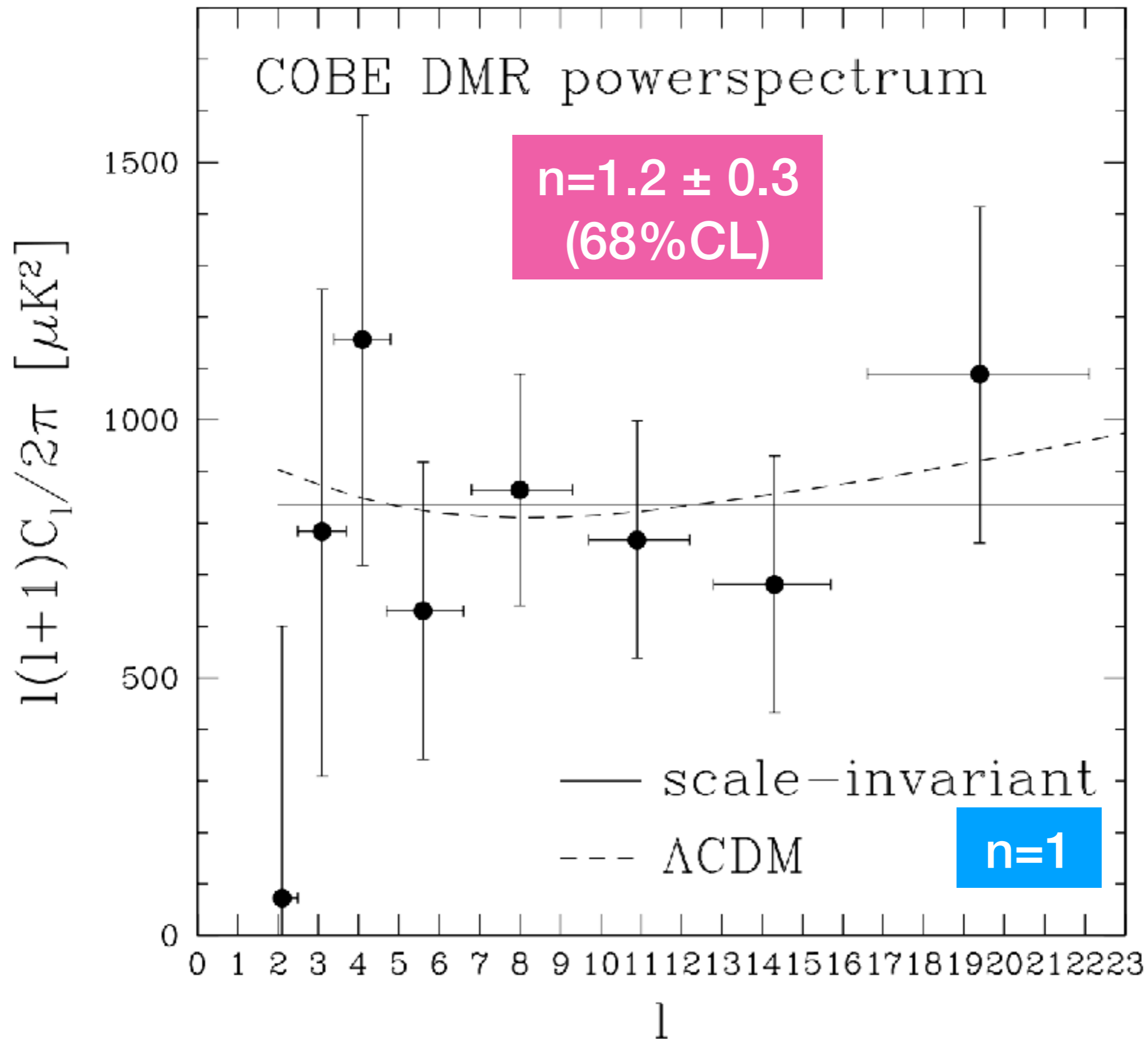



# COBE 4-year Power Spectrum

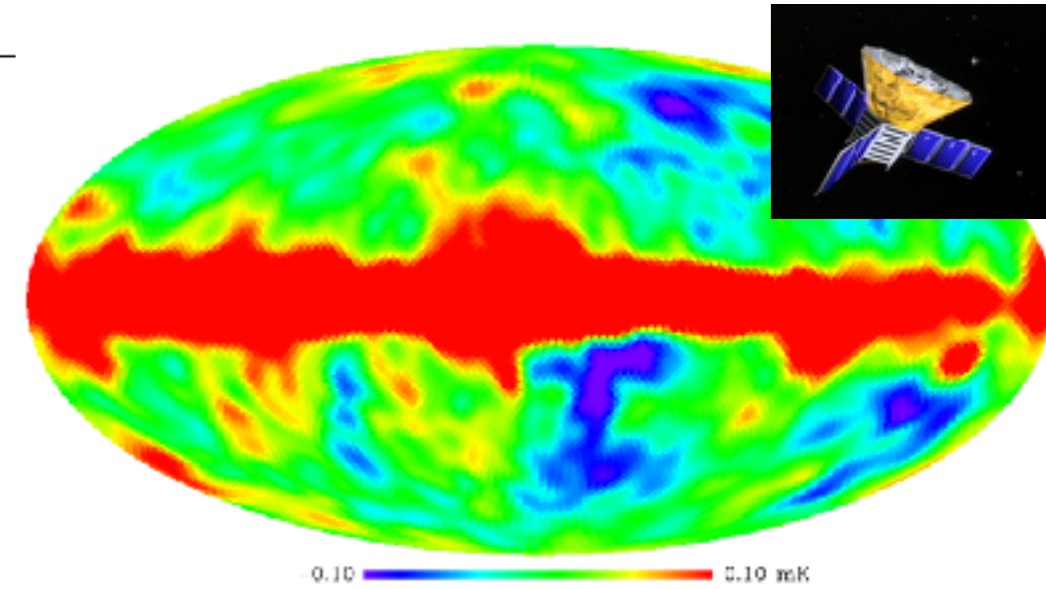
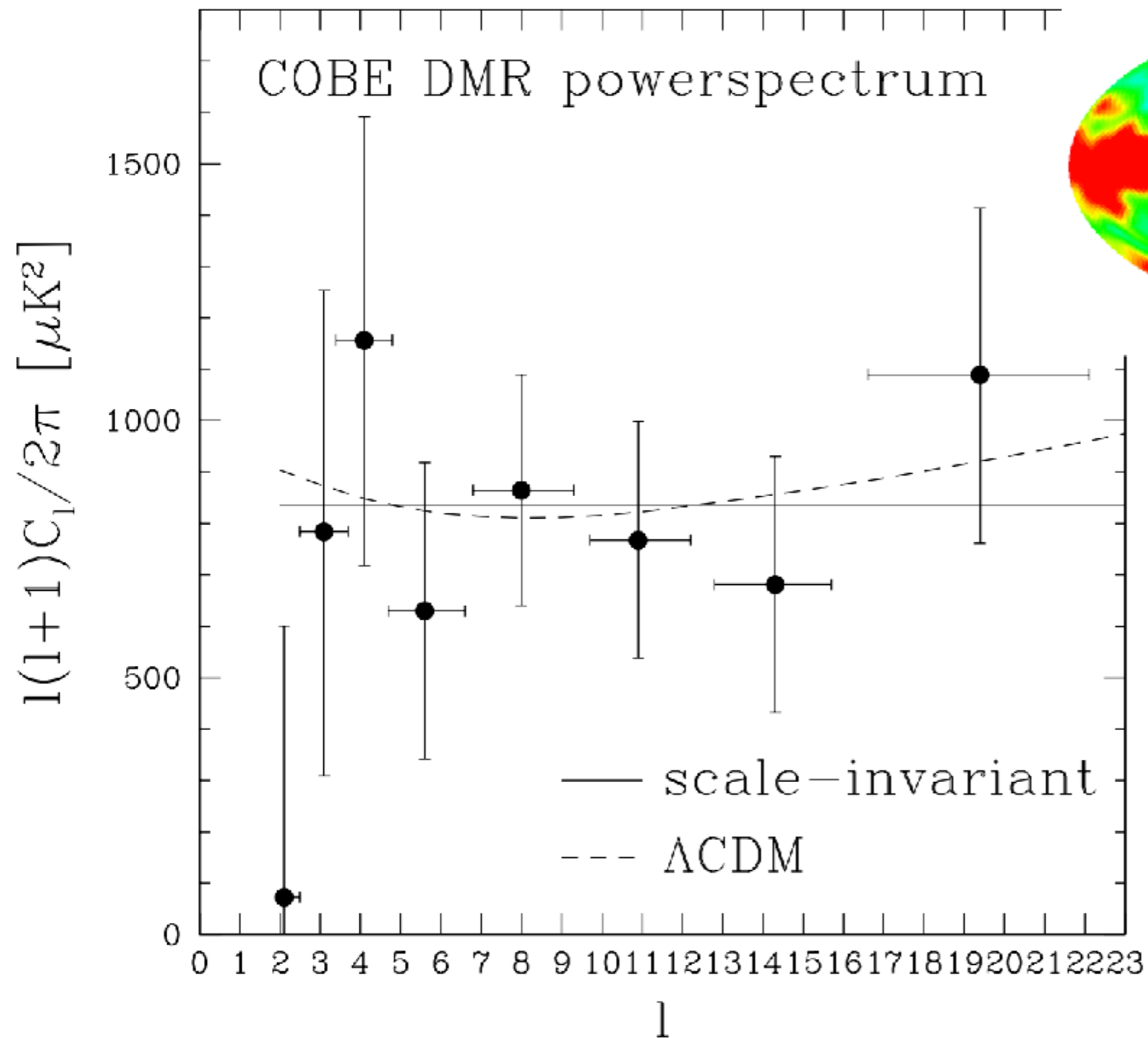

# WMAP 9-year Power Spectrum

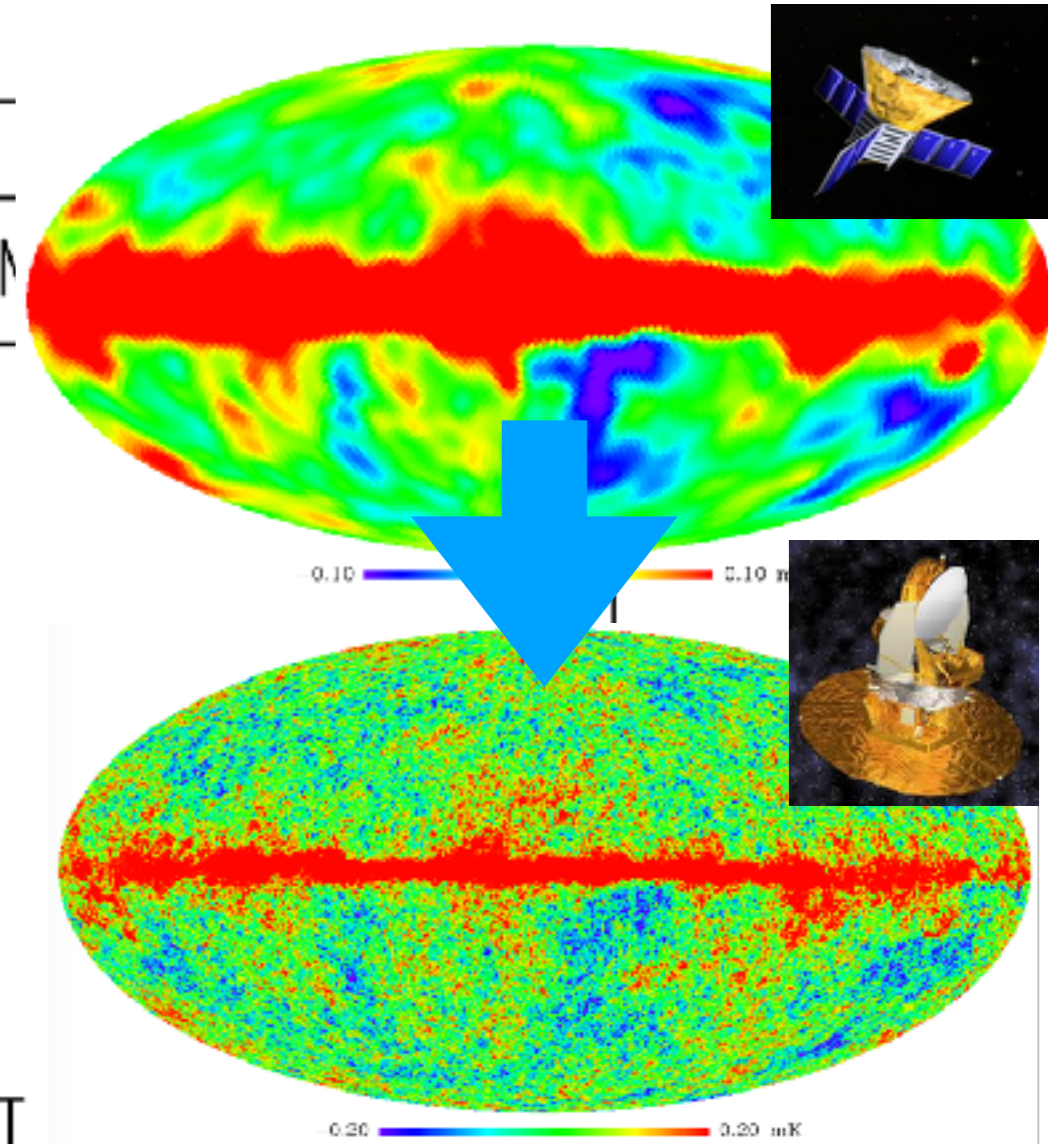
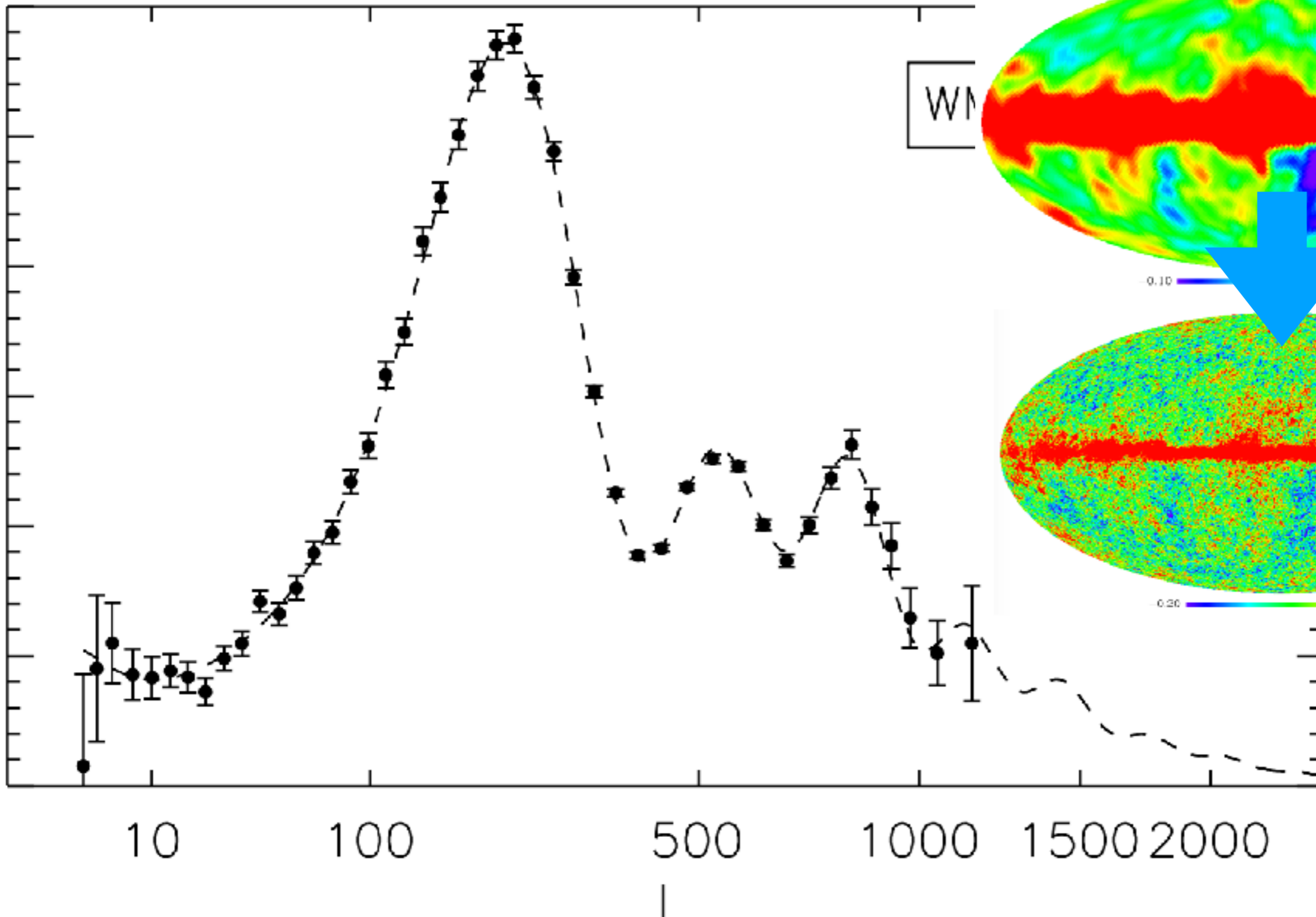

# Planck 29-mo Power Spectrum

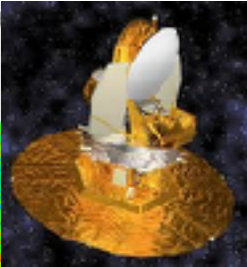
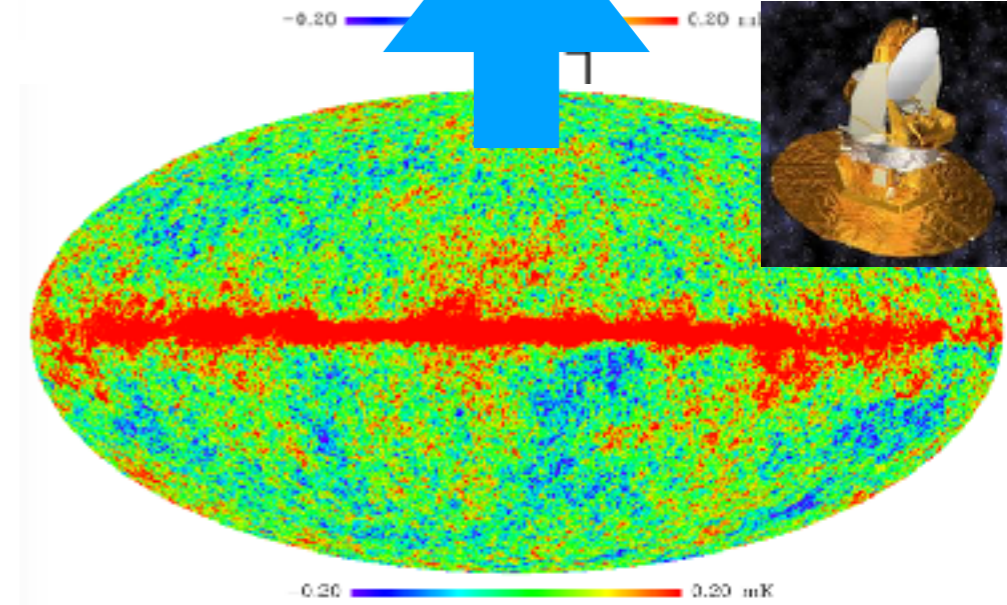
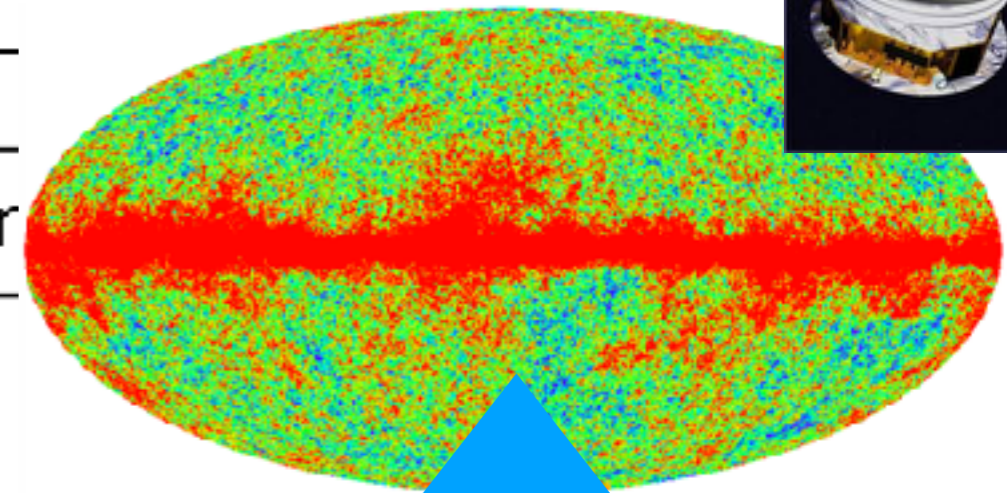
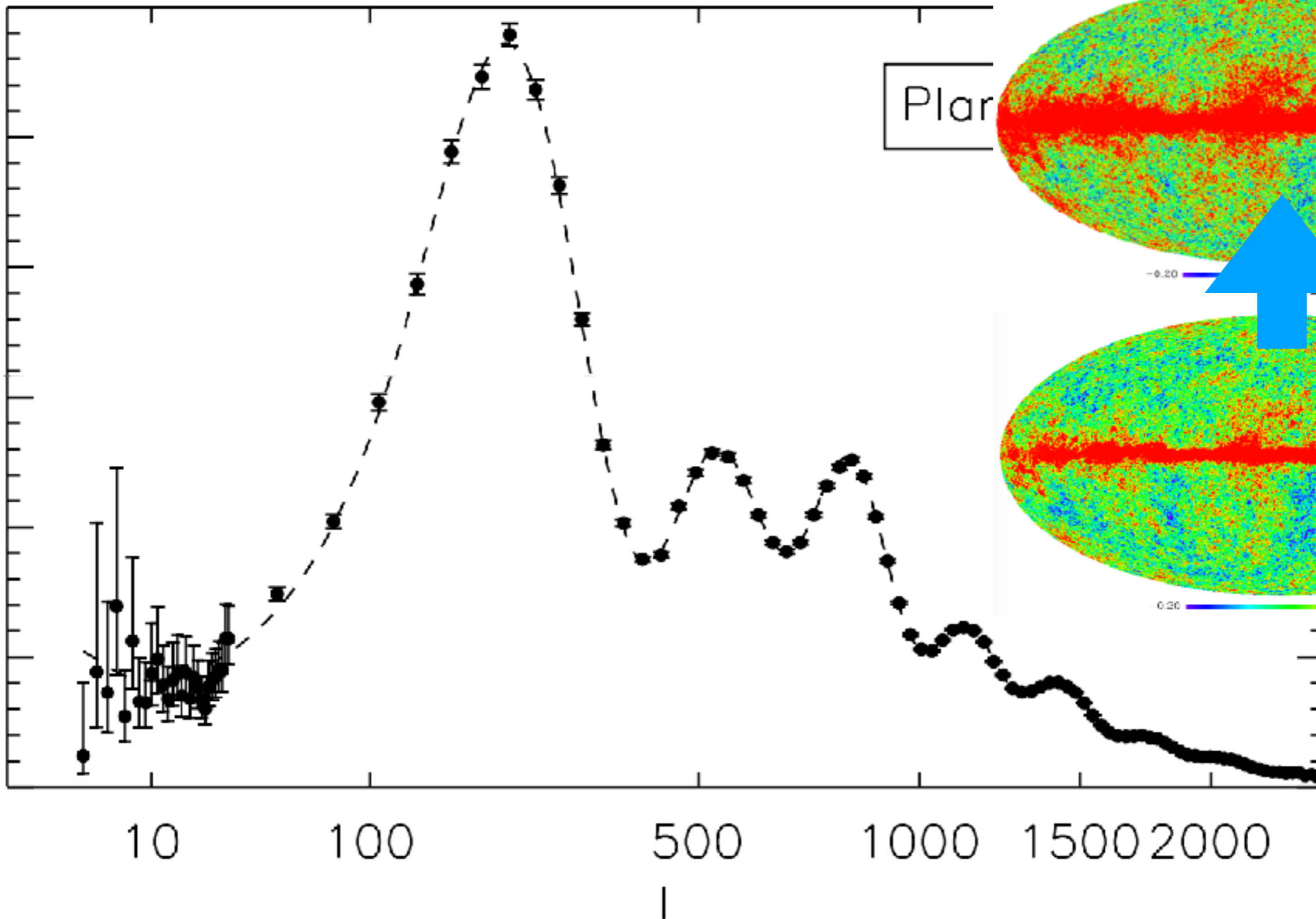
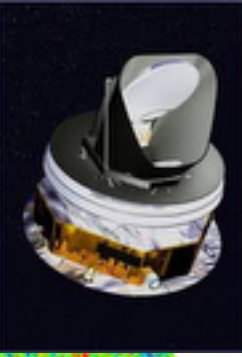



# Planck 29-mo Power Spectrum

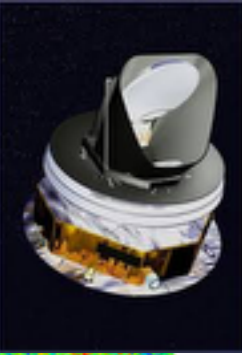

Clearly, the SW prediction does not fit!

$$\langle C_{\ell, SW} \rangle = \frac{8\pi^2 N_{\phi}^2 T_0^2}{9\ell^2} \left( \frac{\ell}{r_L} \right)^{n-1} \frac{\sqrt{\pi} \Gamma[(3-n)/2]}{2 \Gamma[(4-n)/2]}$$

Missing physics:  
Hydrodynamics  
(sound waves)

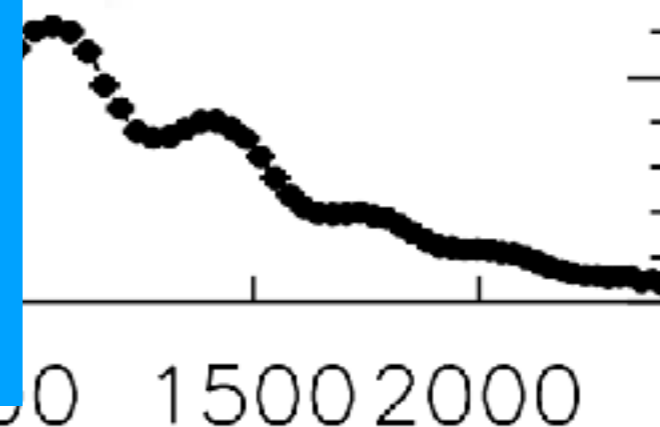
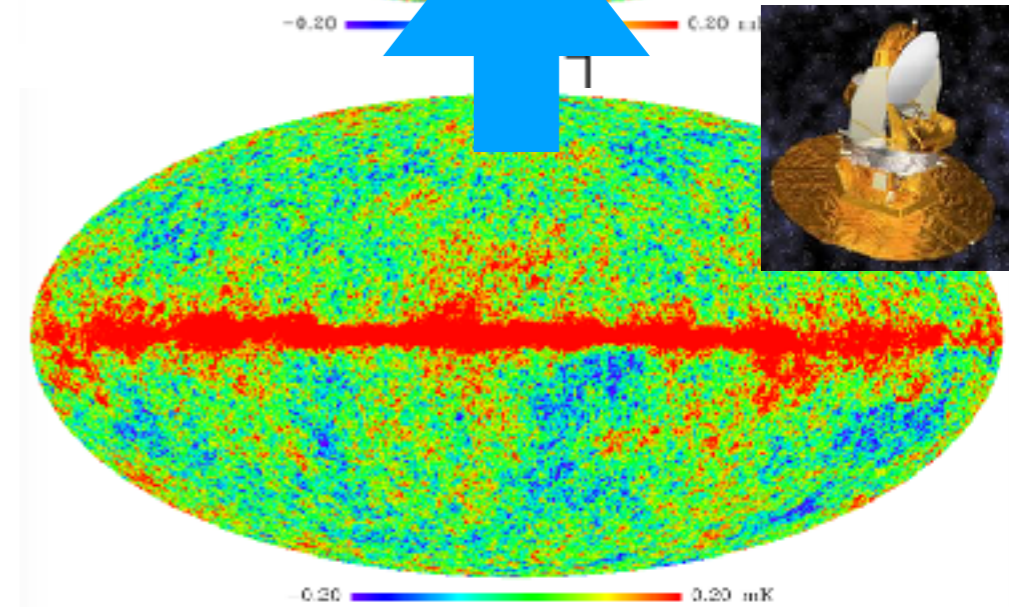
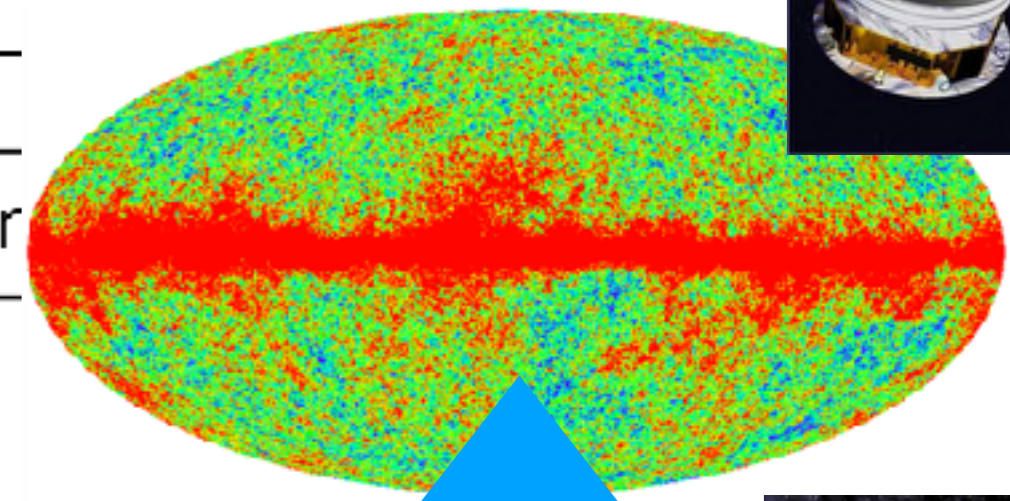







A close-up photograph of a red ceramic bowl filled with a light-colored, creamy miso soup. Several pieces of chopped green onions are scattered on top of the soup. A white ceramic spoon is partially visible on the left side of the bowl. The bowl is placed on a light-colored, textured surface.

Tomorrow [9:15–10:30]

- Temperature anisotropy from hydrodynamical effects (sound waves)