

Searches for Long Lived Particles at the LHC – Present and Future

Albert De Roeck
CERN, Geneva, Switzerland
Antwerp University Belgium
UC-Davis California USA
NTU, Singapore

30th May 2019



The Abdus Salam
International Centre
for Theoretical Physics



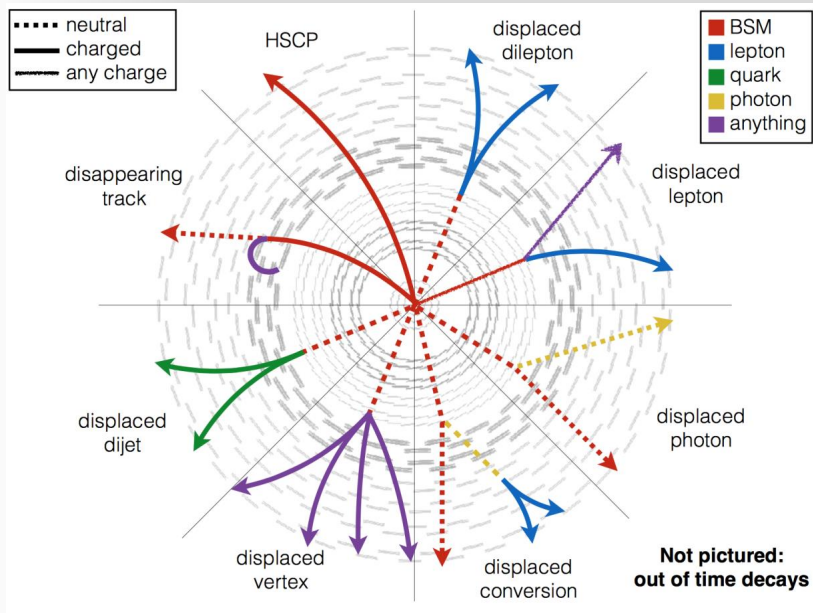

Outline

- Introduction to long lived exotic particles: why do we care?
- Challenges at and a few results from the LHC
- New experiments for the LHC?
- Other opportunities for LLPs searches
- Summary/Outlook

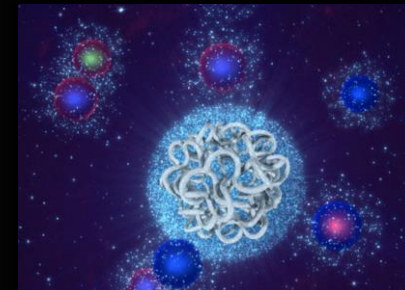
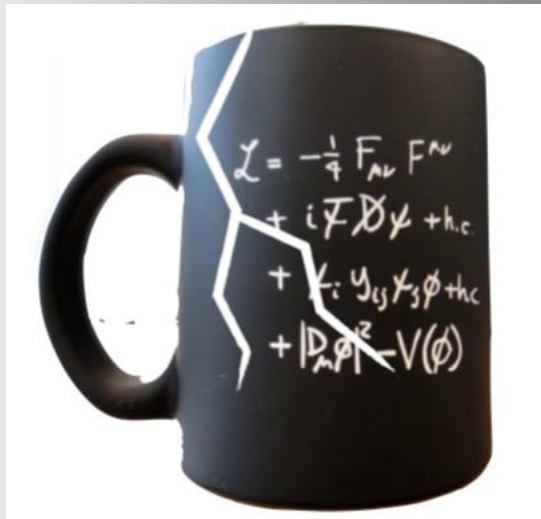

New Physics Hunters @ the LHC

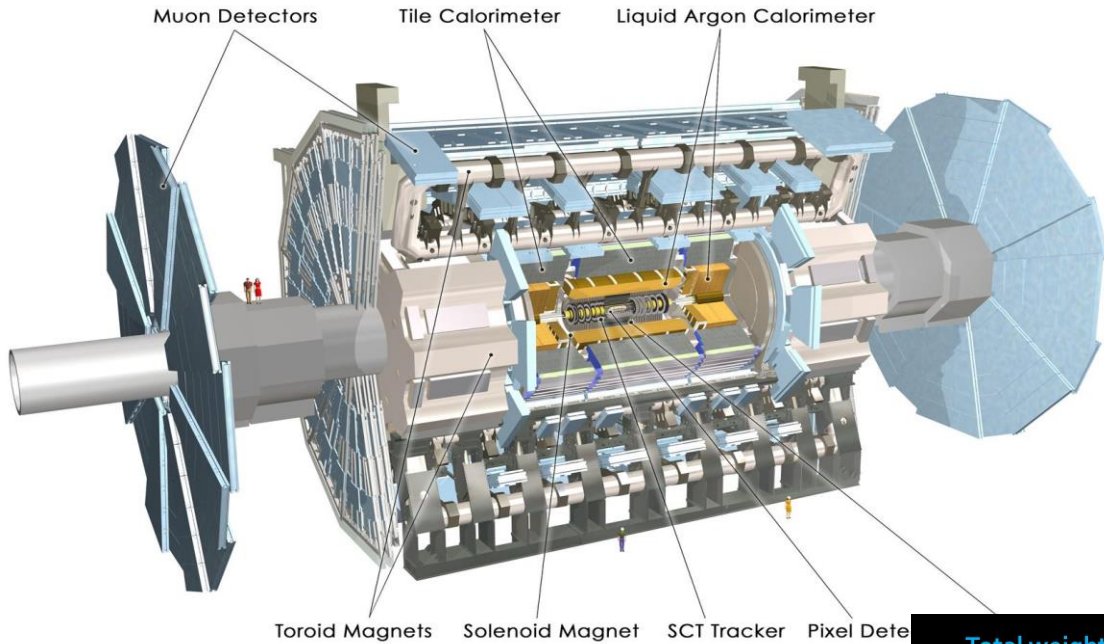

The ATLAS experiment

The CMS experiment

...And also LHCb and MoEDAL

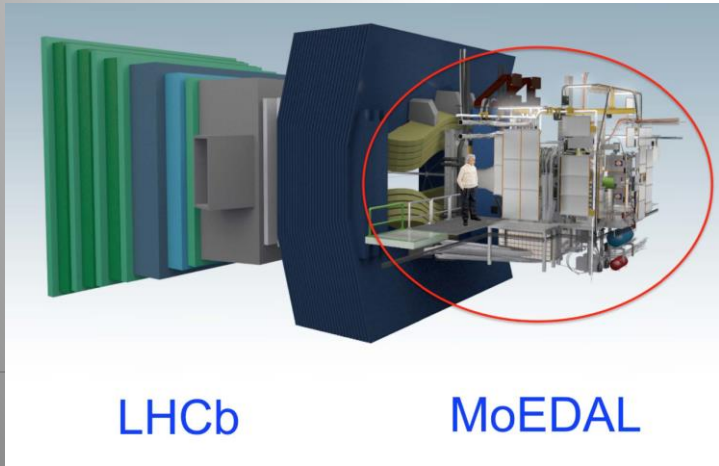

CMS

Total weight 14000 t
Overall diameter 15 m
Overall length 28.7 m

ECAL 76k scintillating PbWO₄ crystals
HCAL Scintillator/brass Interleaved ~7k ch
3.8T Solenoid
IRON YOKE
MUON ENDCAPS 473 Cathode Strip Chambers (CSC) 432 Resistive Plate Chambers (RPC)
Preshower Si Strips ~16 m² ~137k ch
Forward Cal Steel + quartz Fibers 2~k ch
MUON BARREL 250 Drift Tubes (DT) and 480 Resistive Plate Chambers (RPC)

Pixel Tracker
ECAL
HCAL
Muons
Solenoid coil

YB0
YB1-2
YET-3

Pixels & Tracker
 • Pixels (100x150 μm²) ~ 1 m² ~66M ch
 • Si Strips (80-180 μm) ~200 m² ~9.6M ch

LHC: So far no new physics

ATLAS SUSY Searches* - 95% CL Lower Limits

March 2019

Model	Signature	$\int \mathcal{L} dt$ [fb $^{-1}$]	Mass limit	Reference							
Inclusive Searches	$\tilde{q}\tilde{q}, \tilde{q} \rightarrow q\tilde{q}^0$	0 e, μ mono-jet	2-6 jets 1-3 jets	$E_{T,miss}^{min}$ $E_{T,miss}^{min}$	36.1 36.1	\tilde{q} [Xk, Bk Degen] \tilde{q} [Xk, Bk Degen]	0.43 0.71	0.9 1.55	$m(\tilde{q}^0)=100$ GeV $m(\tilde{q})=m(\tilde{q}^0)+5$ GeV	1712.02332 1711.03301	
	$\tilde{b}\tilde{b}, \tilde{b} \rightarrow q\tilde{q}^0$	0 e, μ	2-6 jets	$E_{T,miss}^{min}$	36.1	\tilde{b}	Forbidden	0.95-1.6 2.0	$m(\tilde{q}^0)=200$ GeV $m(\tilde{q}^0)=300$ GeV	1712.02332 1712.02332	
	$\tilde{b}\tilde{b}, \tilde{b} \rightarrow q\tilde{q}^0 t\tilde{t}^0$	3 e, μ e, μ, μ	4 jets 2 jets	$E_{T,miss}^{min}$ $E_{T,miss}^{min}$	36.1 36.1	\tilde{b}	Forbidden	1.2 1.85	$m(\tilde{q}^0)=300$ GeV $m(\tilde{q}^0)=250$ GeV	1706.03731 1605.11381	
	$\tilde{b}\tilde{b}, \tilde{b} \rightarrow q\tilde{q}^0 WZ\tilde{q}^0$	0 e, μ 3 e, μ	7-11 jets 4 jets	$E_{T,miss}^{min}$ $E_{T,miss}^{min}$	36.1 36.1	\tilde{b}	Forbidden	0.98	1.6	$m(\tilde{q}^0)=400$ GeV $m(\tilde{q}^0)=200$ GeV	1708.02794 1706.03731
	$\tilde{b}\tilde{b}, \tilde{b} \rightarrow t\tilde{t}^0$	0-1 e, μ 3 e, μ	3 b 4 jets	$E_{T,miss}^{min}$ $E_{T,miss}^{min}$	79.8 36.1	\tilde{b}	Forbidden	1.25	2.25	$m(\tilde{q}^0)=200$ GeV $m(\tilde{q}^0)=300$ GeV	ATLAS-CONF-2018-041 1706.03731
3 ν non-staircase direct production	$\tilde{b}_1\tilde{b}_1, \tilde{b}_1 \rightarrow b\tilde{q}^0 t\tilde{q}^0$	Multiple	Multiple	$E_{T,miss}^{min}$	36.1	\tilde{b}_1	Forbidden	0.9	$m(\tilde{q}^0)=300$ GeV, $BR(\tilde{q}^0)=1$	1708.03066, 1711.03301	
	$\tilde{b}_1\tilde{b}_1, \tilde{b}_1 \rightarrow b\tilde{q}^0 t\tilde{q}^0$	Multiple	Multiple	$E_{T,miss}^{min}$	36.1	\tilde{b}_1	Forbidden	0.58-0.82	$m(\tilde{q}^0)=300$ GeV, $BR(\tilde{q}^0)=BR(\tilde{t}^0)=0.5$	1708.09266	
	$\tilde{b}_1\tilde{b}_1, \tilde{b}_1 \rightarrow b\tilde{q}^0 t\tilde{q}^0$	0 e, μ	6 b	$E_{T,miss}^{min}$	139	\tilde{b}_1	Forbidden	0.7	$m(\tilde{q}^0)=200$ GeV, $m(\tilde{q}^0)=300$ GeV, $BR(\tilde{q}^0)=1$	1706.03731	
	$\tilde{b}_1\tilde{b}_1, \tilde{b}_1 \rightarrow b\tilde{q}^0 t\tilde{q}^0$	0 e, μ	6 b	$E_{T,miss}^{min}$	139	\tilde{b}_1	Forbidden	0.23-0.48	$\Delta m(\tilde{q}^0, \tilde{q}^0)=130$ GeV, $m(\tilde{q}^0)=100$ GeV $\Delta m(\tilde{q}^0, \tilde{q}^0)=130$ GeV, $m(\tilde{q}^0)=0$ GeV	SUSY-2018-31 SUSY-2018-31	
	$\tilde{b}_1\tilde{b}_1, \tilde{b}_1 \rightarrow W\tilde{q}^0 t\tilde{q}^0$ or $\tilde{t}\tilde{t}^0$	0-2 e, μ	0-2 jets/1-2 b	$E_{T,miss}^{min}$	36.1	\tilde{b}_1	Forbidden	1.0	$m(\tilde{q}^0)=1$ GeV	1506.08816, 1709.04183, 1711.11520	
EW direct	$\tilde{t}_1\tilde{t}_1, \tilde{t}_1 \rightarrow W\tilde{q}^0 t\tilde{q}^0$ or $\tilde{t}\tilde{t}^0$	Multiple	Multiple	$E_{T,miss}^{min}$	36.1	\tilde{t}_1	Forbidden	0.48-0.64	$m(\tilde{q}^0)=150$ GeV, $m(\tilde{q}^0)=m(\tilde{q}^0)+5$ GeV, $f_b \neq f_t$	1709.04183, 1711.11520	
	$\tilde{t}_1\tilde{t}_1, \tilde{t}_1 \rightarrow \tau\tilde{q}^0 t\tilde{q}^0$	1 $\tau + 1 e, \mu, \tau$	2 jets/1 b	$E_{T,miss}^{min}$	36.1	\tilde{t}_1	Forbidden	1.16	$m(\tilde{q}^0)=300$ GeV	1603.10178	
	$\tilde{t}_1\tilde{t}_1, \tilde{t}_1 \rightarrow \tau\tilde{q}^0 t\tilde{q}^0$	0 e, μ	2 c	$E_{T,miss}^{min}$	36.1	\tilde{t}_1	Forbidden	0.85	$m(\tilde{q}^0)=0$ GeV	1605.01649	
	$\tilde{t}_1\tilde{t}_1, \tilde{t}_1 \rightarrow \tau\tilde{q}^0 t\tilde{q}^0$	0 e, μ	mono-jet	$E_{T,miss}^{min}$	36.1	\tilde{t}_1	Forbidden	0.46 0.43	$m(\tilde{q}^0)=m(\tilde{q}^0)+50$ GeV	1605.01649 1711.03301	
	$\tilde{t}_1\tilde{t}_1, \tilde{t}_1 \rightarrow h$	1-2 e, μ	4 b	$E_{T,miss}^{min}$	36.1	\tilde{t}_1	Forbidden	0.32-0.88	$m(\tilde{q}^0)=0$ GeV, $m(\tilde{q}^0)=m(\tilde{q}^0)+180$ GeV	1706.03986	
Long-lived particles	$\tilde{t}_1\tilde{t}_1^0$ via WZ	2-3 e, μ e, μ, μ	≥ 1	$E_{T,miss}^{min}$ $E_{T,miss}^{min}$	36.1 36.1	\tilde{t}_1 \tilde{t}_1	Forbidden	0.17	$m(\tilde{q}^0)=0$ $m(\tilde{q}^0)=m(\tilde{q}^0)+10$ GeV	1403.5394, 1606.02293 1712.08119	
	$\tilde{t}_1\tilde{t}_1^0$ via WW	2 e, μ	139	$E_{T,miss}^{min}$	36.1	\tilde{t}_1	Forbidden	0.42	$m(\tilde{q}^0)=0$ GeV	ATLAS-CONF-2019-008	
	$\tilde{t}_1\tilde{t}_1^0$ via Wb	0-1 e, μ	2 b	$E_{T,miss}^{min}$	36.1	\tilde{t}_1	Forbidden	0.68	$m(\tilde{q}^0)=0$ GeV	1812.09432	
	$\tilde{t}_1\tilde{t}_1^0$ via $\tilde{t}\tilde{t}^0$	2 e, μ	139	$E_{T,miss}^{min}$	36.1	\tilde{t}_1	Forbidden	1.0	$m(\tilde{q}^0)=0$ GeV	ATLAS-CONF-2019-008	
	$\tilde{t}_1\tilde{t}_1^0, \tilde{t}_1\tilde{t}_1^0, \tilde{t}_1\tilde{t}_1^0 \rightarrow \tau\tilde{t}^0 t\tilde{t}^0, \tilde{t}_1\tilde{t}_1^0 \rightarrow \tau\tilde{t}^0 t\tilde{t}^0$	2 τ	139	$E_{T,miss}^{min}$	36.1	\tilde{t}_1	Forbidden	0.22	$m(\tilde{q}^0)=0, m(\tilde{q}^0)=0.5m(\tilde{q}^0)+m(\tilde{q}^0)$ $m(\tilde{q}^0)=0, m(\tilde{q}^0)=0.5m(\tilde{q}^0)+m(\tilde{q}^0)$ $m(\tilde{q}^0)=100$ GeV, $m(\tilde{q}^0)=0.5m(\tilde{q}^0)+m(\tilde{q}^0)$	1708.07875 1708.07875	
RPV	$\tilde{t}_1\tilde{t}_1, \tilde{t}_1 \rightarrow h$	2 e, μ 2 e, μ	0 jets ≥ 1	$E_{T,miss}^{min}$ $E_{T,miss}^{min}$	139 36.1	\tilde{t}_1 \tilde{t}_1	Forbidden	0.18	$m(\tilde{q}^0)=0$ $m(\tilde{q}^0)=m(\tilde{q}^0)+5$ GeV	ATLAS-CONF-2019-008 1712.08119	
	$\tilde{t}_1\tilde{t}_1, \tilde{t}_1 \rightarrow h\tilde{q}^0 Z\tilde{q}^0$	0 e, μ 4 e, μ	≥ 3 b 0 jets	$E_{T,miss}^{min}$ $E_{T,miss}^{min}$	36.1 36.1	\tilde{t}_1 \tilde{t}_1	Forbidden	0.13-0.23 0.3	$BR(\tilde{q}^0) \rightarrow h\tilde{q}^0$ $BR(\tilde{q}^0) \rightarrow \tau\tilde{q}^0$	-----	
	Direct $\tilde{t}_1\tilde{t}_1, \tilde{t}_1$ prod., long-lived \tilde{t}_1^0	Disapp. trk	1 jet	$E_{T,miss}^{min}$	36.1	\tilde{t}_1	Forbidden	0.46	Pure \tilde{t}_1 Pure Higgs	-----	
	Stable \tilde{t}_1 R-hadron	Multiple	Multiple	$E_{T,miss}^{min}$	36.1	\tilde{t}_1	Forbidden	2.6	$m(\tilde{q}^0)=100$	-----	
	Metastable \tilde{t}_1 R-hadron, $\tilde{t}_1 \rightarrow q\tilde{q}^0 t\tilde{q}^0$	Multiple	Multiple	$E_{T,miss}^{min}$	36.1	\tilde{t}_1	Forbidden	2.05-2.4	$m(\tilde{q}^0)=100$	-----	

ATLAS Preliminary

$\sqrt{s} = 13$ TeV

Classical Searches
-Supersymmetry
-Exotica
-Flavor Universality
-...

13 TeV 8 TeV

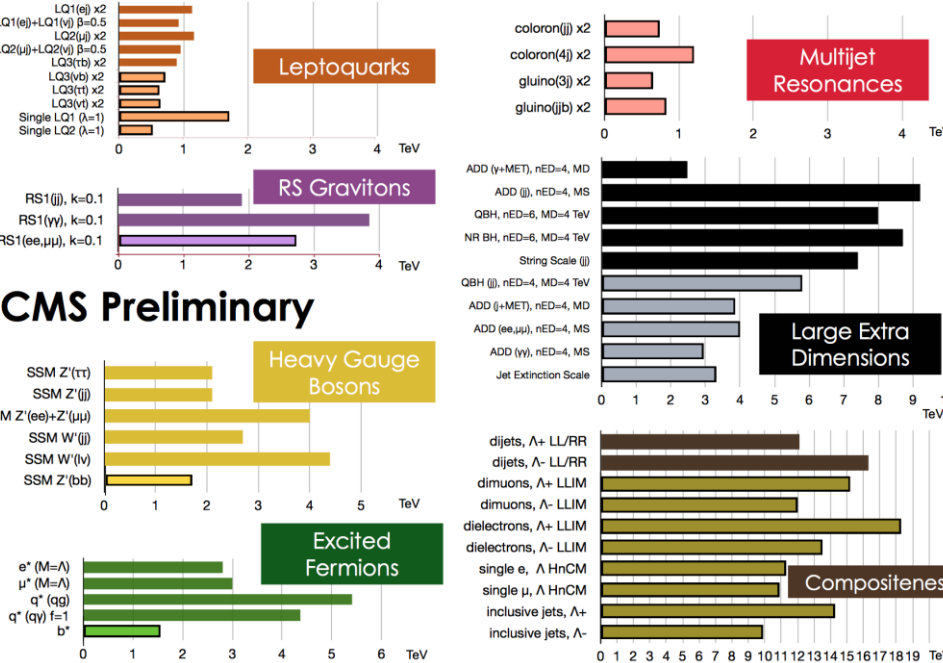

No signal of new physics so far!!

*Only a selection of the available mass limits on new states or phenomena is shown. Many of the limits are based on simplified models, c.f. refs. for the assumptions made.

Are we leaving no stone unturned?

- The LHC BSM searches are indispensable and should be continued in the new energy regime and with increasing statistics (higher mass, lower couplings)
- But if we still do not see more than a 2 sigma at the end of run 3, the HL-LHC will be likely mostly a precision physics machine, searching for subtle deviations or small couplings
- **Are we looking at the right place? Time for more effort in thinking of complementary searches?**

Are we looking at the right place?

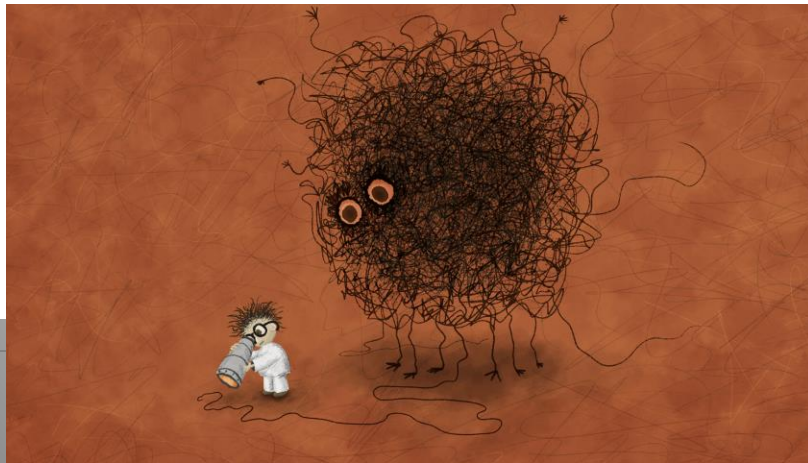

Leave no stone unturned!!



Long Lived Particles

Long lifetimes arise from a hierarchy of scales or a small coupling

- RP Violating SUSY
- ASMB SUSY
- Gauge Mediated SUSY
- Split SUSY
- Hidden Valleys Models
- Dark QED/Dark Photons
- **Monopoles**
- Quirk Models
- Dark Matter Models
- Stable Sexaquarks
- Axion-Like Particles
-

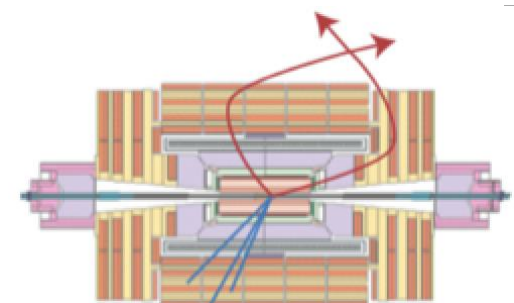
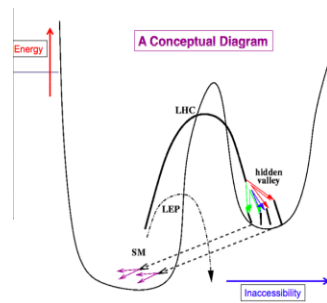
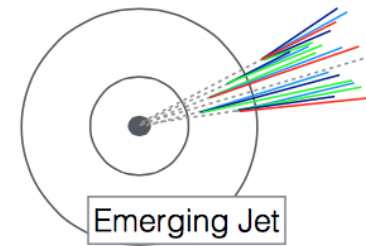
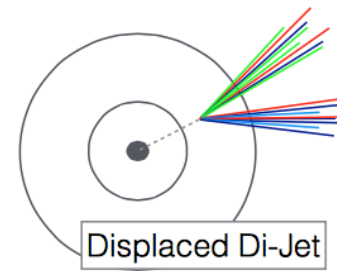
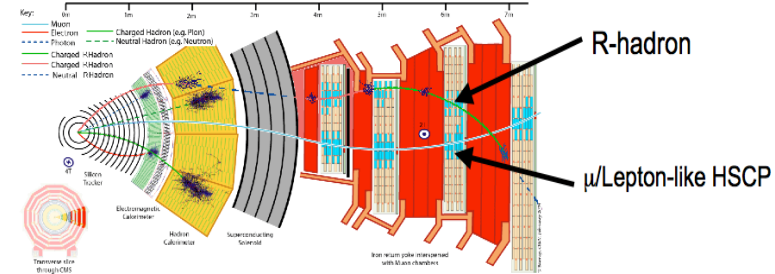
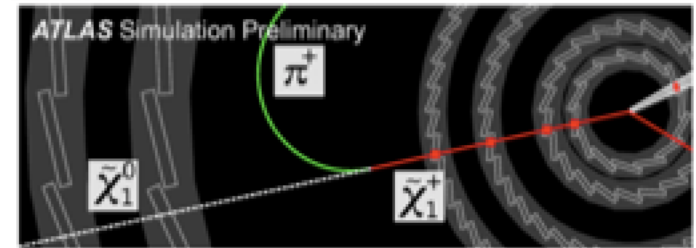

Long Lived Particles @LHC

Signatures

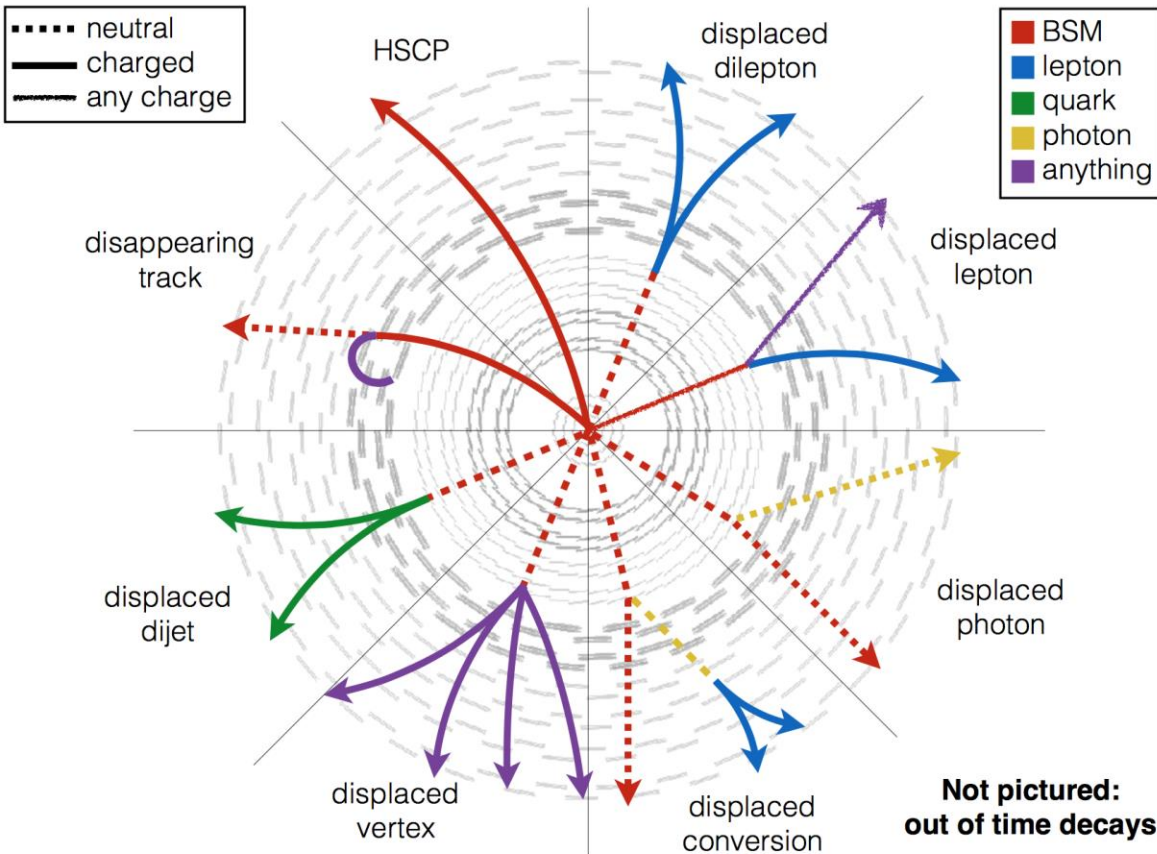

Some of the Challenges

Triggers: Tracking detectors are powerful but difficult to use in trigger

SM backgrounds often low. But need special studies (punch through, secondary interactions, tails, cosmoics...)

Special reconstruction is often needed

Some detector upgrades for High-Luminosity LHC (>2026) address these issues.

Long Lived Searches Overview

- Displaced jets, dijets, vertices
- Disappearing tracks
- Displaced leptons & lepton jets
- Displaced photons
- Dark photon decays
- Heavy Stable Charged Particles
- Stopped particles
- Emerging jets
- Monopoles stuck in material
- Heavy Neutral Lepton searches
- Strongly Interaction Massive Particles
- (others...new ideas...)

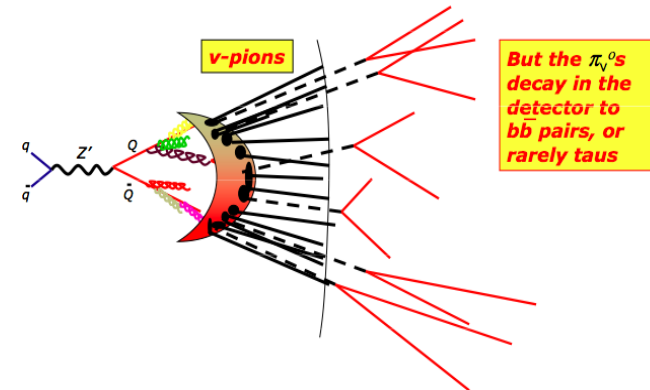
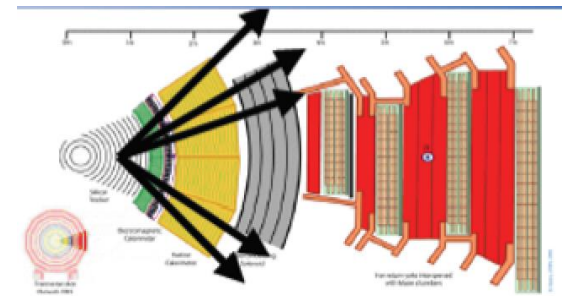
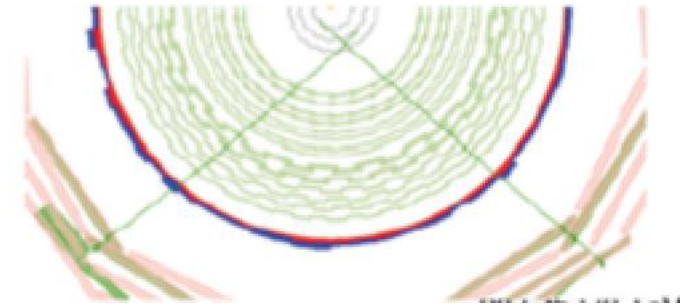

Long Lived Searches: Examples

displaced jets

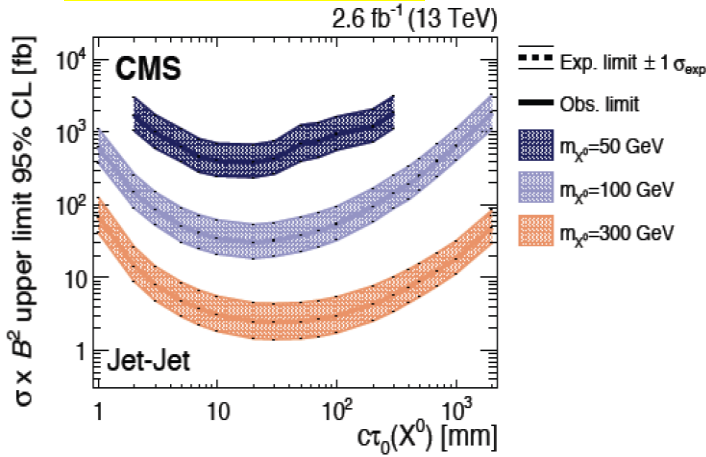

displaced leptons

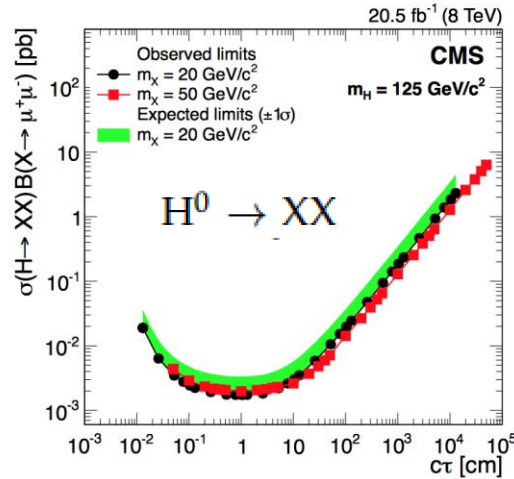

disappearing tracks

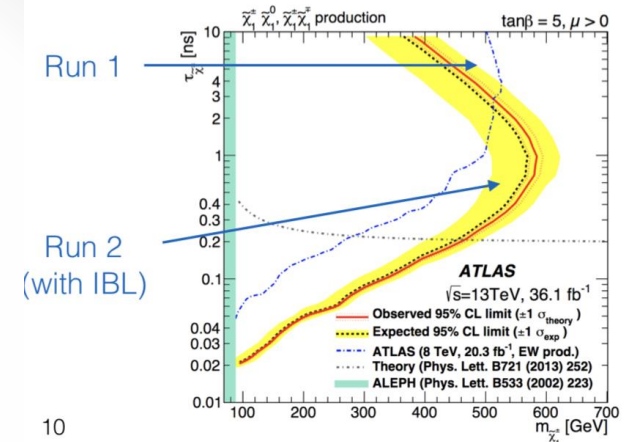

metastable R-hadrons

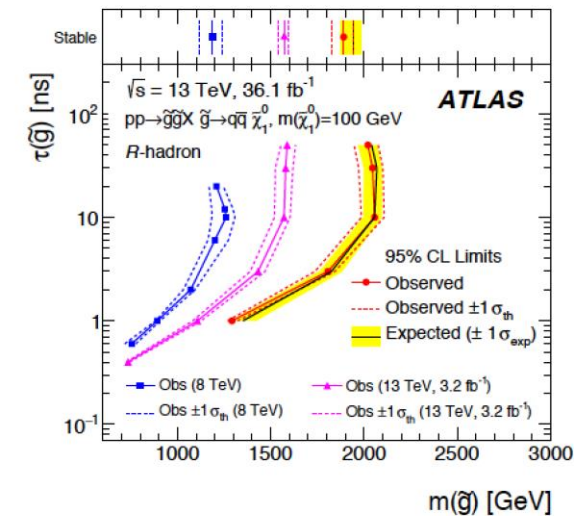

stopped particles

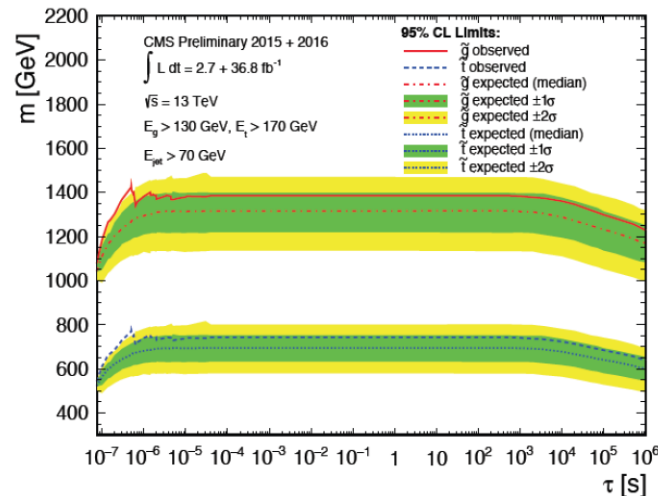

Hidden Valley searches

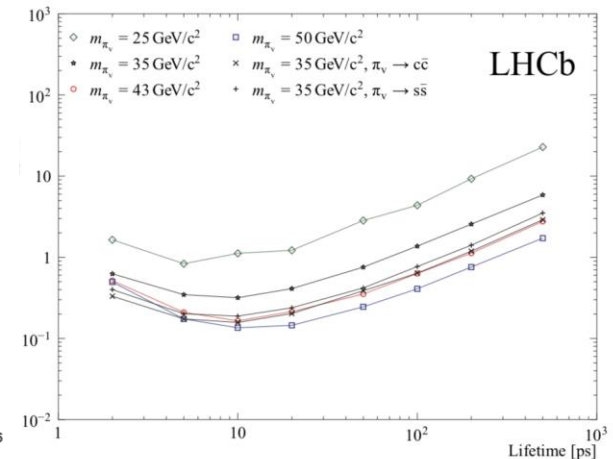

Multi Charged Particles

Pixel tracker

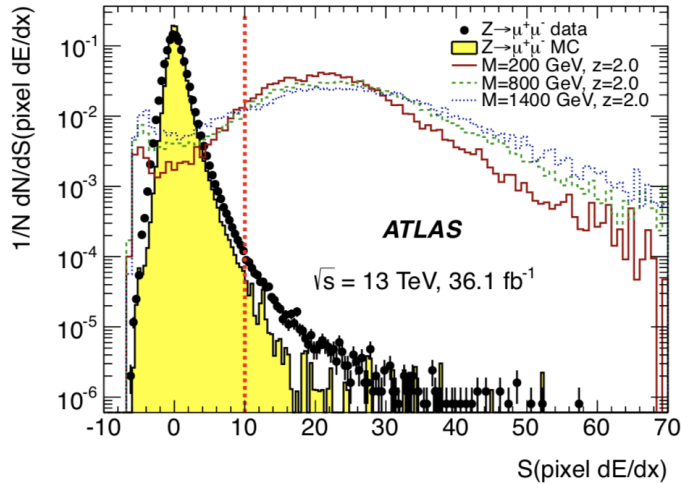

TRT tracker

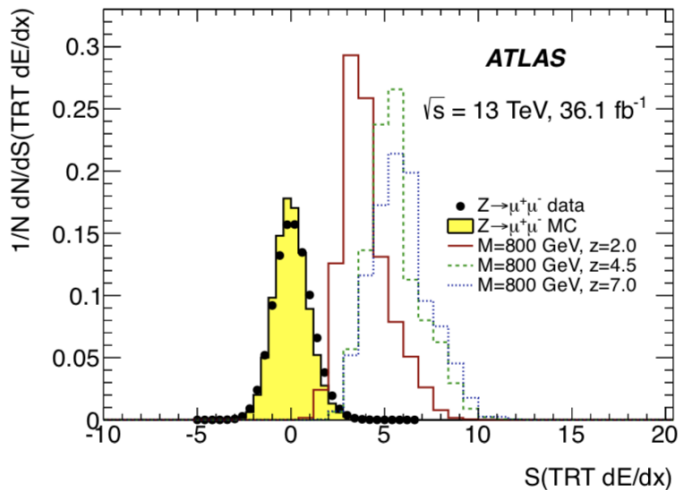

Use central tracker and dE/dx measurement to search for particles with electric charges of $2e$ to $7e$

arXiv:1812.03673

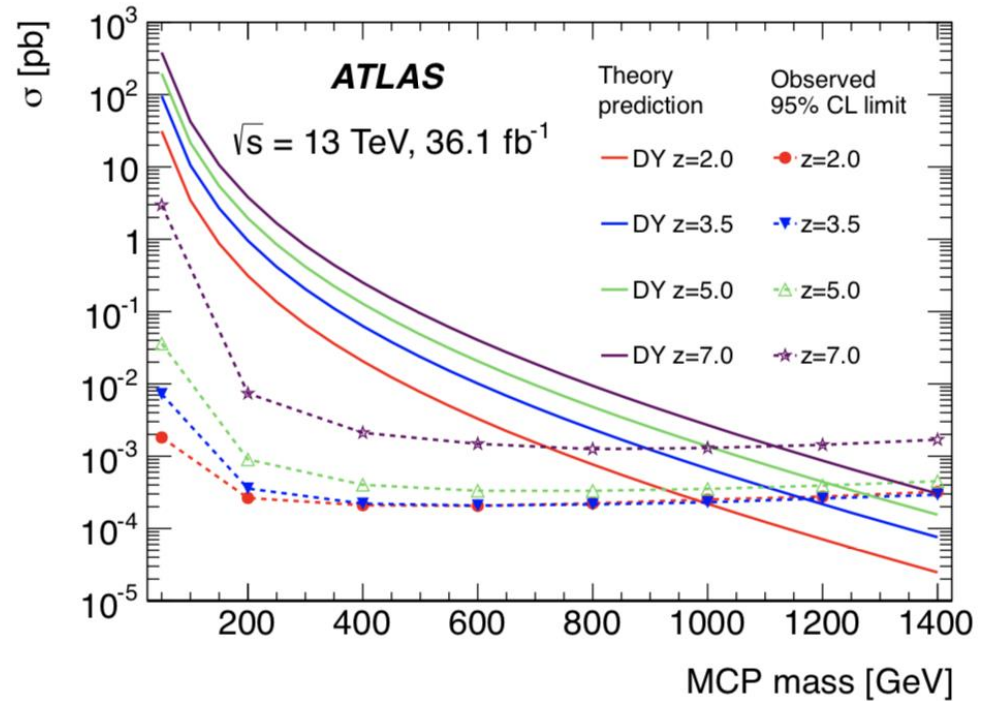

Exclusion between 50 GeV and 980-1220 GeV

Search for Delayed Jets

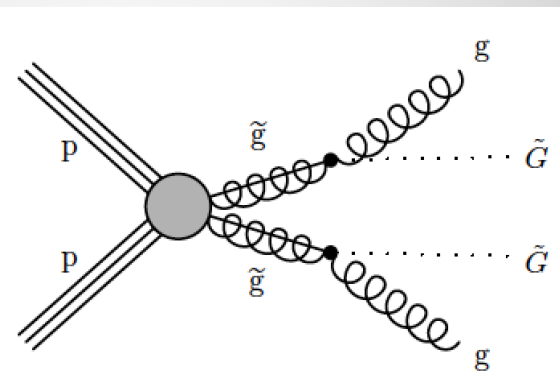
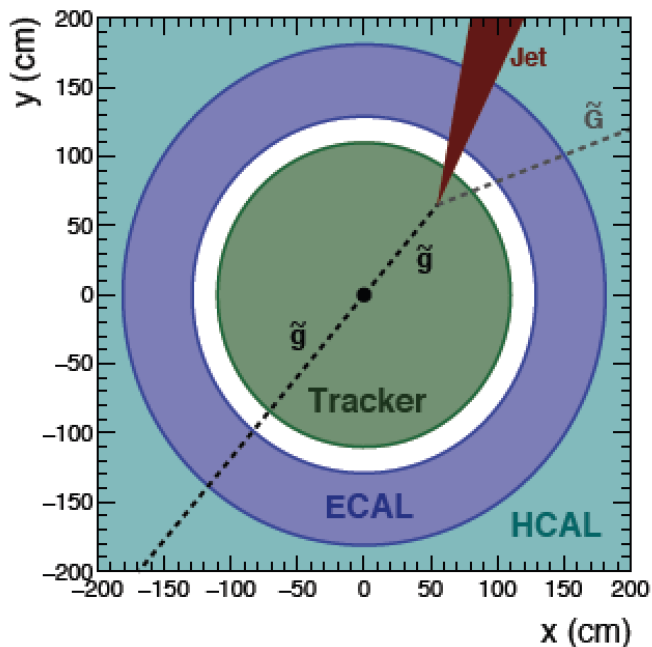

Background	Prediction
Beam halo	$0.02^{+0.06}_{-0.02}$ (stat) $^{+0.05}_{-0.01}$ (syst)
Core and satellite bunches	$0.11^{+0.09}_{-0.05}$ (stat) $^{+0.02}_{-0.02}$ (syst)
Cosmics	$1.0^{+1.8}_{-1.0}$ (stat) $^{+1.8}_{-1.0}$ (syst)

EXO-19-001

- Using the ECAL precision timing ~ 200 ps
- Search for jets not connected to the primary vertex
- Data driven background estimate

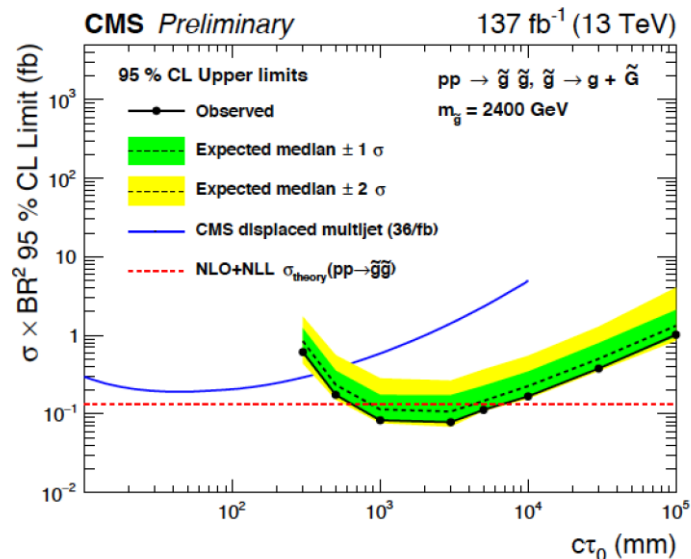
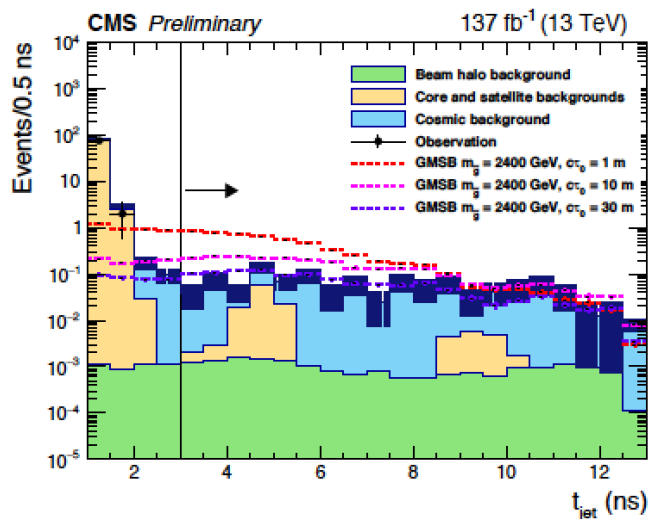

GMSB long-lived gluino model search. Mass limits up to 2500 GeV

Heavy Neutral Leptons

Neutrino portal: ν MSM (Neutrino Minimal Standard Model)

Minimal extension of the SM fermion sector by Right Handed HNLs: N_1, N_2, N_3 .

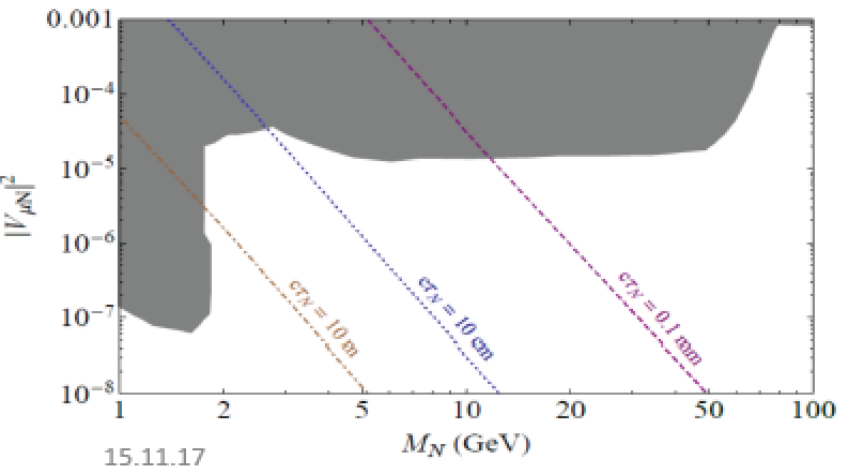
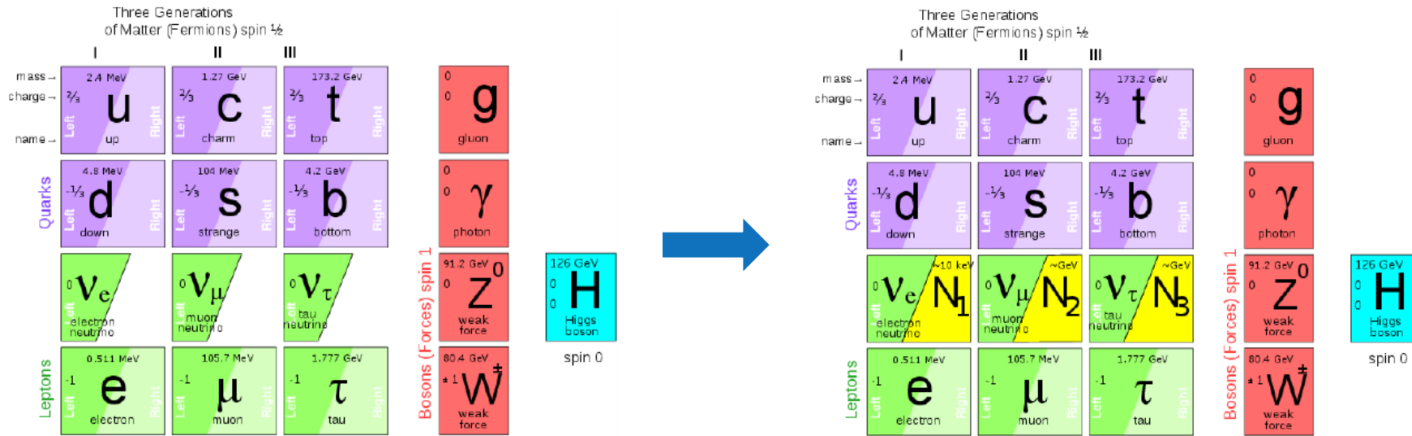

D.Gorbunov, M.Shaposhnikov JHEP 0710 (2007) 015

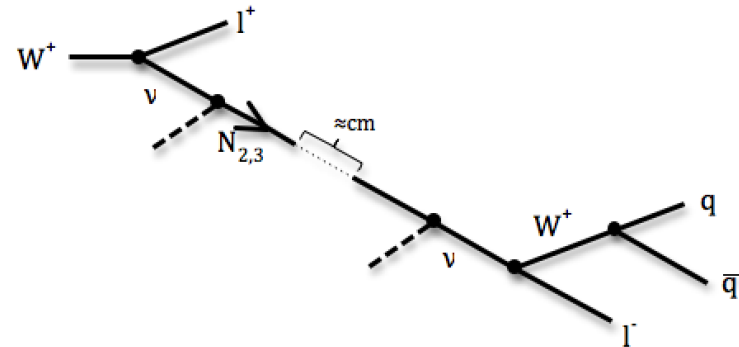

First LHC results on prompt studies
Majorana/Dirac? Now studies with displaced jets/lepton analyses. $L \sim 1\text{m}$?

Search for Heavy Neutral Leptons

Neutrino portal: ν MSM (Neutrino Minimal Standard Model)

Minimal extension of the SM fermion sector by Right Handed HNLs: N_1, N_2, N_3 .

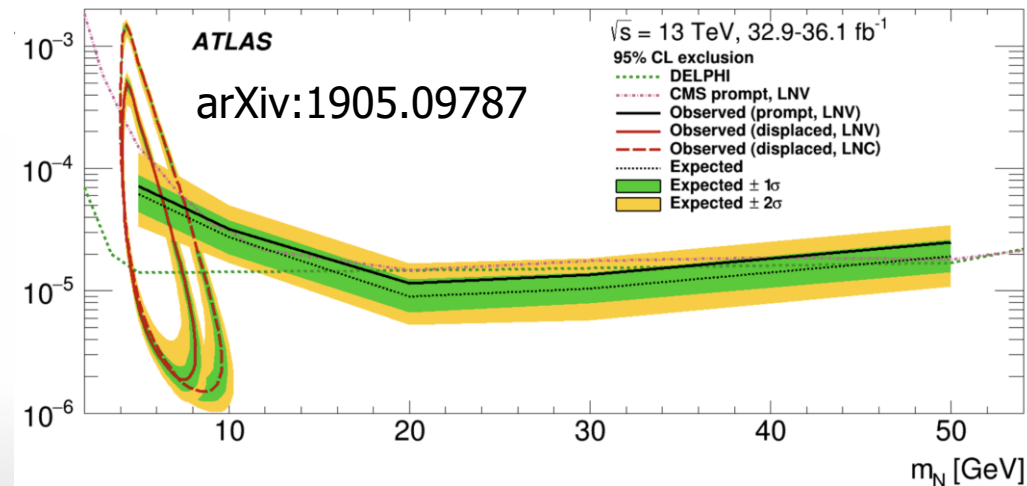
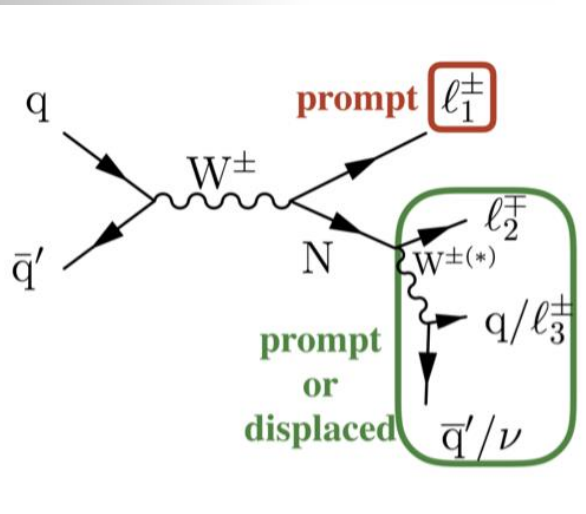
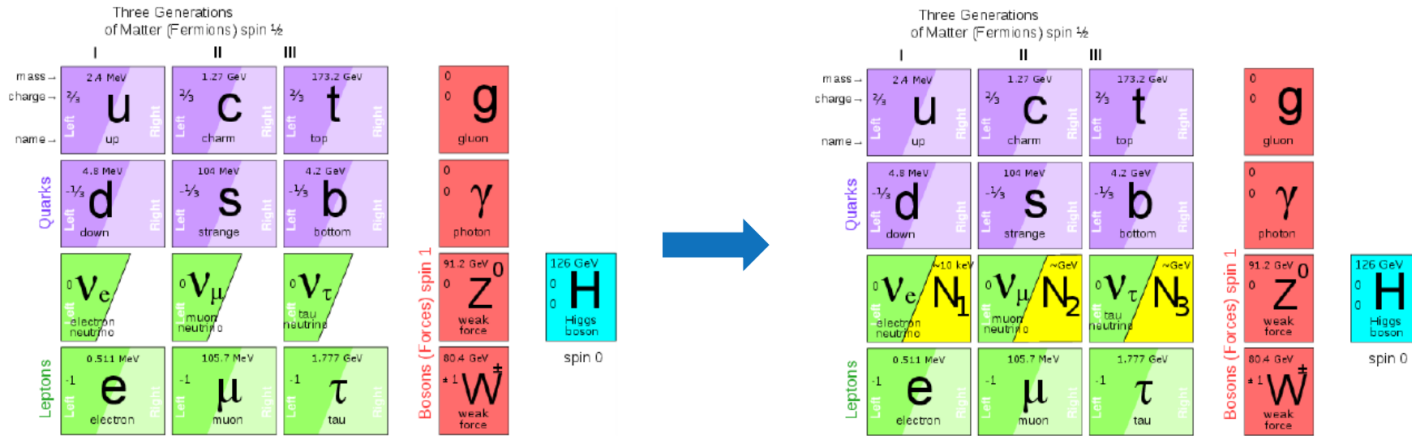

-> HNL hunting also focus of the SHIP experiment proposal

Monopoles

Magnetic Monopoles to explain the quantization of electric charge (Dirac '31)

$$\nabla \cdot \mathbf{E} = 4\pi \rho_e$$

$$\nabla \cdot \mathbf{B} = 4\pi \rho_m$$

$$-\nabla \times \mathbf{E} = \frac{1}{c} \frac{\partial \mathbf{B}}{\partial t} + \frac{4\pi}{c} \mathbf{j}_m$$

$$\nabla \times \mathbf{B} = \frac{1}{c} \frac{\partial \mathbf{E}}{\partial t} + \frac{4\pi}{c} \mathbf{j}_e$$

$$\mathbf{F} = q_e \left(\mathbf{E} + \frac{\mathbf{v}}{c} \times \mathbf{B} \right) + q_m \left(\mathbf{B} - \frac{\mathbf{v}}{c} \times \mathbf{E} \right)$$

$$eg = n\hbar c/2 = ng_D = \mathbf{n 68.5e}$$

$$\sigma_{D(m)} = \left(\frac{g_D}{e} \right)^2 \times \sigma_{\mu\mu}(> 2m) \times \left(1 - 4 \frac{m^2}{s} \right)$$

Simplifies Maxwell equations

Searched for at all colliders

Tevatron direct limits ~ 400-800 GeV

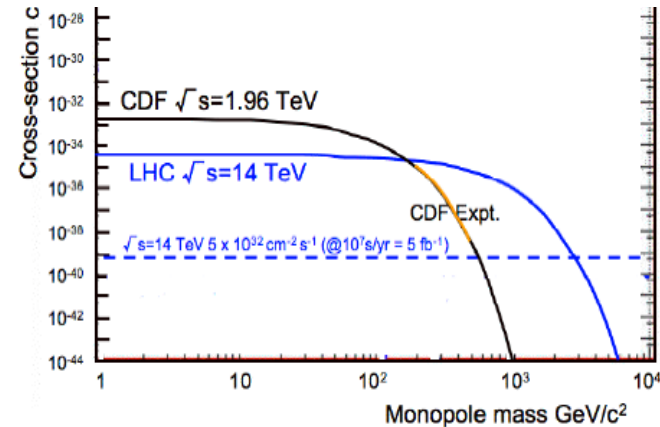
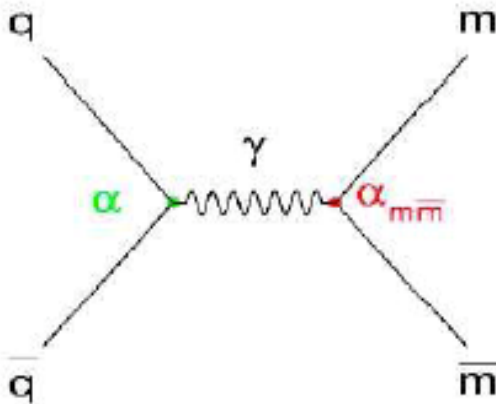

Sensitivity of LHC experiments to exotic highly ionising particles

A. De Roeck^[1,2,3], A. Katre^[4], P. Mermod^[a,4,5],
D. Milstead^[6], T. Sloan^[7]

arXiv: 1112.2999

Monopole Searches: MoEDAL @ 13TeV

2016 data analysis base on 794 kg Aluminium to "stop" the monopoles and search for them with a SQUID precision magnet (4.0fb^{-1}) arXiv:1903.08491

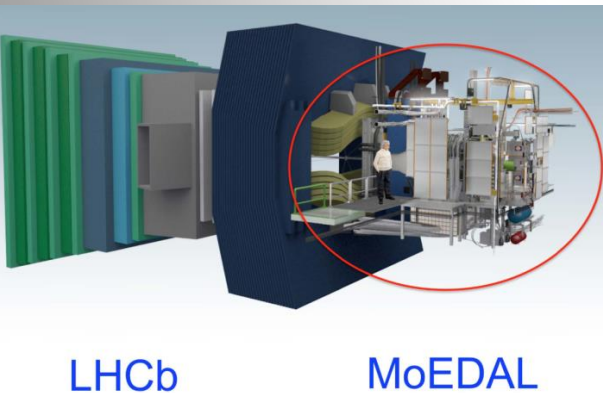
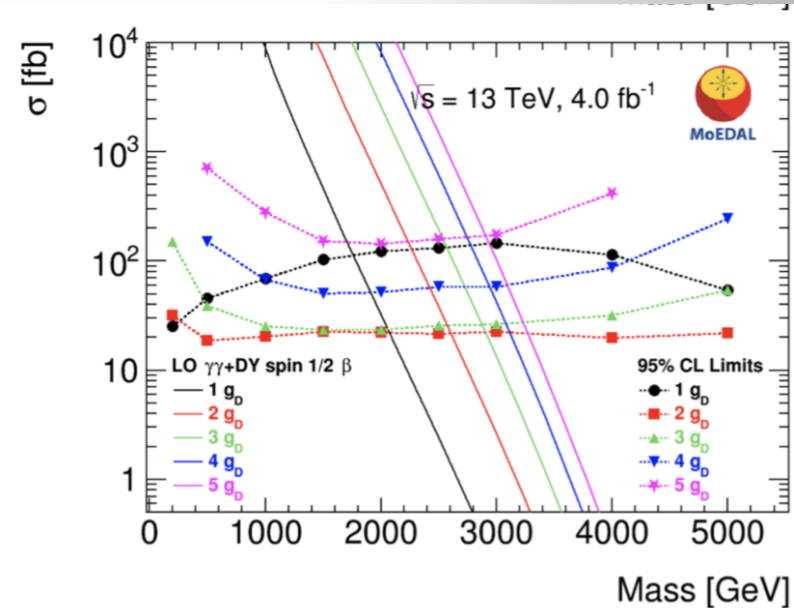
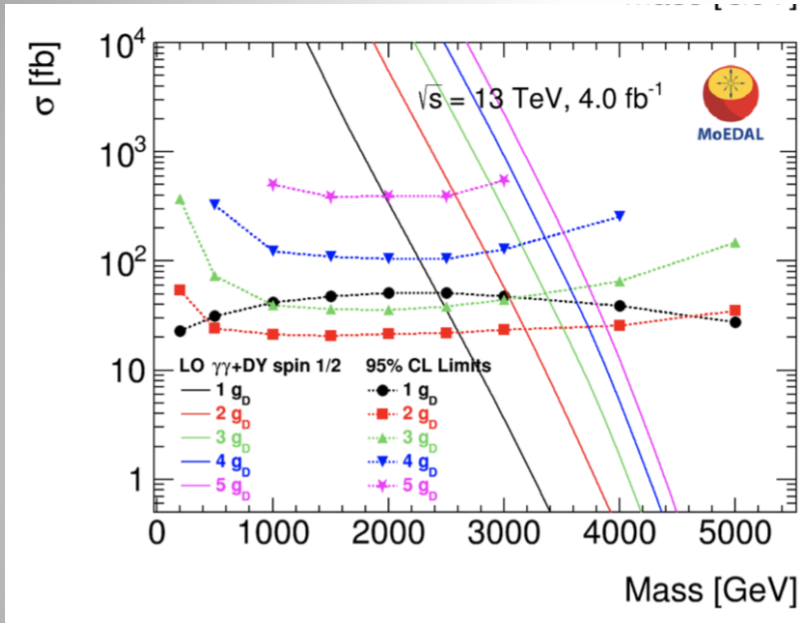

Process / coupling	Spin	Magnetic charge [g_D]				
		1	2	3	4	5
95% CL mass limits [GeV]						
DY+ $\gamma\gamma$	0	2190	2930	3120	3090	–
DY+ $\gamma\gamma$	1/2	2420	3180	3360	3340	–
DY+ $\gamma\gamma$	1	2920	3620	3750	3740	–
DY+ $\gamma\gamma$ β -dep.	0	1500	2300	2590	2640	–
DY+ $\gamma\gamma$ β -dep.	1/2	1760	2610	2870	2940	2900
DY+ $\gamma\gamma$ β -dep.	1	2120	3010	3270	3300	3270

-> See J. Pinfold

- Limits for different monopole charges
- First monopole search result @LHC at 13 TeV
- No signal yet.

Monopoles Stopped in the Beampipe

ADR et al., Eur. Phys. J. C72 (2012) 2212

Test performed with pieces of material from the LHC from 18 m away from the interaction region

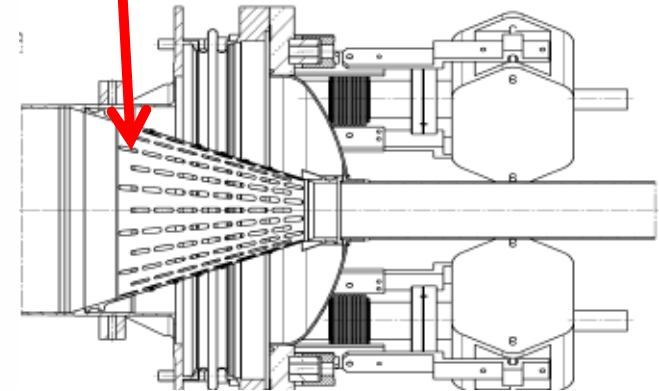
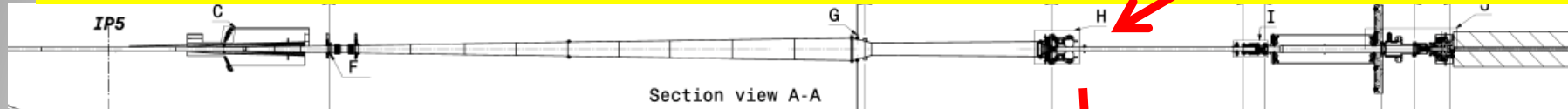

$$|g| \geq 4g_D$$

Faulty connecting "fingers" were removed and scanned in a SQUID in Zurich

Want to use the 2012 CMS beampipe! MoEDAL officially got it since 18/2/2019!!
A beampipe analysis effort has been put into place in MoEDAL
-> The analysis preparation effort is starting now

New: ATLAS Monopole Search

arXiv:1903.08491

Use high ionization in the transition radiation tracker and pencil-like energy deposit in the ECAL

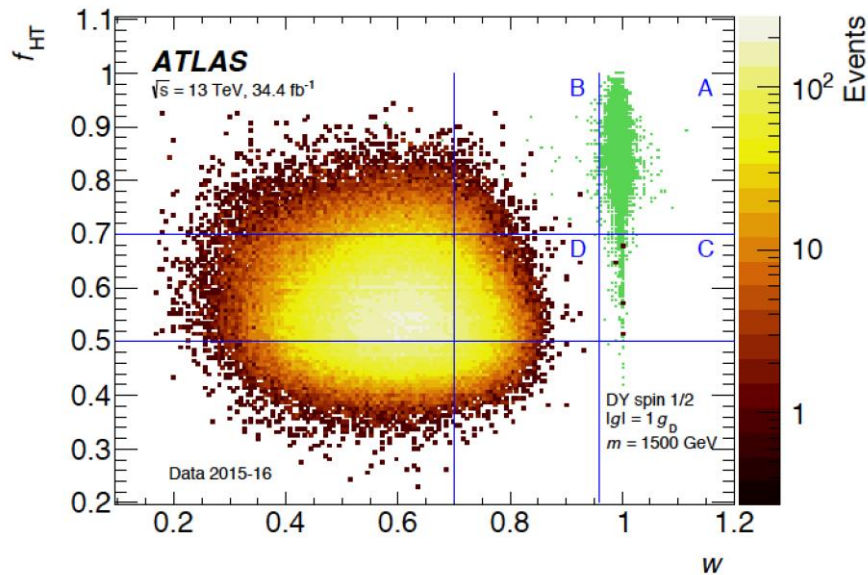

2016 data

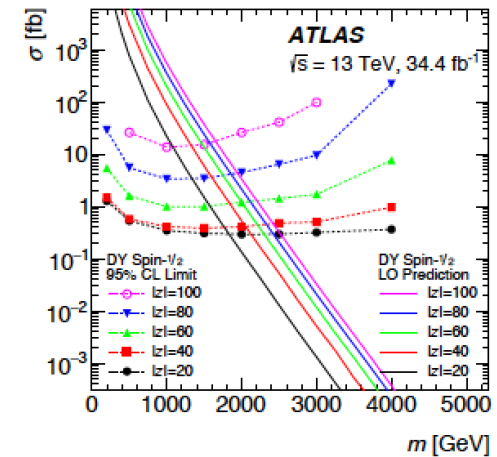
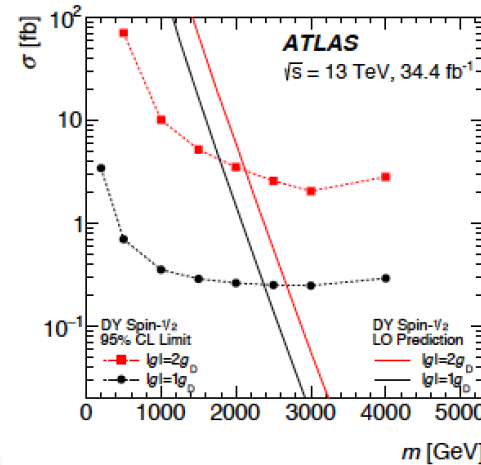
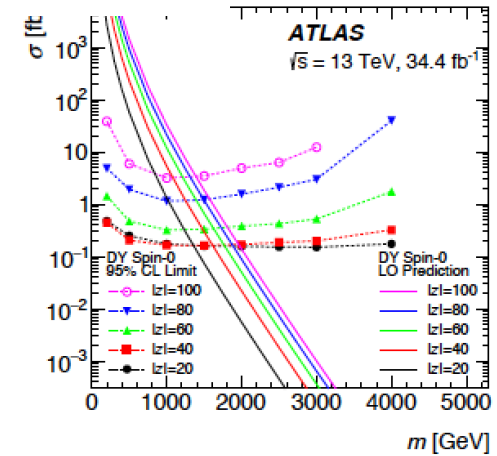
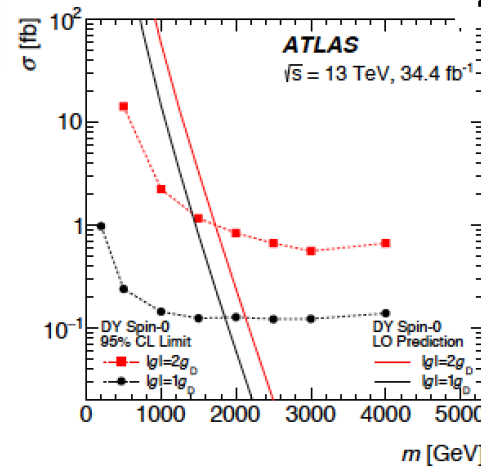

Results interpreted via Drell-Yan production for Dirac charges 1 and 2

LHC Monopole Searches

V. Mitsou

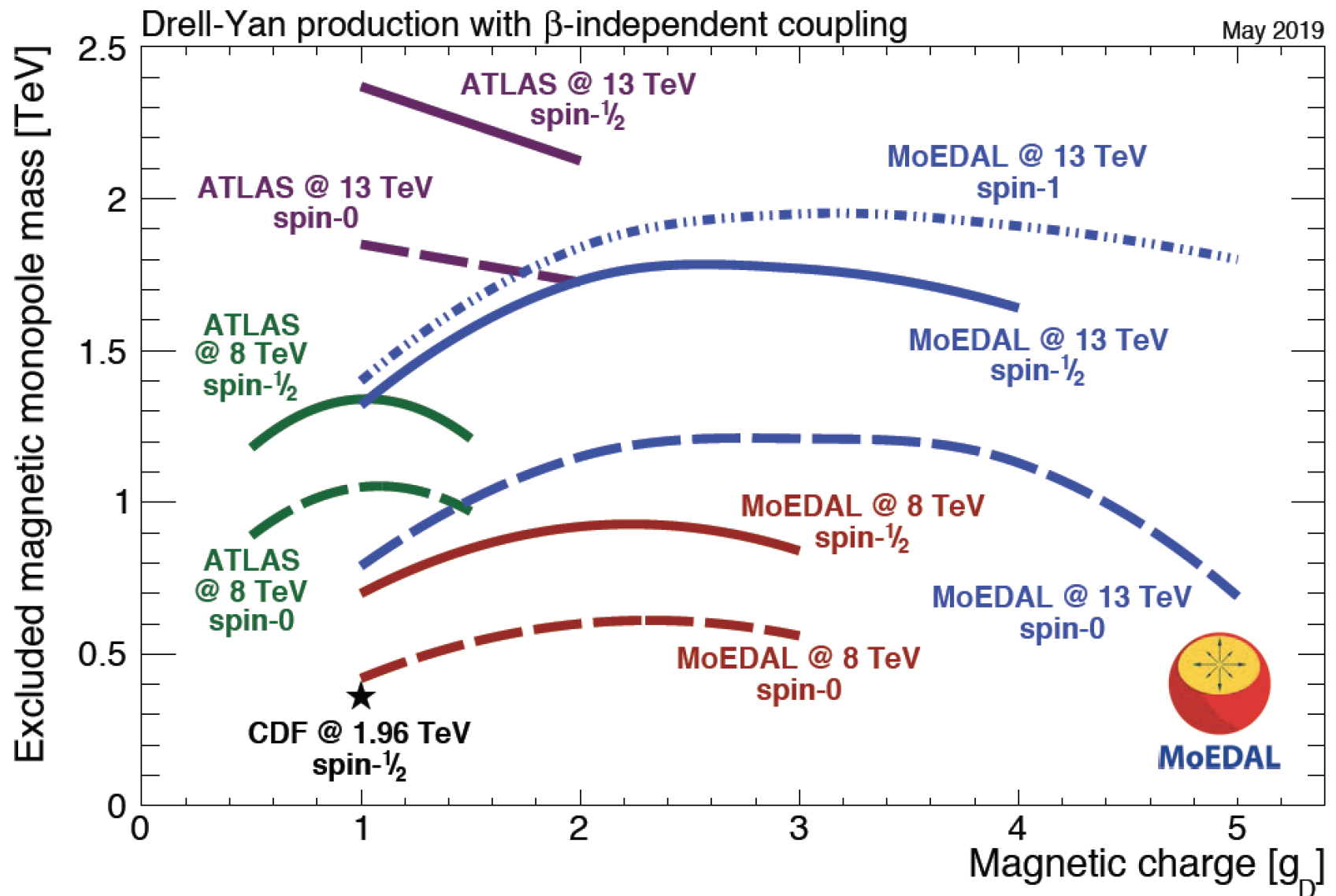

Proposals for New Experiments @LHC

MilliQan: searches for millicharged particles
MAPP: Same from MoEDAL

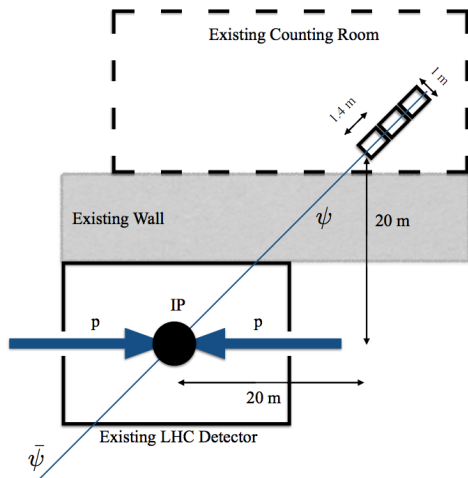

CODEX-b: searches for long lived weakly interacting neutral particles

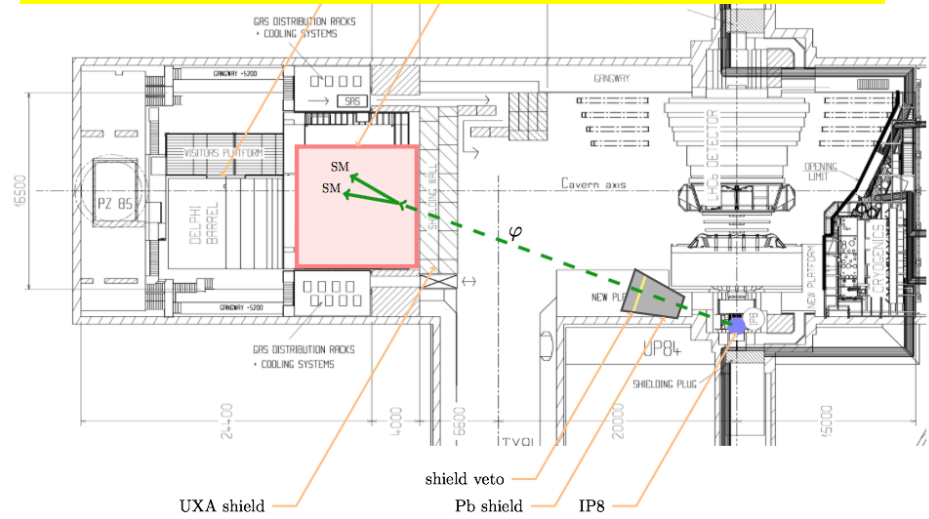

MATHUSLA: searches for long lived weakly interacting neutral particles

FASER: searches for long lived dark photons-like particles

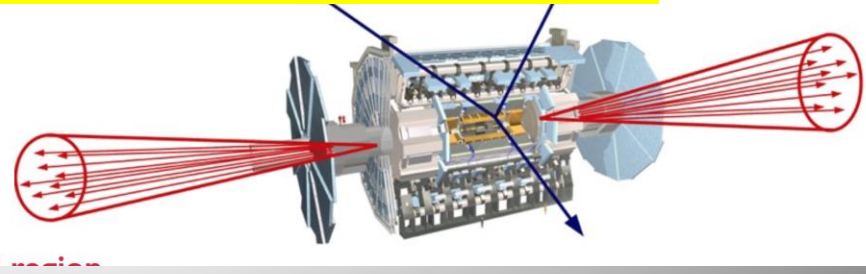
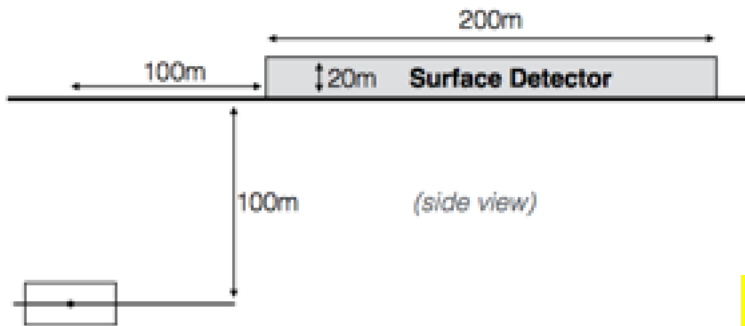

New: **AL3X** ('ALICE' for LLP arXiv.1810.03636)...

Particles with Milli-Charges?

"New" idea -> Hunting for particles with charges $\sim 0.3-0.001e$

Baseline paper: arXiv:1410.6816

Proposal for a new experiment/CMS subdetector.

Demonstrator (1%) taking data since mid-2017

A Letter of Intent to Install a Milli-charged Particle Detector at

arXiv:1607.04669

LHC P5

Austin Ball,¹ Jim Brooke,² Claudio Campagnari,³ Albert De Roeck,¹ Brian Francis,⁴
 Martin Gastal,¹ Frank Golf,³ Joel Goldstein,² Andy Haas,⁵ Christopher S. Hill,⁴ Eder
 Izaguirre,⁶ Benjamin Kaplan,⁵ Gabriel Magill,^{7,6} Bennett Marsh,³ David Miller,⁸ Theo
 Prins,¹ Harry Shakeshaft,¹ David Stuart,³ Max Swiatlowski,⁸ and Itay Yavin^{7,6}

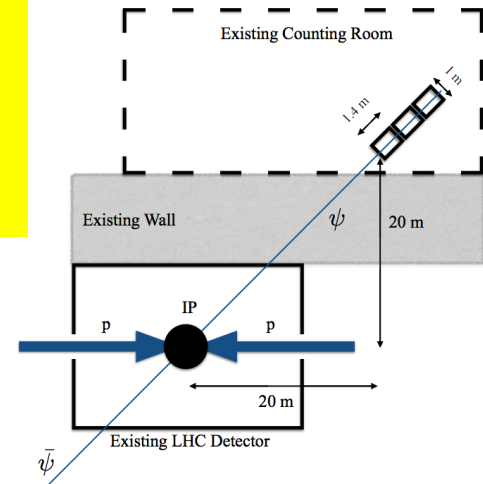

MilliQan Experiment

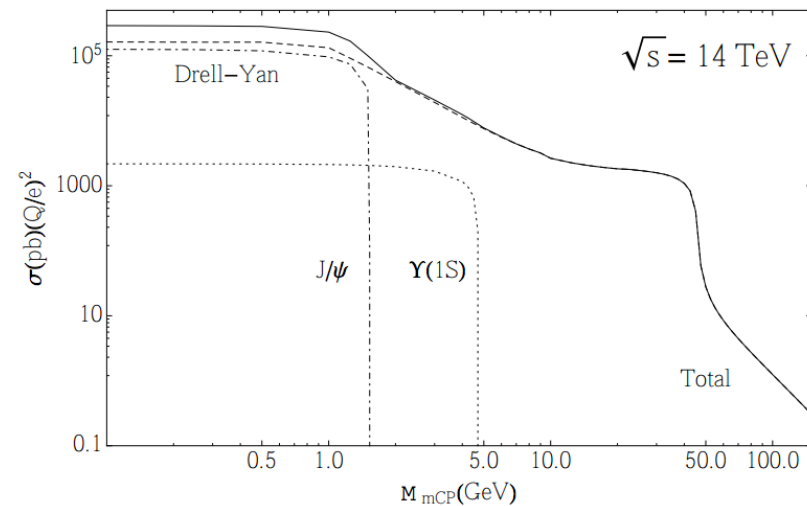
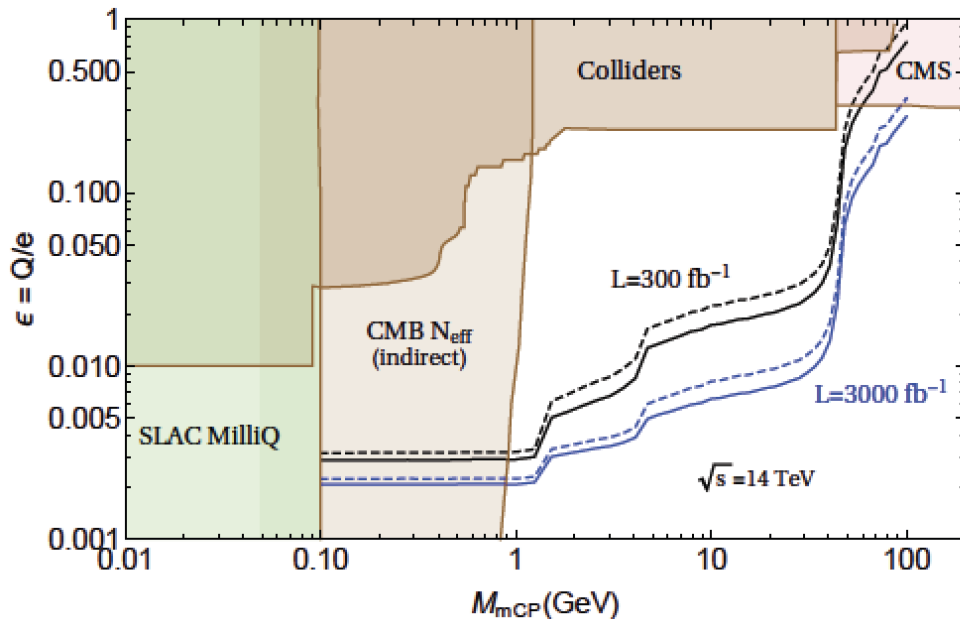

MilliQan Experiment

Installed demonstrator in 2017

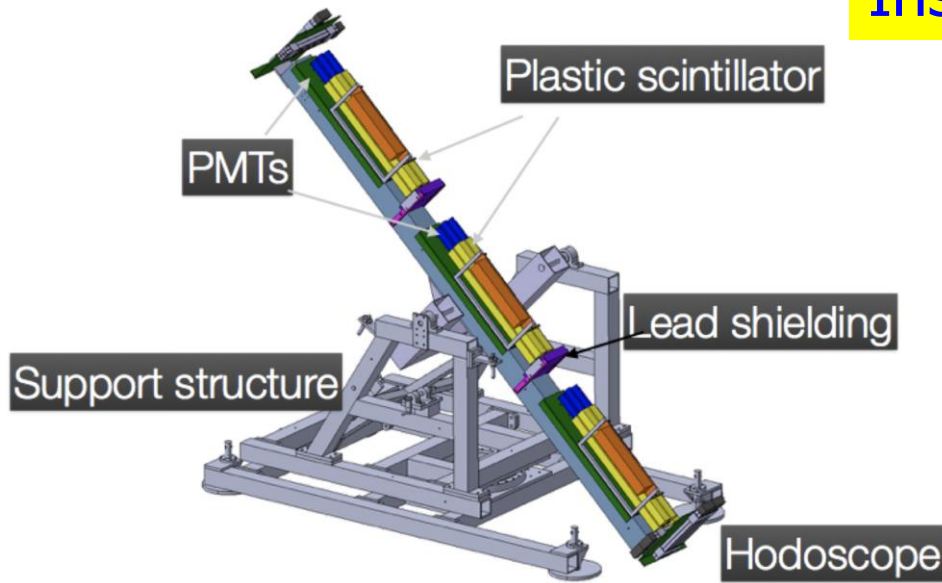

- In order to verify the feasibility and optimize the design of the experiment thoroughly, ~1% of the detector is installed as a “demonstrator”
- 3 layers of 2x3 scintillator+PMT

- Took data since September 2017
→ ~100 fb⁻¹ of data on tape
- Data well understood!
- First physics paper on these data?

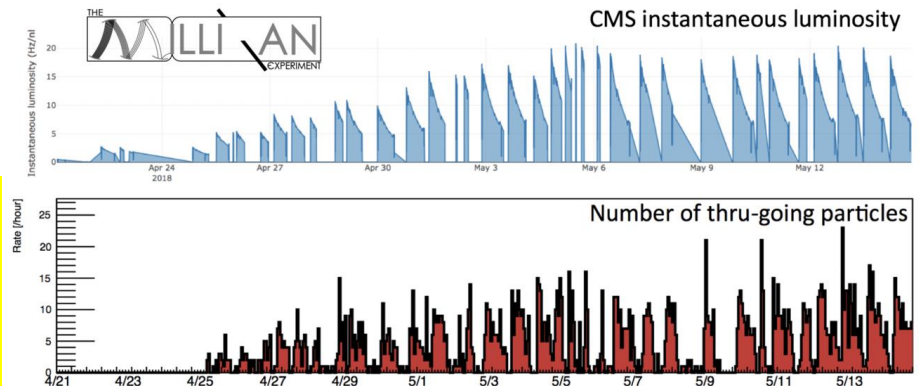

MAPP* MoEDAL's Upgrade for RUN-3

**(MoEDAL Apparatus for Penetrating Particles)*

- **The Milli-charged particle (mQP) detector is a 1m x 1m x (2 x 1.5m) scintillator array, pointing to IP, in well shielded area of LHC Point 8 (LHCb)**
- **Placed in UGC8 gallery ~100m underground
Positioned at 55m from IP, 50m through rock, in the horizontal beam plane**
- **Deployed from 5° to the beam (at 55m) to 25° to the beam (at 26 m)**
- **7-10m decay zones available in from of**
- **Uses quadruple coincide between the two scintillator bars sections (2 PMTs per bar)**
- **Active veto against showers in rock**
- **Under construction during current shutdown**
- **Due to start data taking in LHC's RUN-3**

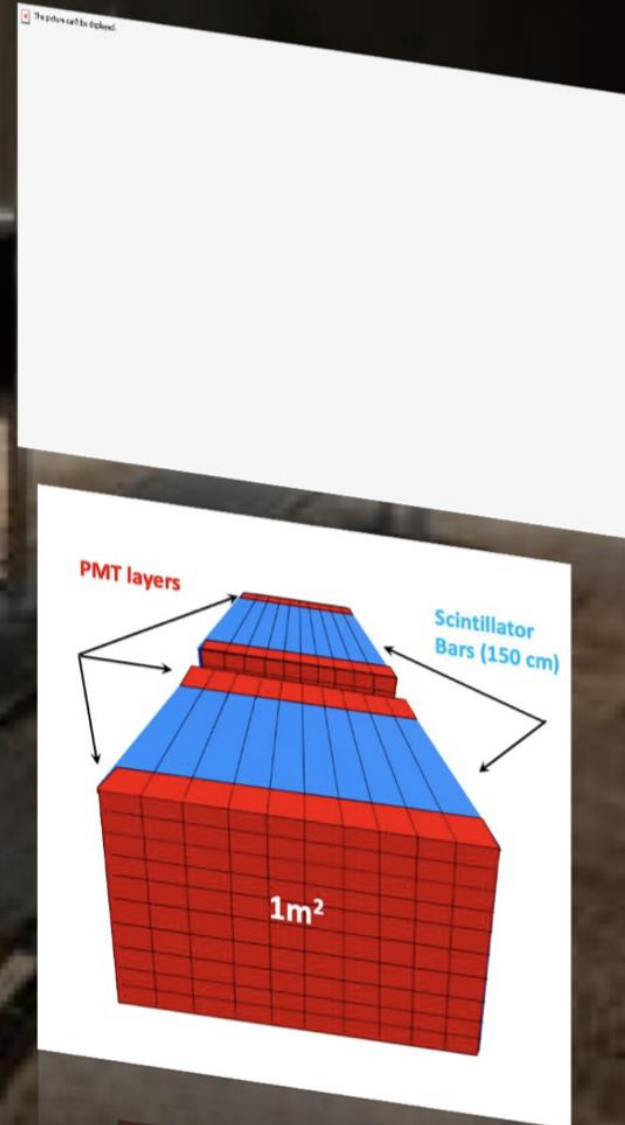

MAPP @ MoEDAL

MAPP Sensitivity

- MAPP will enable the search for particles with charge as low as $\sim .001e$ and masses above ~ 100 MeV.
- Simulations indicate that with 30 fb^{-1} :
 - We will have sensitivity to a charge of $\mathcal{O}(10^{-2})e$ to $\mathcal{O}(10^{-3})e$ can be achieved for masses of $\mathcal{O}(1)$ GeV, and charge $\mathcal{O}(10^{-2})e$ for masses of $\mathcal{O}(10)$ GeV.
- For RUN-3 lumi delivered to MoEDAL (& LHCb) will rise by a factor of ~ 5 reducing the lumi disadvantage at IP8 to a factor of ~ 10 compared to ATLAS and CMS
- But, the forward stance of MAPP (at 5° to the beam) can roughly cancel the lumi benefit – for “forward-backward” biased physics signals – of centrally placed detectors

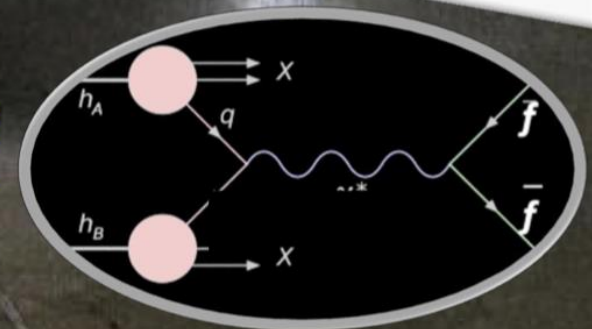
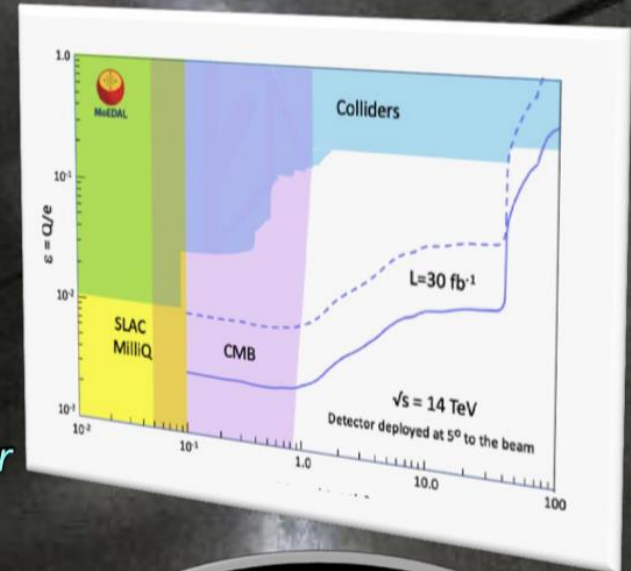

The direct and indirect bounds on mQPs for models with a massless dark photon and the projected reach of MAPP for RUN-3 (---line 10% overall MAPP eff.)

MATHUSLA



A Letter of Intent for MATHUSLA: a dedicated displaced vertex detector above ATLAS or CMS

A proposal for a large area surface array to detect ultra long lived particles coming from the pp collisions

Aim to cover the range

$$c\tau \lesssim 10^7 - 10^8 \text{ m.}$$

~ BBN constrained inspired

Physic case arXiv:1806.07396

Cristiano Alpigiani,^a Austin Ball,^o Liron Barak,^c James Beacham,^{ah} Yan Benhammo,^c Tingting Cao,^c Paolo Camarri,^{f,g} Roberto Cardarelli,^f Mario Rodríguez-Cahuantzi,^h John Paul Chou,^d David Curtin,^b Miriam Diamond,^e Giuseppe Di Sciascio,^f Marco Drewes,^x Sarah C. Eno,^u Erez Etzion,^c Rouven Essig,^q Jared Evans,^v Oliver Fischer,^w Stefano Giagu,^k Brandon Gomes,^d Andy Haas,^l Yuekun Heng,^z Giuseppe Iaselli,^{aa} Ken Johns,^m Muge Karagoz,^u Luke Kasper,^d Audrey Kvam,^a Dragoslav Lazic,^{ae} Liang Li,^{af} Barbara Liberti,^f Zhen Liu,^y Henry Lubatti,^a Giovanni Marsella,ⁿ Matthew McCullough,^o David McKeen,^p Patrick Meade,^q Gilad Mizrahi,^c David Morrissey,^p Meny Raviv Moshe,^c Karen Salomé Caballero-Mora,^j Piter A. Paye Mamanj,^{ab} Antonio Policicchio,^k Mason Proffitt,^a Marina Reggiani-Guzzo,^{ad} Joe Rothberg,^a Rinaldo Santonico,^{f,g} Marco Schioppa,^{ag} Jessie Shelton,^t Brian Shuve,^s Martin A. Subieta Vasquez,^{ab} Daniel Stolarski,^r Albert de Roeck,^o Arturo Fernández Téllez,^h Guillermo Tejada Muñoz,^h Mario Iván Martínez Hernández,^h Yiftah Silver,^c Steffie Ann Thayil,^d Emma Torro,^a Yuhsin Tsai,^u Juan Carlos Arteaga-Velázquez,ⁱ Gordon Watts,^a Charles Young,^e Jose Zurita.^{w,ac}

arXiv:1811-00927

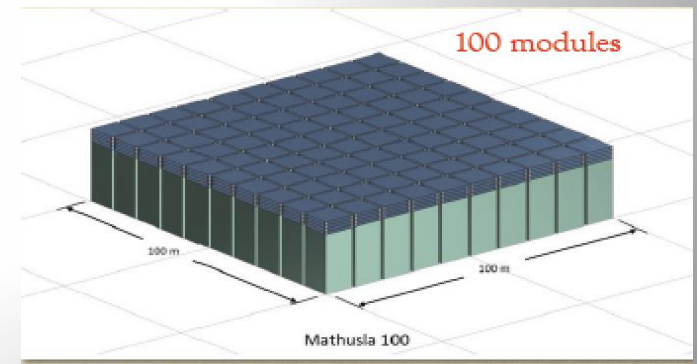
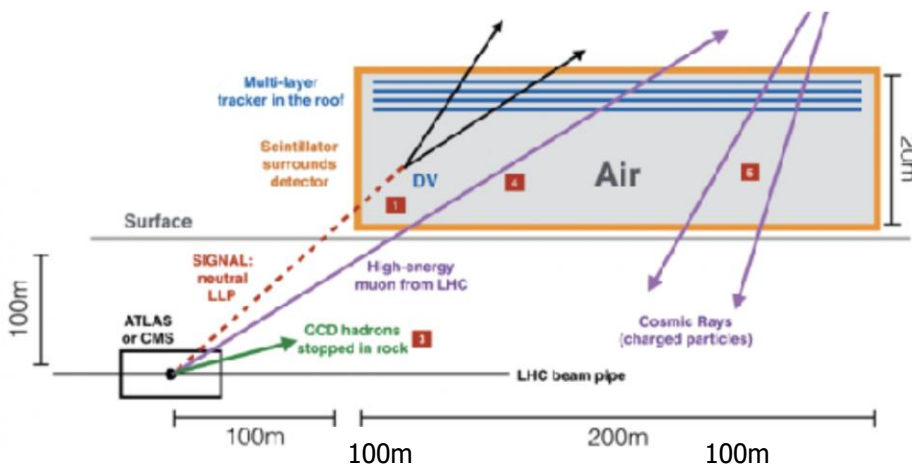

Detector surface array eg above ATLAS or CMS: $\sim (200\text{m})^2$

MATHUSLA

- **MATHUSLA: MAsive Timing Hodoscope for Ultra Stable neutral pArticles**

Recent developments

- The current MATHUSLA detector concept is 100x100 m² located at the surface of CMS
- Currently working with CERN civil engineers to:
 - determine the feasibility of excavating to install MATHUSLA slightly below surface
 - and feasibility of building a structure (building) with crane coverage to house MATHUSLA

- 100m x 100m experimental area
- 30m x 100m assembly area
- ~7.5m offset to center of beam
- ~68m to IP

- Not on surface but make 5-10m deep hole to put it in.
- Use scintillators instead of RPCs for the tracking stations

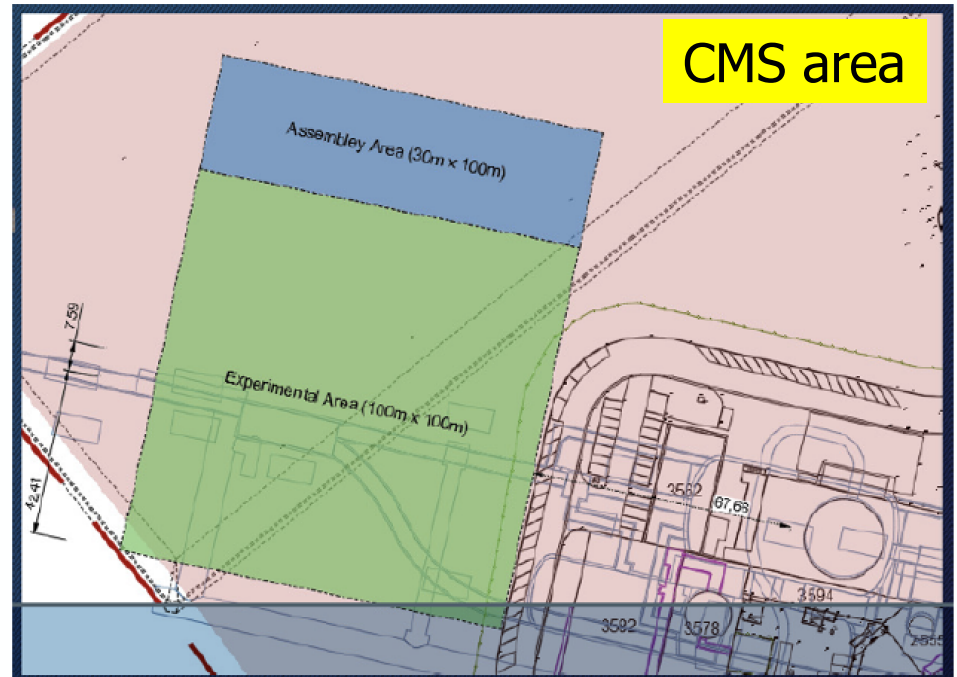

CODEX-b Proposal

CODEX-b

1708.09395: V. Gligorov, SK, M. Papucci, D. Robinson

An LLP detector in the LHCb area

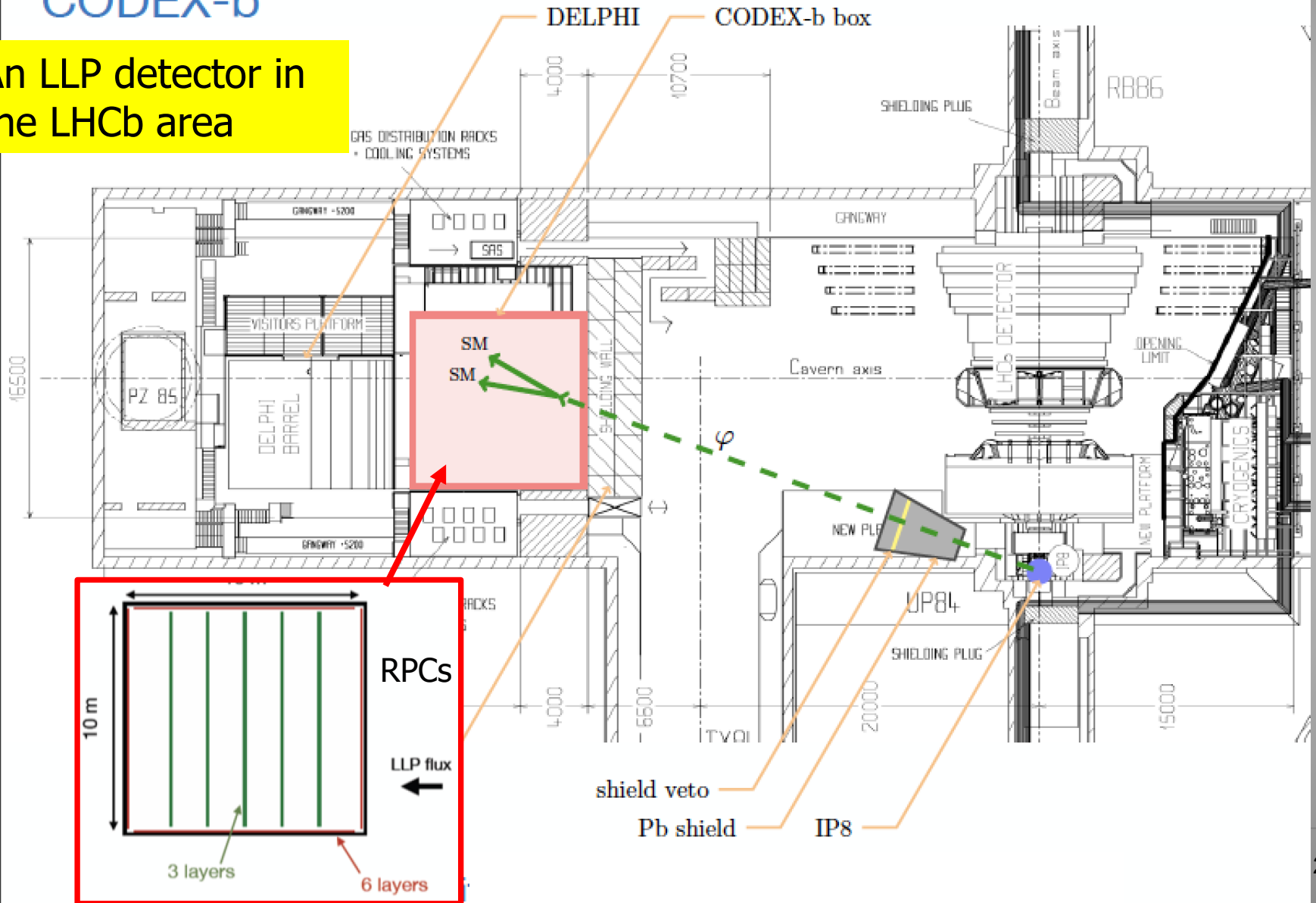

CODEX-b Proposal

Example: Higgs-scalar mixing

- Minimal extension of Higgs sector: $\mathcal{L} \sim \mu\varphi HH^\dagger + \frac{\lambda}{2}\varphi^2 HH^\dagger$

$\lambda = 0$:

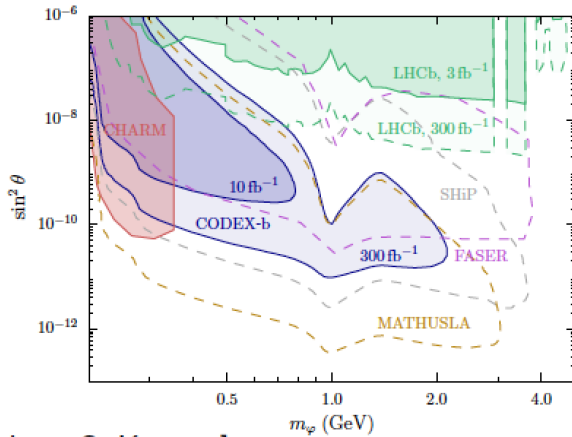

$\lambda = 1.6 \times 10^{-3}$:

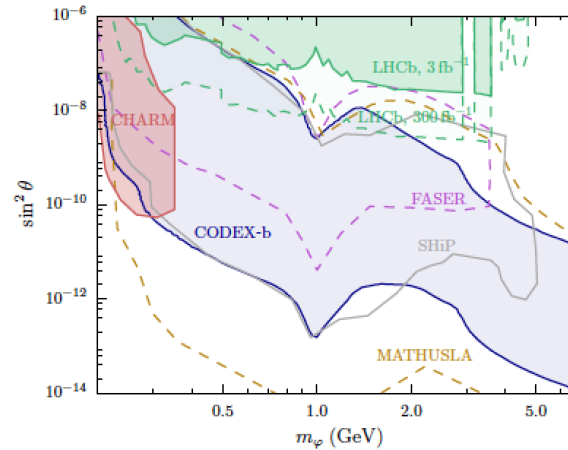

- Scalar portal \rightarrow Dark Higgs/scalars
- Neutrino portal \rightarrow Heavy Neutral Leptons
- Pseudoscalar portal \rightarrow Axion-like particles
- Vector portal \rightarrow Dark photon

[plots: S. Knapen]

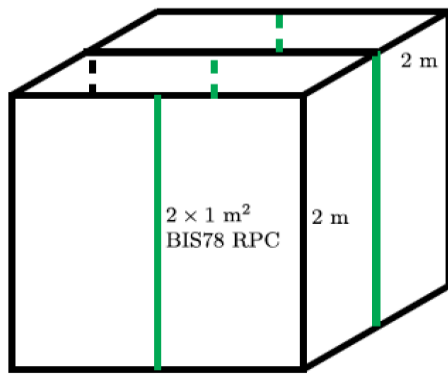

- $2 \times 2 \times 2 \text{ m}^3$ demonstrator for Run 3 \Rightarrow 1/25 of full detector
- 6 faces + 1 inner station \Rightarrow 14 BIS78 triplet chambers.
- Enough space already in D1 area of the cavern once DAQ racks shifted out before EOY.

- Main goal: reconstruct K_L^0 's in the volume from IP8 during 2021-23.

Demonstrator for Run 3

Re-using the ALICE detector?

A Laboratory for Long-Lived eXotics (AL3X)

Reuse the L3 magnet and (perhaps) the ALICE TPC

For LHC Run 5??

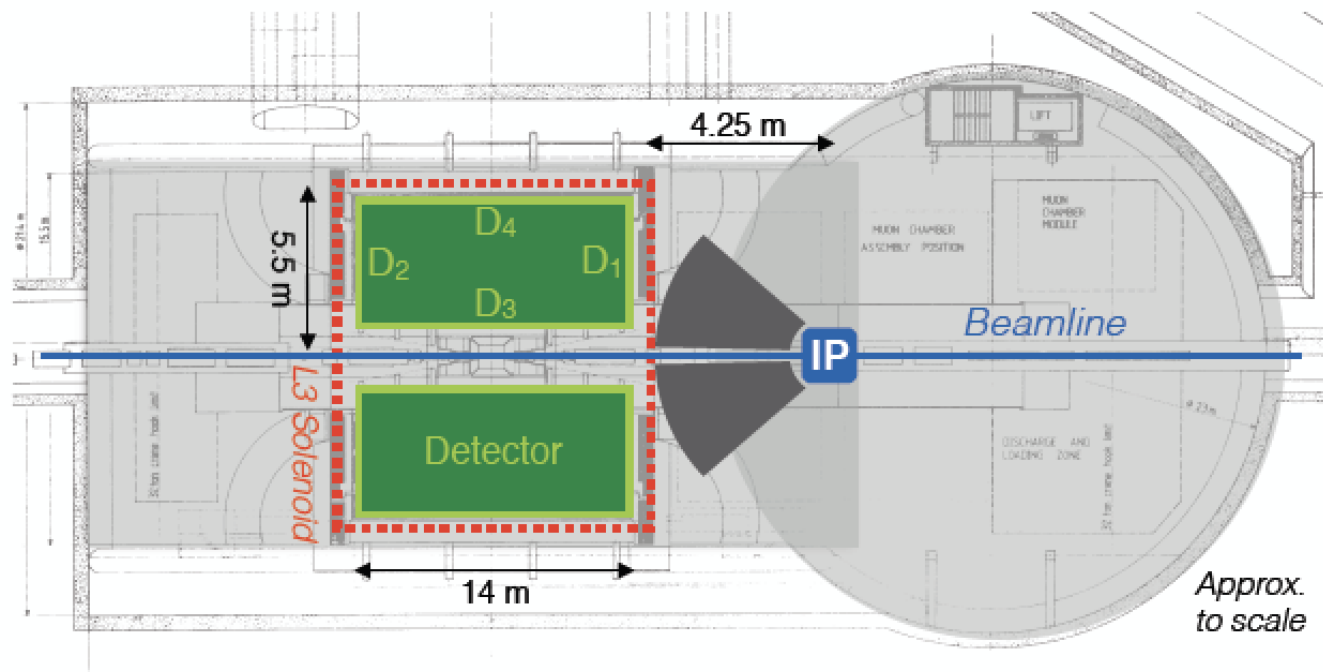

Similar strategy as for CODEX-b: use thick shield with active veto to reduce the backgrounds

Physics Reach: Example

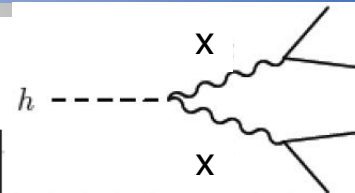
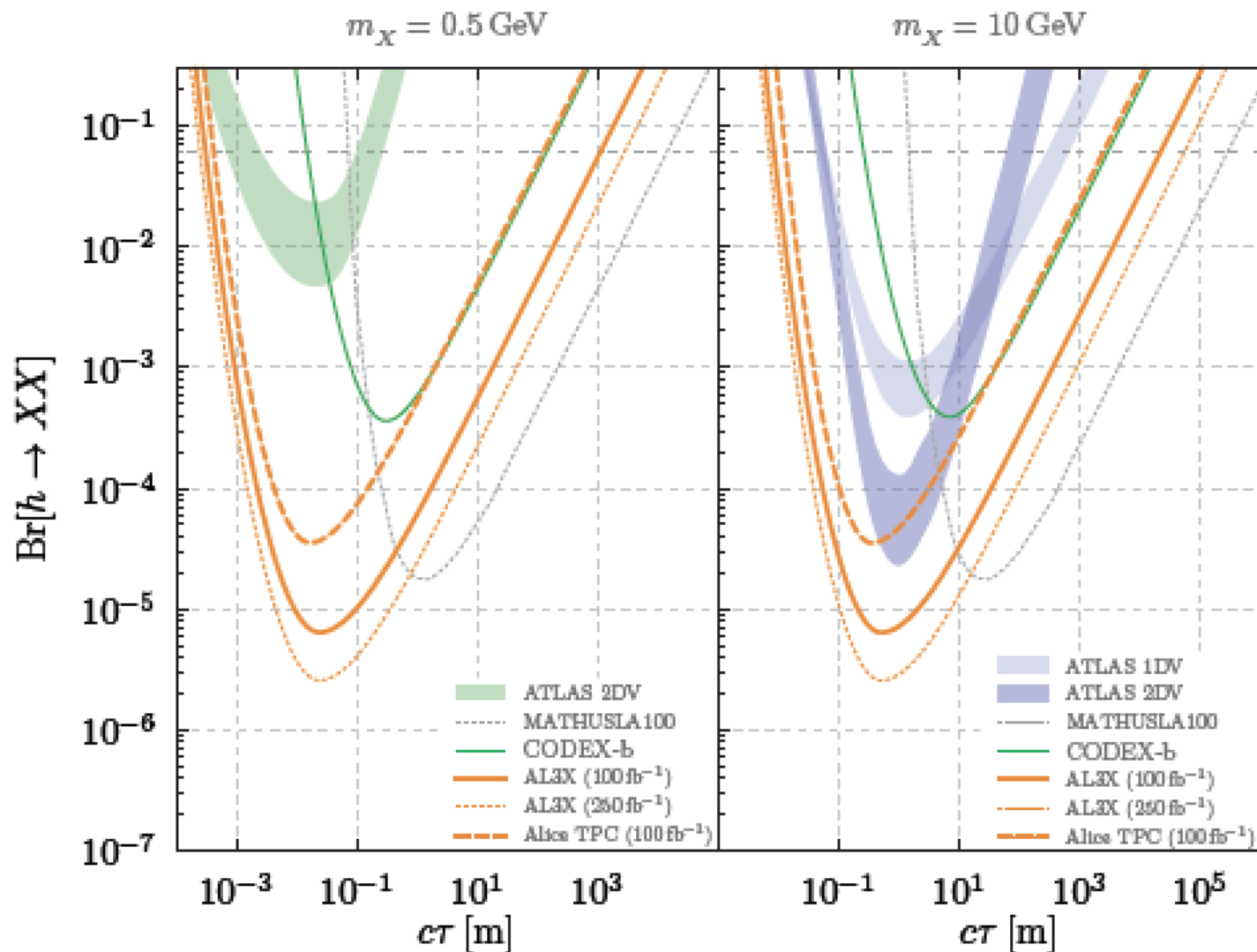

For low masses: MATHUSLA, CODEX-b and AL3X have a leading edge

FASER Proposal

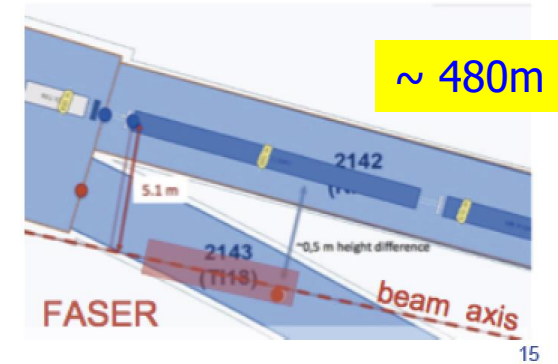
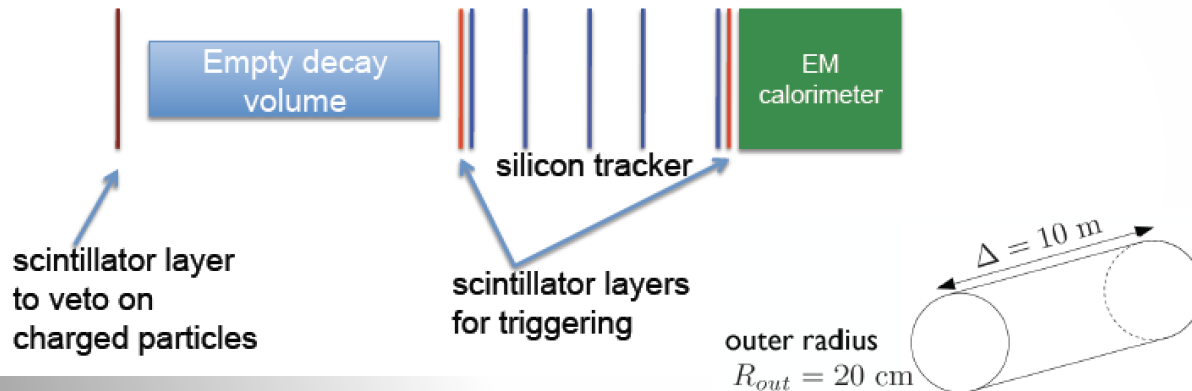
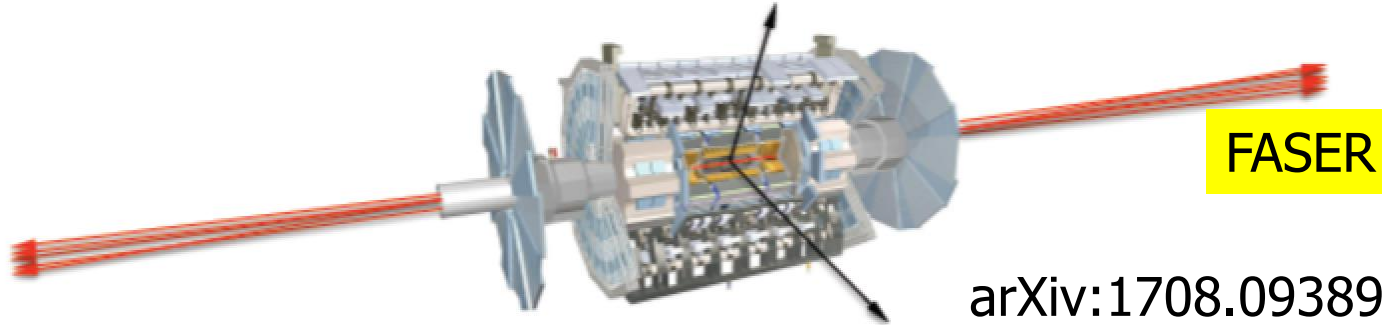

- FASER has significant discovery potential for dark photons dark Higgs bosons, heavy neutral leptons (sterile neutrinos), ALPs, other gauge bosons, and many other new particles.

- Currently have in mind an initial veto layer, followed by ~ 5 tracking layers and EM calorimeter, with volume largely empty and a magnetic field.

FASER Approval

Breaking news: the FASER experiment (phase-I) has been approved March 5th

 INTERACTIONS.ORG
PARTICLE PHYSICS NEWS AND RESOURCES

FASER: CERN approves new experiment to look for long-lived, exotic particles

Date Issued

March 5th, 2019

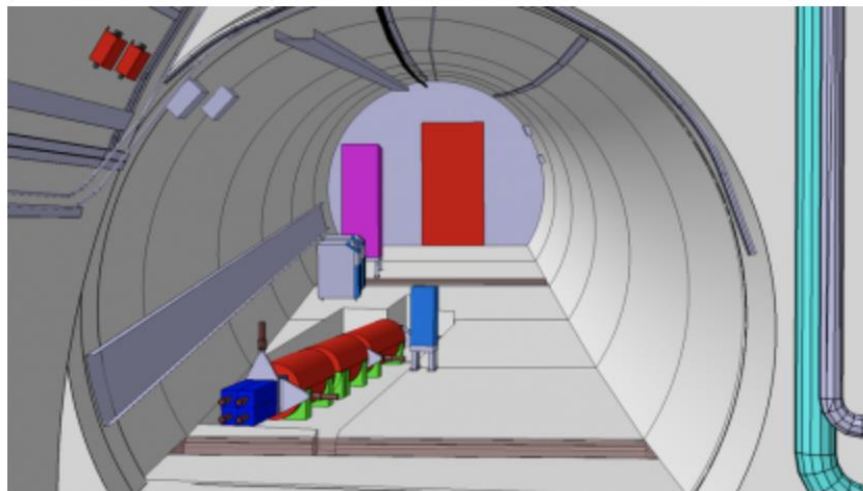

THE FASER DETECTOR

The detector consists of:

- Scintillator veto
- 1.5m long decay volume
- 2m long spectrometer
- EM calorimeter

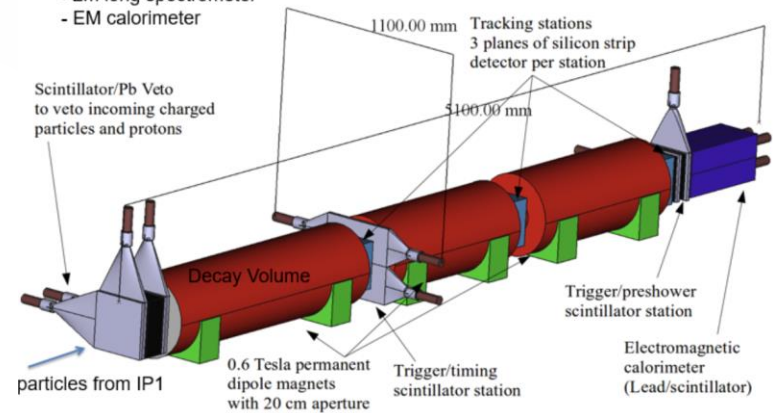

EXPECTED SENSITIVITY

- Sensitivity for dark photons
 - Assuming no background and 100% signal efficiency
 - Curves only slightly effected by $O(1)$ changes in efficiency

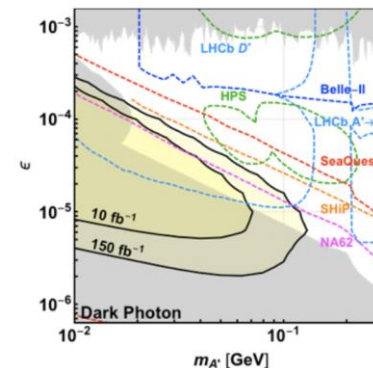

Even with 10/fb (to be collected by end of 2021?) have sensitivity to uncharted territory. With full Run 3 dataset (150/fb) significant discovery potential.

FASER Phase 2

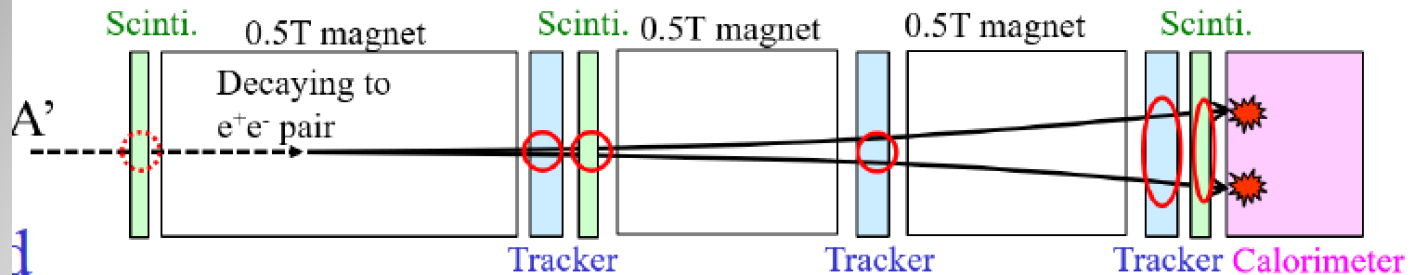

- FASER2 is a potential upgrade to run in HL-LHC with bigger dimensions of the detector.

- Radius: 1 m
- Decay volume length: 5 m

For the HL-LHC run..

- FASER2 can explore much larger parameter space in dark sectors.

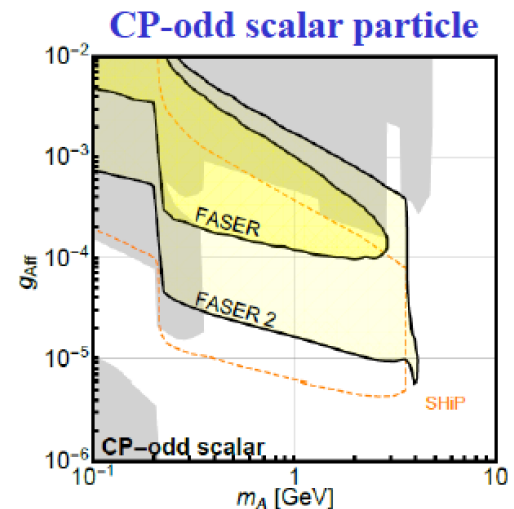
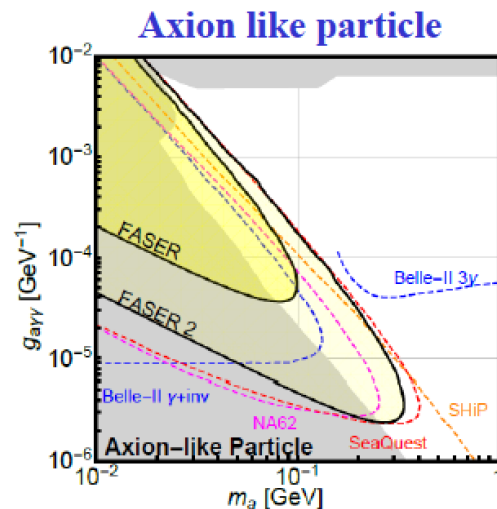
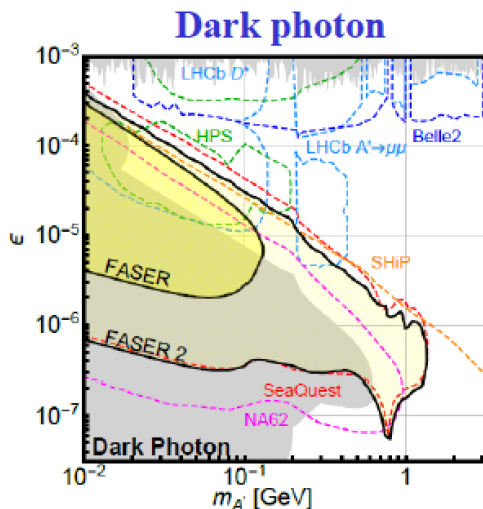

Status of the Various Projects

Simon Knapen FNAL seminar fall 2018

Lifetime frontier

Supplementary detectors

	Higgs decay	B-meson decay	π, η -decay (dark photon)	Progress	Cost
FASER		✓	✓	Collaboration formed	\$
CODEX-b	✓	✓		sub-collaboration formed	\$
SeaQuest			✓	experiment exists	\$
AL3X	✓	✓	✓	Proof of concept	\$\$
MATHUSLA	✓	(✓)		Letter of intent	\$\$
SHiP		✓	✓	Technical design report	\$\$\$

MOEDAL: monopoles, already running

MiliQan: milicharged particles, phase 1 detector in place

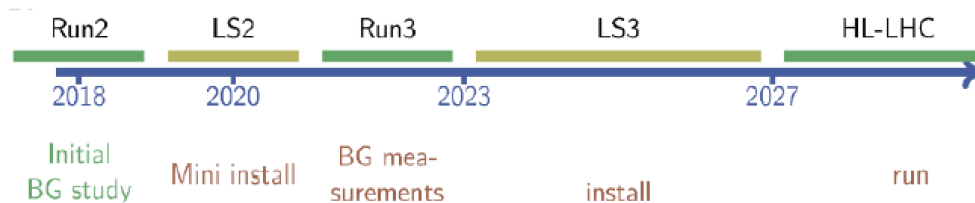

Similar timelines for MATHUSLA, MilliQan CODEX-b, FASER

LHC Future Running till ~2037

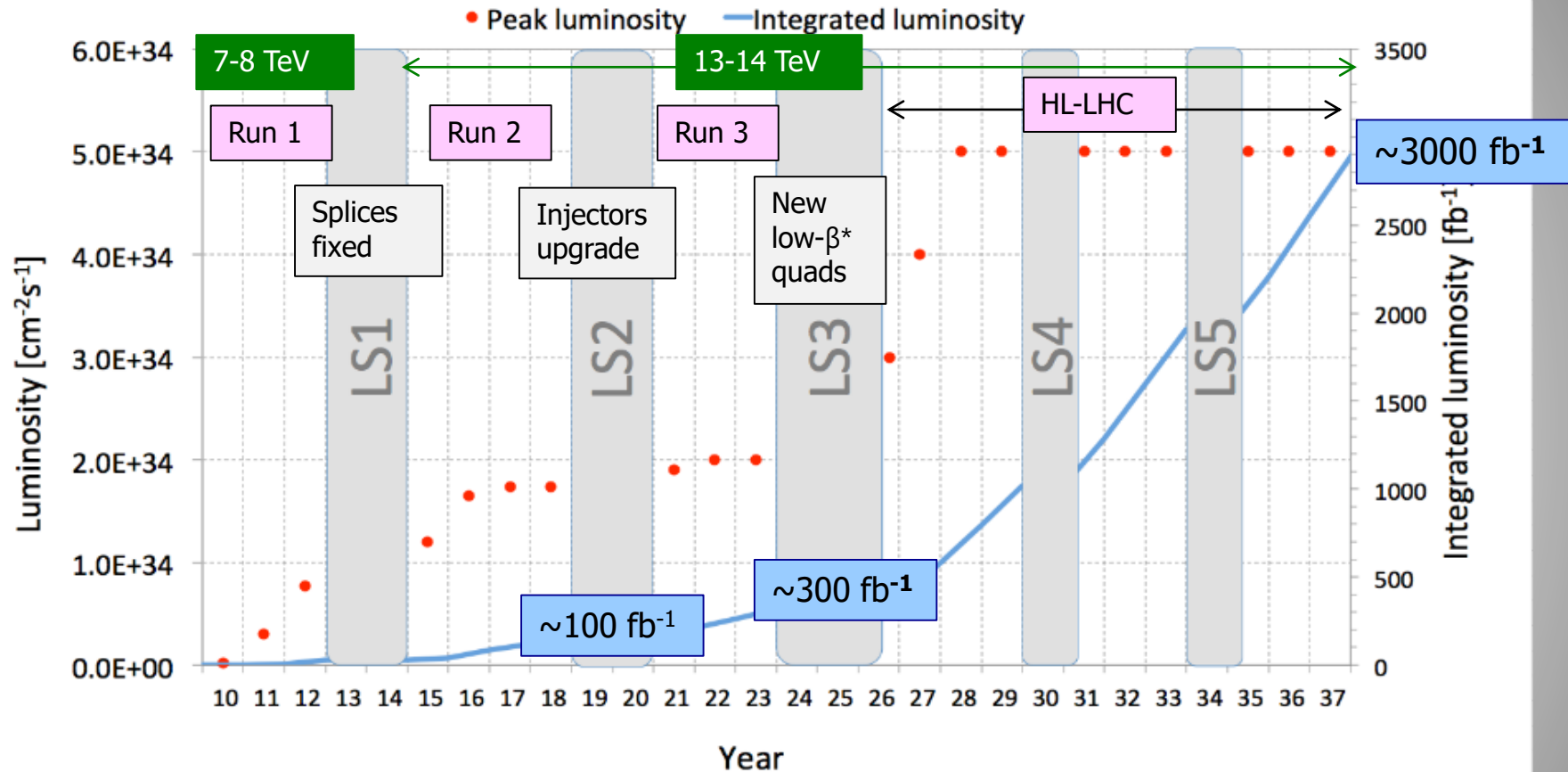

Approved program at CERN to collect 3-4 ab^{-1} with the LHC (HL-LHC)
Maximize the reach for searches and for precision measurements (eg Higgs)

CERN High Beam Intensity Initiative



11

Status and Prospects of PHYSICS BEYOND COLLIDERS at CERN

Study Group mandated by the CERN Management
to prepare the next European HEP strategy update (2019-20)
(coordination: J. Jäckel, M. Lamont, C.V.)

Excerpt from the mandate:

*“Explore the opportunities offered by the CERN accelerator complex
to address some of today’s outstanding questions in particle physics
through experiments complementary to high-energy colliders
and other initiatives in the world.”*

Time scale: next 2 decades

Physics Beyond Colliders at CERN

1

Many studies on
long lived particles

Summary plots of the
reach are being completed
for the European Strategy
Document (November)

Last workshop (January '19)
<https://indico.cern.ch/event/755856/>

Next workshop November 5-6



NA62, NA64, SHIP, LHC new experiments...

New Possible Experiments

From the beyond collider study document: [arXiv:1902.00260](https://arxiv.org/abs/1902.00260)

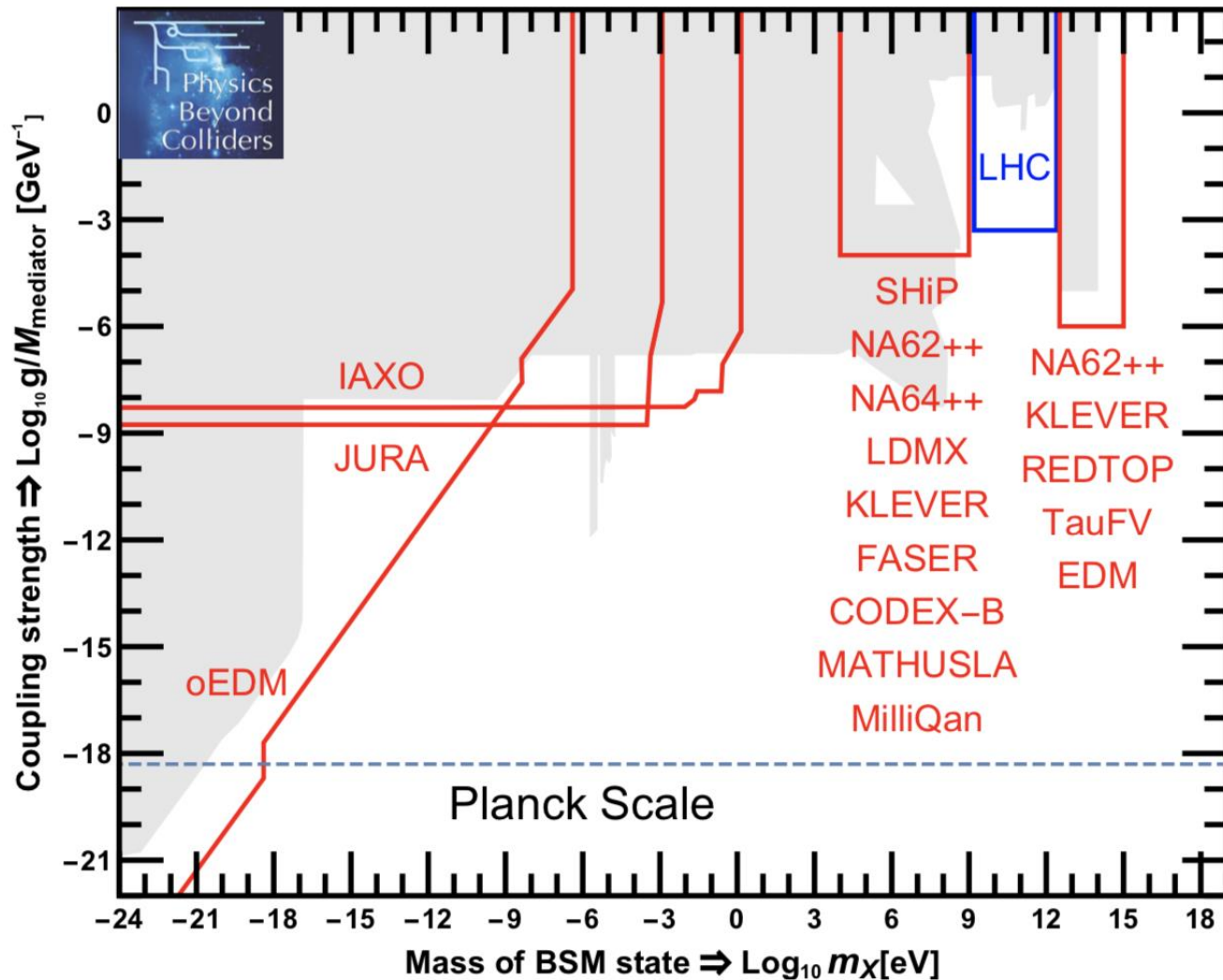

SHiP Beam Dump Experiment Proposal

SHiP is a proposed intensity-frontier experiment aiming to search for neutral hidden particles with mass up to $O(10)$ GeV and weak couplings, down to 10^{-10} .

arXiv:1504.04956

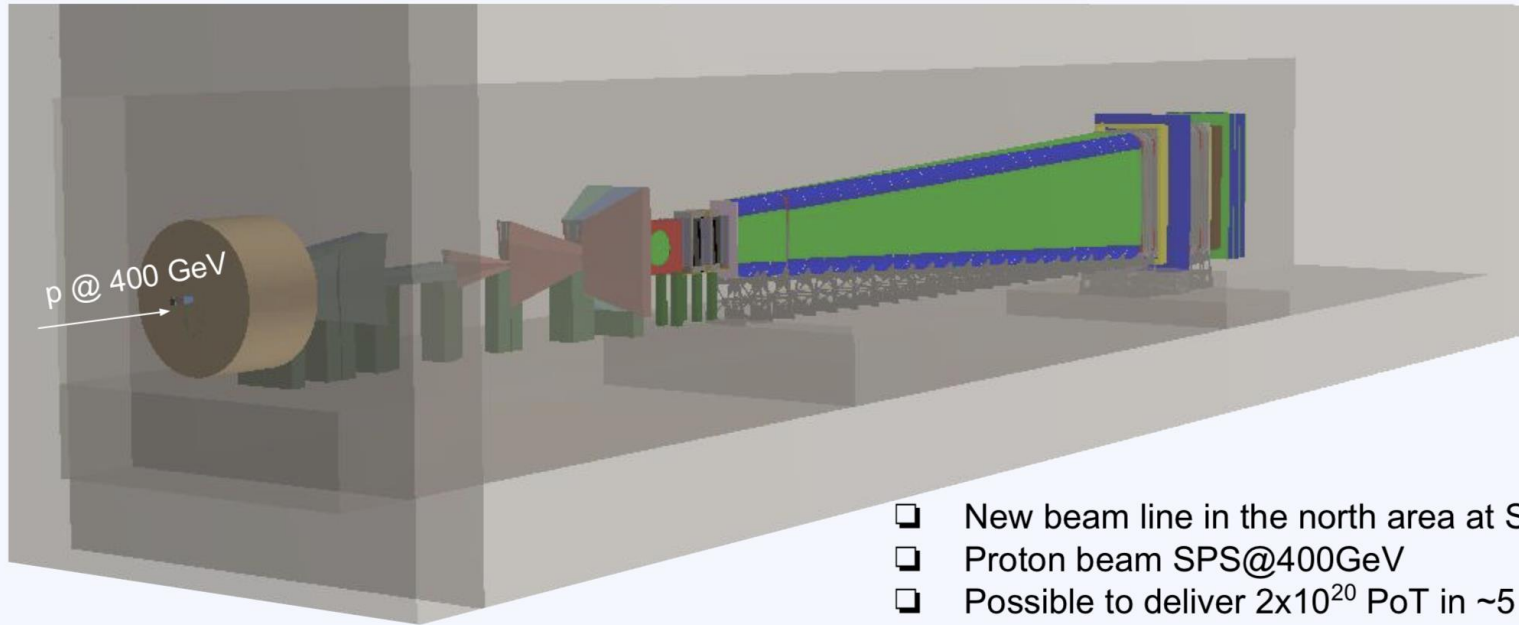

- ❑ New beam line in the north area at SPS
- ❑ Proton beam SPS@400GeV
- ❑ Possible to deliver 2×10^{20} PoT in ~5 years

arXiv:1811.00930

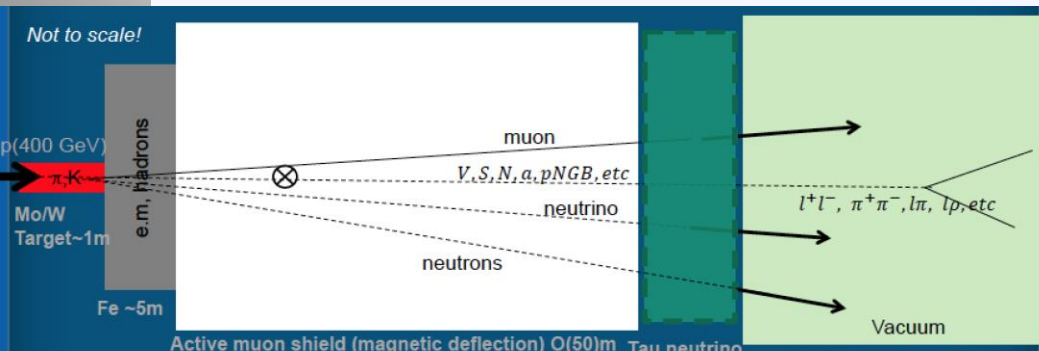
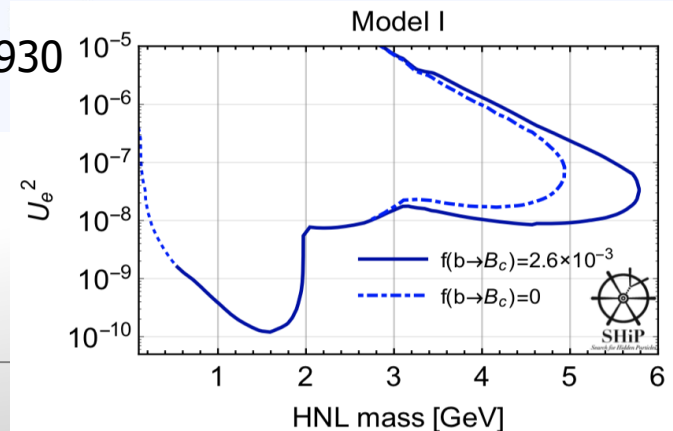

Neutrino Detector & Program

Note: anti- ν_τ has never been observed

SHiP neutrino program
 $\sim 8k$ expected ν_τ and $\sim 4k$ anti- ν_τ interactions in the target

- First observation of anti- ν_τ
- Sufficient statistics to perform ν_τ and anti- ν_τ cross section measurement.
- First measurement of structure function F_4 and F_5 entering in DIS neutrino-nucleon cross section

Follows the OPERA concept

Implementation in dedicated CERN framework (FairSHIP)

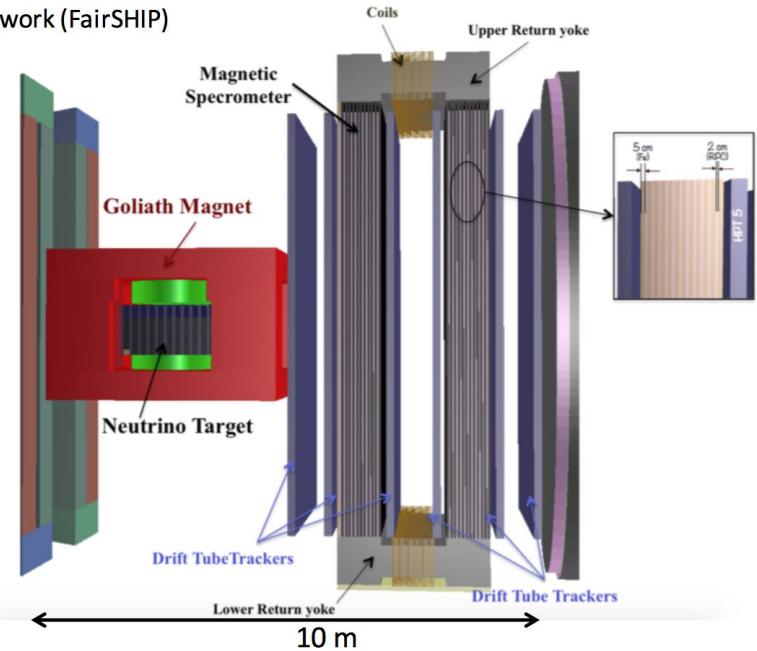

	$\langle E \rangle$ (GeV)	Interactions
N_{ν_e}	46	2.5×10^5
N_{ν_μ}	29	1.7×10^6
N_{ν_τ}	59	7.4×10^3
$N_{\bar{\nu}_e}$	46	9.0×10^4
$N_{\bar{\nu}_\mu}$	28	6.7×10^5
$N_{\bar{\nu}_\tau}$	58	3.7×10^3

Neutrino interactions for 5 year running

Sensitivity Summaries

Search for dark photons (visible mode)

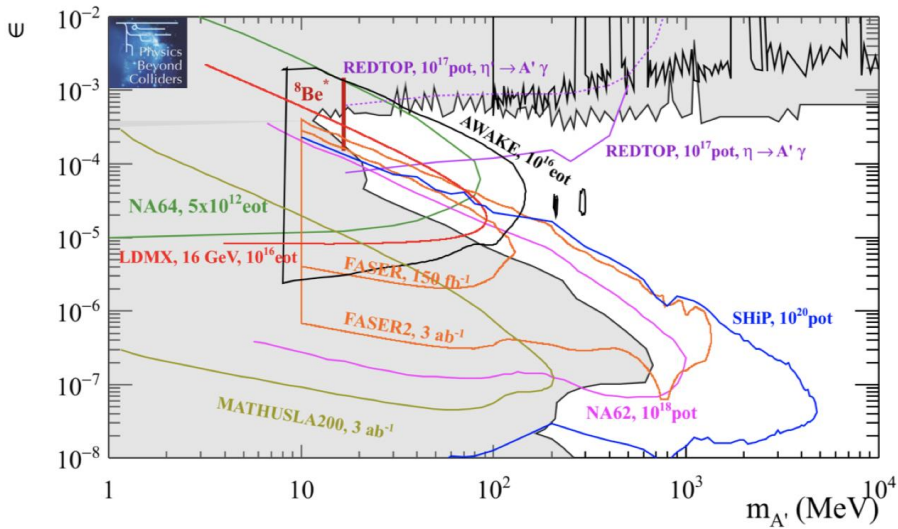

Search for millicharges

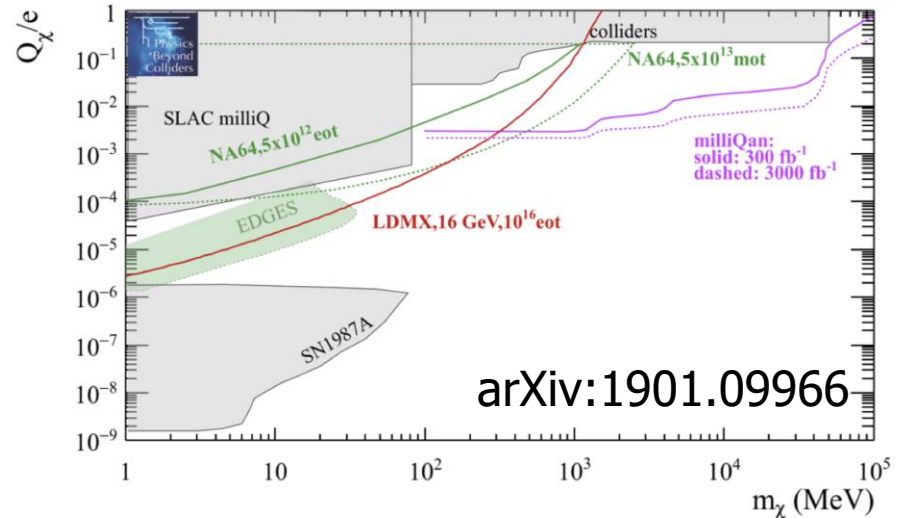

Search for dark scalars

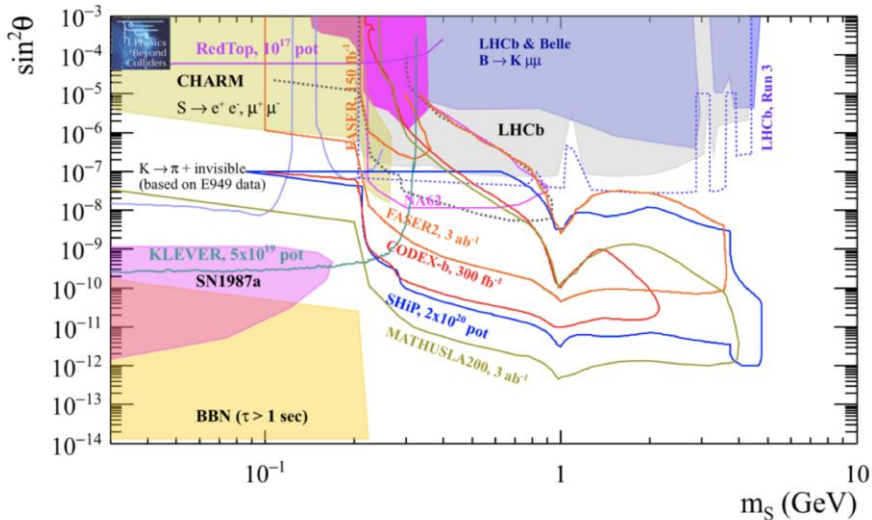

Search for heavy neutral leptons

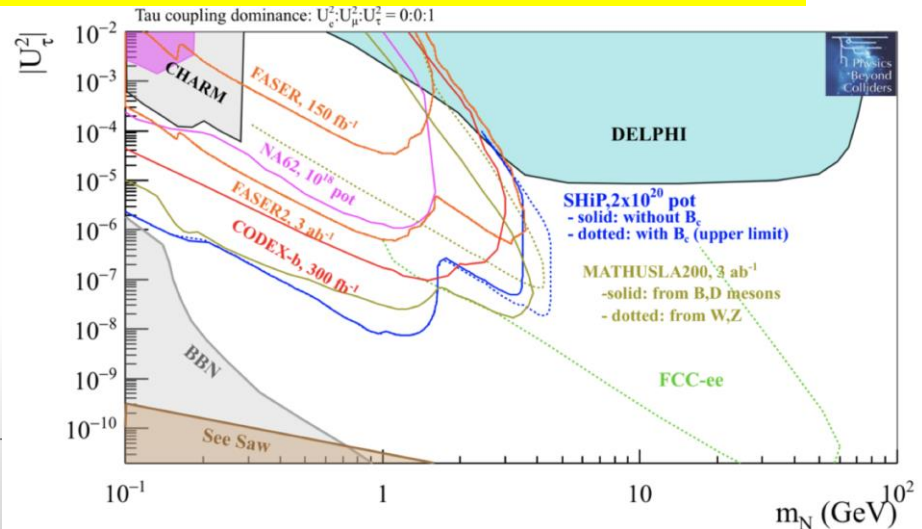

Beam Dump Experiments

High intensity frontier for low mass particles with very weak couplings

-> upcoming neutrino experiments (SBL, LBL) foresee very high intensity beams

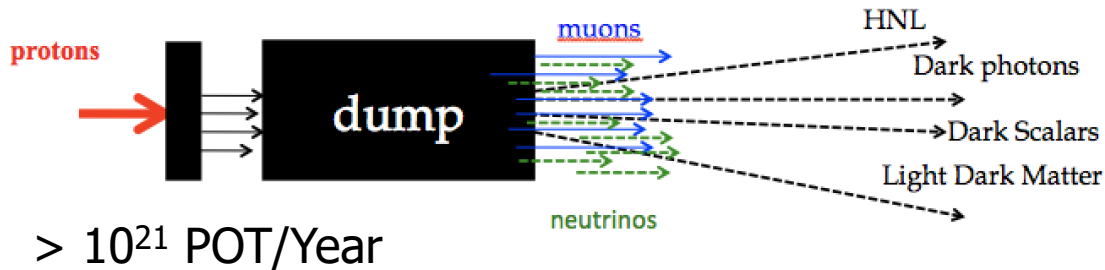

Near Detector:
few 100m away
from the dump

<https://indico.fnal.gov/event/18430/>

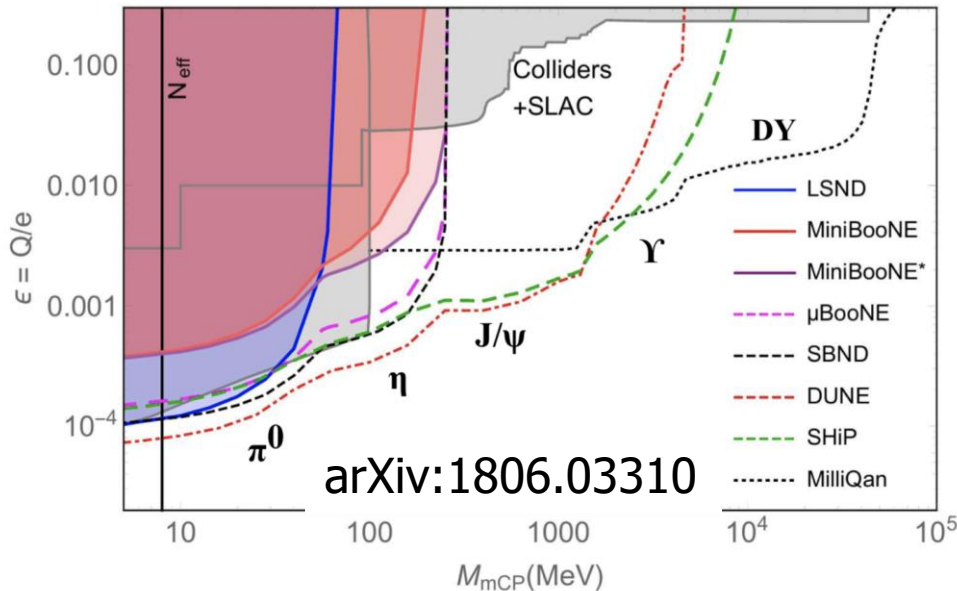

These experiments can perform searches for low mass New Physics particles eg

- HNL/sterile neutrinos
- dark photons
- ALPs
- mini/millicharges

...

<- Example for millicharges
FerMINI @FNAL?

More Milli-Charge Hunting

A proposal for milli-charges at FNAL @ MINOS near detector
Submitted last week.

FerMINI: Fermilab Search for Milicharged Particle

J. F. Hirschauer, (Principle Investigator) and Y.-D. Tsai (Co-Investigator)

Fermi National Accelerator Laboratory, Batavia, IL 60510, USA

A. Haas (Co-Investigator)

New York University, New York, NY 10003, USA

C. Hill (Co-Investigator)

Ohio State University, Columbus, OH 43210, USA

D. Miller (Co-Investigator)

University of Chicago, Chicago, IL 60637, USA

D. Stuart (Co-Investigator)

University of California, Santa Barbara, CA 93106-9530, USA

See also: arXiv:1806.03310

Based on the MilliQan design

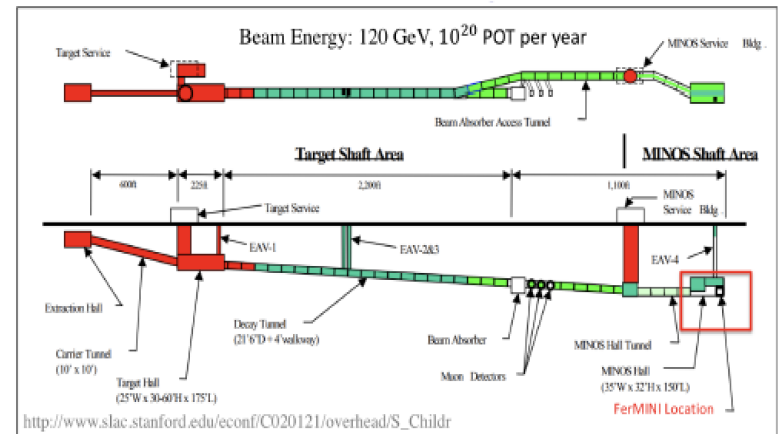
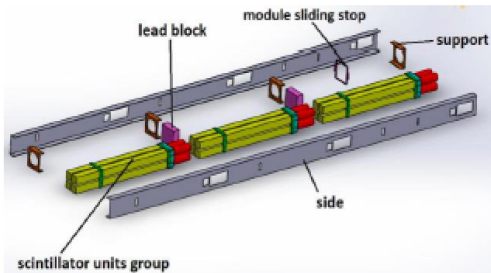
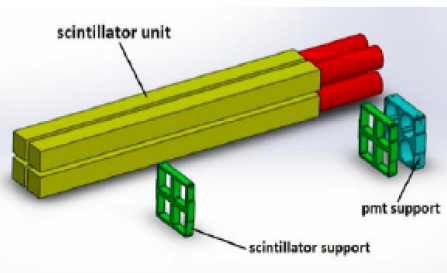
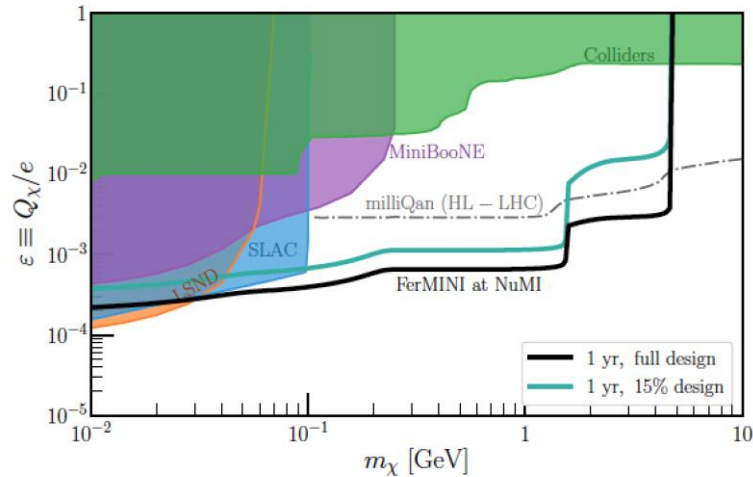

More Milli-Charge Activities

Physics Beyond Collider Study

arXiv:1901.09966

Physics Beyond Colliders at CERN
Beyond the Standard Model Working Group Report

J. Beacham¹, C. Burrage^{2,*}, D. Curtin³, A. De Roeck⁴, J. Evans⁵, J. L. Feng⁶, C. Gatto⁷, S. Gninenko⁸, A. Hartin⁹, I. Irastorza¹⁰, J. Jaeckel¹¹, K. Jungmann^{12,*}, K. Kirch^{13,*}, F. Kling⁶, S. Knapen¹⁴, M. Lamont⁴, G. Lanfranchi^{4,15,*}, C. Lazzaroni¹⁶, A. Lindner¹⁷, F. Martinez-Vidal¹⁸, M. Moulson¹⁵, N. Neri¹⁹, M. Papucci^{4,20}, I. Pedraza²¹, K. Petridis²², M. Pospelov^{23,*}, A. Rozanov^{24,*}, G. Russo^{25,*}, P. Schuster²⁶, Y. Semertzidis²⁷, T. Spadaro¹⁵, C. Vallée²⁴, and G. Wilkinson²⁸.

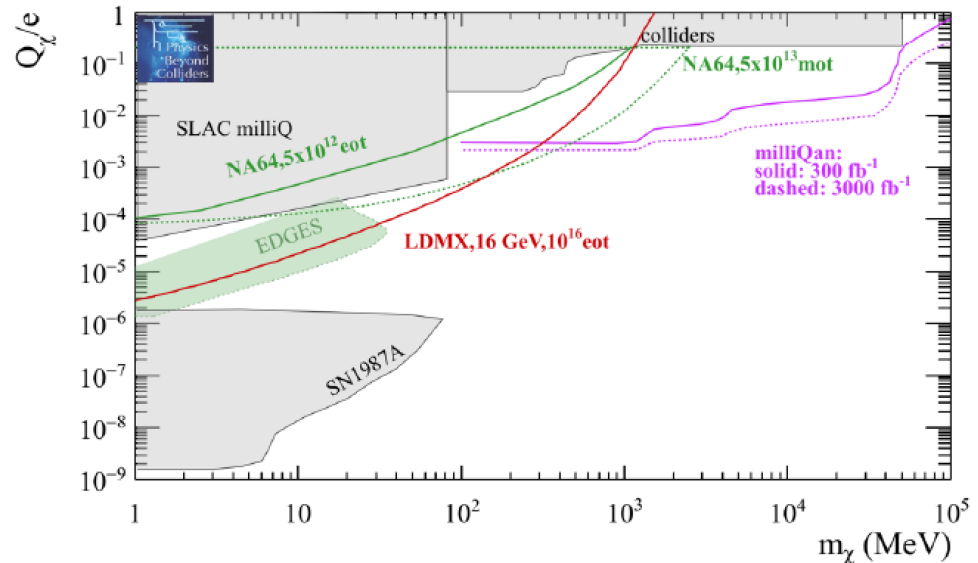

Millicharged Particles in Liquid Argon Neutrino Experiments

Roni Harnik¹, Zhen Liu², and Ornella Palamara¹
¹Fermi National Accelerator Laboratory, Batavia, IL 60510, USA
²Maryland Center for Fundamental Physics,
 Department of Physics, University of Maryland,
 College Park, MD 20742-4111 USA

arXiv:1902.03246

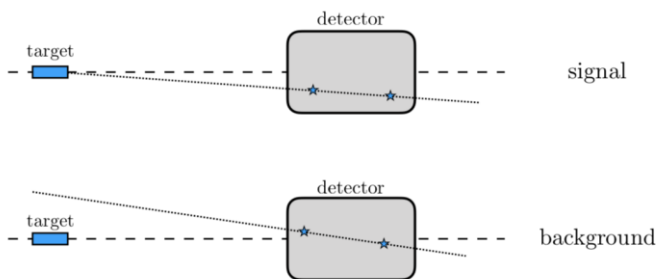

LArTPC study

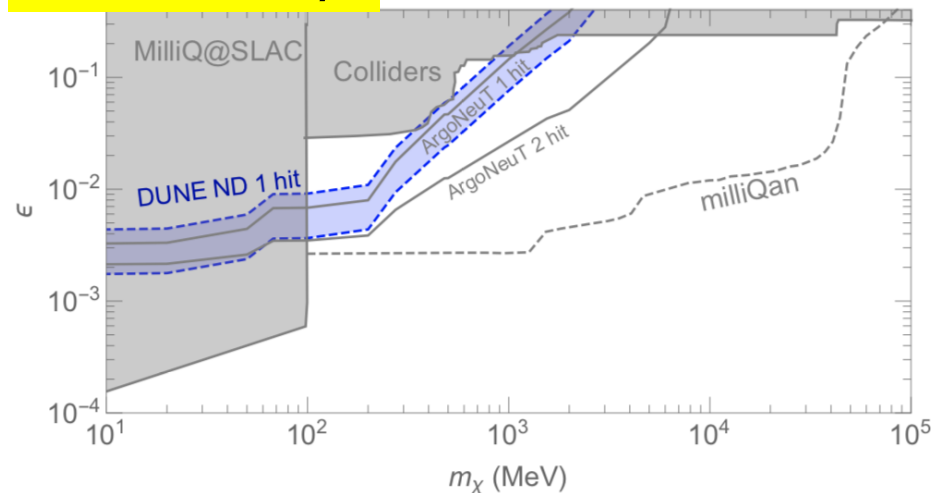

Current Neutral LLP Searches

2016

at the LHC

Exp	Search	run	signal	LLP Daughters	LLP Scale	Parent Scale	Associated Objects	# LLP Decays	decay Location	decay Detector	L1 trigger
CMS	EXO-12-035-pas	8 TeV	GMSB neutralino $\rightarrow \gamma + G$	$\gamma + \text{MET}$	100-300 GeV	$x2 + - 50$	jets, MET	1	tracker	ECAL (timing)	one photon
	EXO-14-017-pas	8 TeV	GMSB neutralino $\rightarrow \gamma + G$	$\gamma + \text{MET}$	200-300 GeV	$x2 + - 50$	MET	2	tracker	tracker (conversion)	diphoton
	1211.2472	7 TeV	$H \rightarrow XX$	2 leptons	20+ GeV	100+ GeV	none	2	tracker	same	dilepton
	1411.6530v2	8 TeV	$H \rightarrow XX$, RPV SUSY	2 jets	50+ GeV	200+ GeV	none or jets	1	tracker	same	HT > 300 GeV
	1411.6977	8 TeV	$H \rightarrow XX$, RPV SUSY	2 leptons	20+ GeV	100+ GeV	none	1	tracker	same	dilepton
	1409.4789	8 TeV	RPV SUSY	e and mu	0.5 - 1 TeV	$x2$	none	2	tracker	tracker, MS	one muon
ATLAS	1504.03634	8 TeV	$H \rightarrow XX$, HV Z', Stealth SUSY	2x - anything	10+ GeV	100+ GeV	none	2	Muon System	same	Muon Rol
	1501.04020	8 TeV	$H \rightarrow XX$	2x - anything	10+ GeV	100+ GeV	none	2	HCAL	same	CalRatio
	1409.0746	8 TeV	$H \rightarrow HV \dots \rightarrow XX$	2 leptons	0.4 - 2 GeV	~ 100 GeV	none	2	tracker	same	standard lepton(s)
	1504.05162	8 TeV	SUSY (split, rpv, gmsb)	2 leptons or 5+ charges	10+ GeV	600+ GeV	various		tracker	same	HARD MET, Jet, lepton
		7tev							0.4-4.8mm		single track > 1.5 - 3.5 GeV
LHCb	1412.3021	0.62/fb	$H \rightarrow XX$	2 quarks	25 - 50 GeV	100 GeV	none	1	From beam	tracker	single track > 1.5 - 3.5 GeV

not yet

Need a more systematic approach

more like



Shorter lifetimes: identify DV for $< \sim \text{mm}$ displacements

Mass gaps in current searches:

- $X \rightarrow$ leptons: 2 - 20 GeV
- $X \rightarrow$ hadrons: < 10 GeV

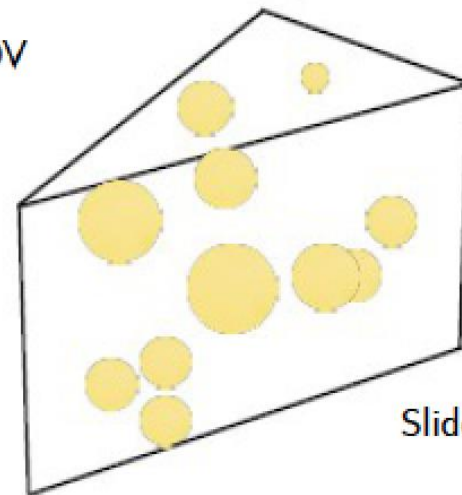

Slide from D. Curtin

LHC Community White Paper

Web page: <https://indico.cern.ch/event/649760>

Searches for long-lived particles at the LHC: Second workshop of the LHC LLP Community

17 Oct 2017, 16:00 → 20 Oct 2017, 18:00 Europe/Zurich

Giambiasi Lecture Hall (ICTP, Trieste, Italy)

Albert De Roeck (CERN), Bobby Samir Acharya (Abdus Salam Int. Cent. Theor. Phys. (IT)), Brian Shuve (SLAC National Accelerator Laboratory), James Beacham (Ohio State University (US)), Xabier Cid Vidal (Universidade de Santiago de Compostela)

Recent workshop: 27-29 May 2019 CERN

White paper — chapter statuses and roundtable
[draft [here](#) (18 Oct)]

- Simplified models — **First draft done!**
- Experimental coverage — **First draft essentially done!**
- Triggers, upgrades, HL- / HE-LHC opportunities
— **First draft in progress**
—> discussion today [live doc!]
- Re-interpretations / recommendations
— **First draft imminent!**
- Backgrounds — **First draft imminent!**
- Dark showers
— **First draft (summarizing status and advertising for the future) imminent!**



Searches for long-lived particles at the LHC:
Second workshop of the LHC LLP Community
17-20 October 2017



ICTP 2017

ICTP
The Abdus Salam
International Centre
for Theoretical Physics

White Paper being finalized

Input from ATLAS, CMS,
LHCb, proposed specialized
experiments and theory
Completed March 2019
(~ 300 pages)

Also meetings with
LHC Dark Matter group

Recent Reviews/Reports

arXiv.org > hep-ex > arXiv:1903.04497

High Energy Physics – Experiment

Searching for long-lived particles beyond the Standard Model at the Large Hadron Collider

White paper of the LHC long-lived particle community

Report of the CERN Physics Beyond Colliders Working group

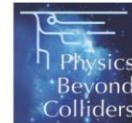

CERN-PBC-REPORT-2018

arXiv.org > hep-ex > arXiv:1902.00260

Summary Report of Physics Beyond Colliders at CERN

*R. Alemany¹, C. Burrage², H. Bartosik¹, J. Bernhard¹, J. Boyd¹, M. Brugger¹, M. Calviani¹, C. Carli¹, N. Charitonidis¹, D. Curtin²³, A. Dainese³⁴, A. de Roeck¹, M. Diehl³, B. Döbrich¹, L. Evans¹, J.L. Feng²⁴, M. Ferro-Luzzi¹, L. Gatignon¹, S. Gilardoni¹, S. Gninenko¹⁹, G. Graziani³², E. Gschwendtner¹, B. Goddard¹, A. Hartin¹⁶, I. Irastorza²⁰, J. Jaeckel^{*4}, R. Jacobsson¹, K. Jungmann⁵, K. Kirch⁶, F. Kling²⁴, W. Krasny¹³, M. Lamont^{*1}, G. Lanfranchi⁷, J-P. Lansberg²⁷, A. Lindner³, K. Long¹², A. Magnon¹, G. Mallot¹, F. Martin Vidal²¹, M. Moulson⁷, M. Papucci¹, J. M. Pawlowski⁴, I. Pedraza²⁵, K. Petridis¹⁸, M. Pospelov⁸, S. Pulawski³¹, S. Redaelli¹, S. Rozanov⁹, G. Rumolo¹, G. Russo¹⁰, J. Schache¹, G. Schnell¹¹, P. Schuster²², Y. Semertzidis¹⁴, A. Siemko¹, T. Spadaro⁷, S. Stapnes¹, A. Stocchi¹, H. Ströher¹⁵, G. Usai³⁰, C. Vallée^{*9}, G. Venanzoni²⁶, G. Wilkinson³³, and M. Wing¹⁶*

Collider Searches for Long-Lived Particles
Beyond the Standard Model

arXiv.org > hep-ph > arXiv:1810.12602

Lawrence Lee¹, Christian Ohm^{2,3}, Abner Soffer⁴, Tien-Tien Yu^{5,6}

Present LHC coverage paper

Summary

- Clearly and increased interest in LLP searches at the LHC in CMS, ATLAS, LHCb, MoEDAL. Many analyses done or in are progress. No signal observed yet, but only top of the iceberg covered so far.
- LLP White Paper released! (LHC). Many ideas for new analyses yet to be analysed for the LHC data
- New ideas for additional small experiments at the LHC to increase the coverage: MilliQan, MAPP, MATHUSLA, CODEX-b, FASER, AL3X. Future beam dump experiments (SHiP). LLPs also focus in the Physics Beyond Collider studies
- Of interest to study in detail the complementarity with LLP searches at Neutrino Near Detectors. Can these be further optimized?
- More opportunities at future projects (FCC...)->J. Beacham

Physics Goals

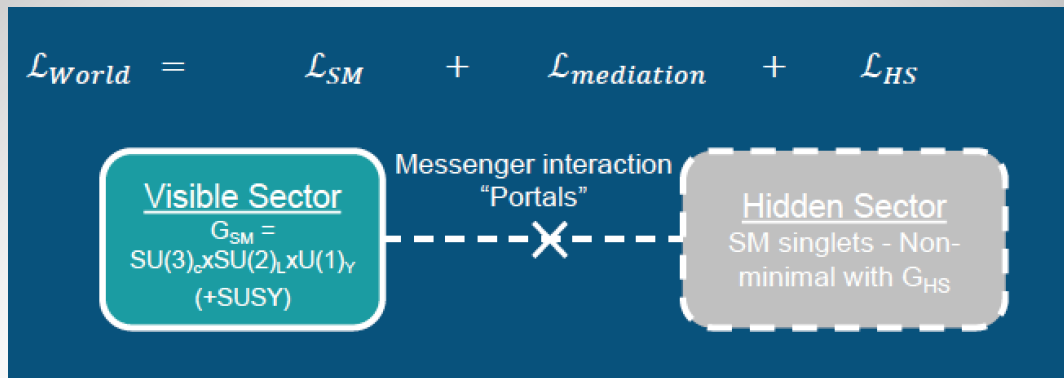

New physics prospects in the hidden sector

Explore Hidden Portals and extensions of the Standard Model incorporating long lived and very weakly interacting particles

- **Vector portals:** motivated by 'mirror world', constituting dark matter, g-2 anom.
- **Scalar portals:** right handed neutrinos, dark matter, inflation, "dark naturalness"
- **Neutrino portals:** neutrino oscillations, dark matter, baryon asymmetry...
- **Axion portals:** extended Higgs, SUSY breaking, dark matter, inflation...
- **SUSY portals...**

Two search methods:

1. "Indirect detection" through portals in (missing mass)
2. "Direct detection" through both portals in and out

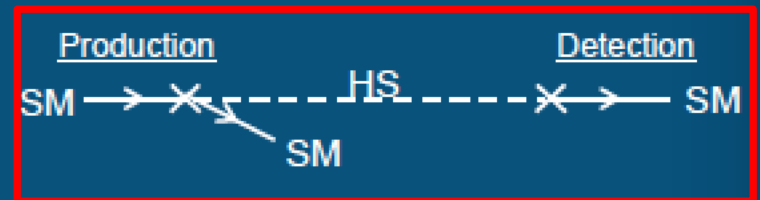

Details on the Portals

- **D = 2: Vector portal**

- Kinetic mixing with massive dark/secluded/paraphoton $V: \frac{1}{2} \epsilon F_{\mu\nu}^{SM} F_{HS}^{\mu\nu}$

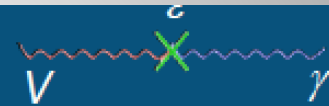

- Motivated in part by idea of “mirror world” restoring left and right symmetry, constituting dark matter, g-2 anomaly, ...
- Production: proton bremsstrahlung, direct QCD production $q\bar{q} \rightarrow V, qg \rightarrow Vq$, meson decays ($\pi^0, \eta, \omega, \eta', \dots$)

- **D = 2: Scalar portal**

- Mass mixing with dark singlet scalar $\chi: (gS + \lambda S^2)H^\dagger H$

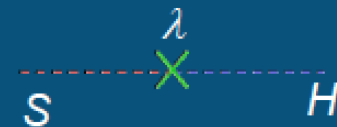

- Mass to Higgs boson and right-handed neutrino, inflaton, dark phase transitions BAU, dark matter, “dark naturalness”,
- Production: Direct $p + target \rightarrow X + S$, meson decays e.g. $B \rightarrow KS, K \rightarrow \pi S$

- **D = 5/2: Neutrino portal**

- Mixing with right-handed neutrino N (Heavy Neutral Lepton): $Y_{I\ell} H^\dagger \bar{N}_I L_\ell$

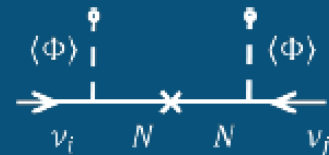

- Neutrino oscillation, baryon asymmetry, dark matter

- Production: Leptonic, semi-leptonic decays of heavy hadrons

- **D = 4: Axion portal**

- Mixing with Axion Like Particles, pseudo-scalars pNGB, axial vectors $a: \frac{a}{F} G_{\mu\nu} \tilde{G}^{\mu\nu}, \frac{\partial_\mu a}{F} \bar{\psi} \gamma_\mu \gamma_5 \psi$, etc

- Generically light pseudo-scalars arise in spontaneous breaking of approximate symmetries at a high mass scale F

- Extended Higgs, SUSY breaking, dark matter, possibility of inflaton, ...

- Production: Primakoff production, mixing with pions and heavy meson decays

- **And higher dimensional operator portals**

- Chern-Simons portal (vector portal)