



**The Abdus Salam  
International Centre for Theoretical Physics**



**2166-Handout**

**College on Medical Physics. Digital Imaging Science and Technology to  
Enhance Healthcare in the Developing Countries**

*13 September - 1 October, 2010*

**Basis of Computed Radiography & PACS**

Slavik Tabakov  
*King's College London  
United Kingdom*

# Basis of Computed Radiography & PACS

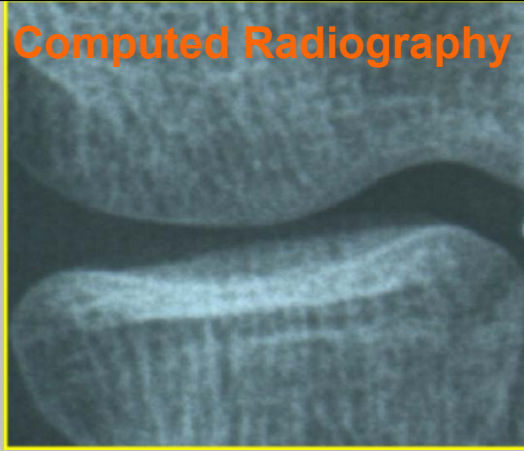

Slavik Tabakov

slavik.tabakov@emerald2.co.uk

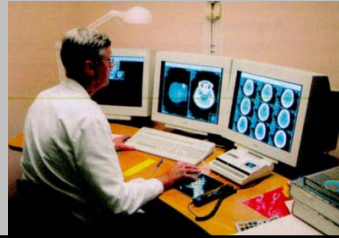

## Digital



## Film-screen

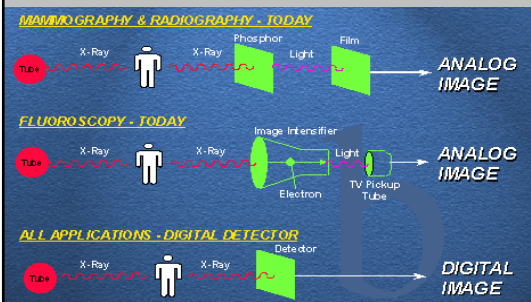
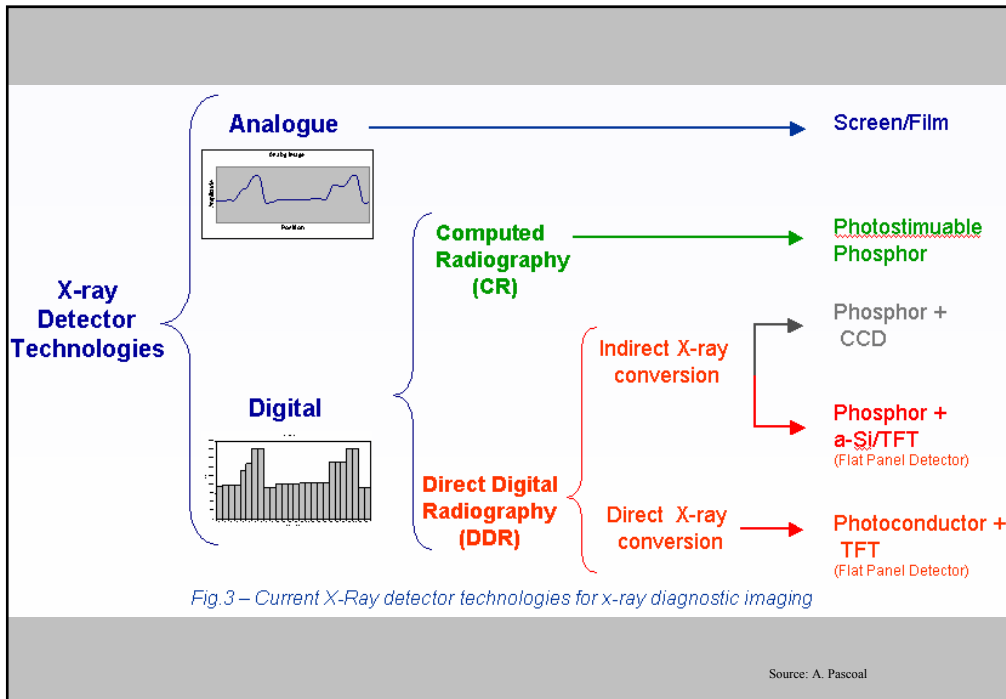

Image comparison and image transfer through various systems



**CR system** using laser stimulated **storage phosphor screens**

*Very similar radiographic usage:*  
**X-tube > patient > cassette > Reader > re-use**

ADC 70

Ortho

3M

b)

## Photo-stimulated luminescence mechanism

The storage phosphor, usually made from  $BaFX:Eu^{2+}$  ( $X=Cl, Br, I$ ) is contained within a cassette, similar in appearance to those used in film-screen radiography.

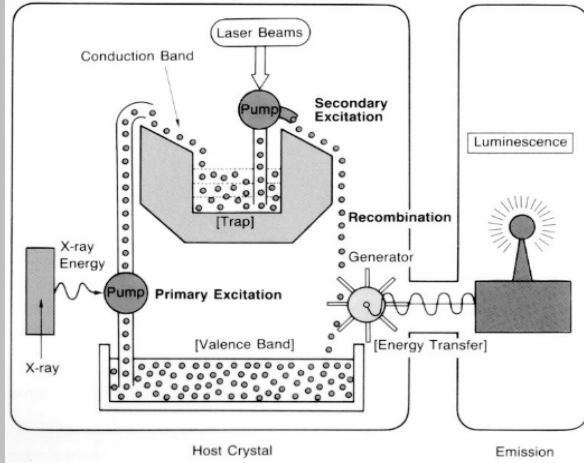
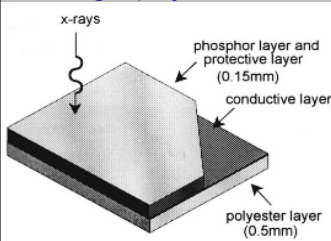

$Eu^{2+} \gg x\text{-ray} \gg Eu^{3+} + \text{free } e$   
 $\text{free } e \gg \text{into bromine energy traps}$   
 $Eu^{3+} + \text{free } e \gg \text{IR laser} \gg Eu^{2+} + \text{PSL (390 nm)}$

He-Ne laser stimulus infra-red (632 nm)  
 Eu characteristic radiation (PSL) – 390 nm (ultra-violet)  
 Fast scanning (PSL~0.8 ms)

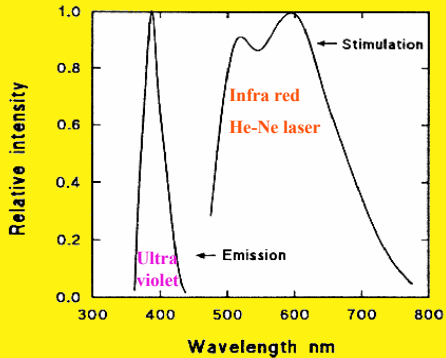
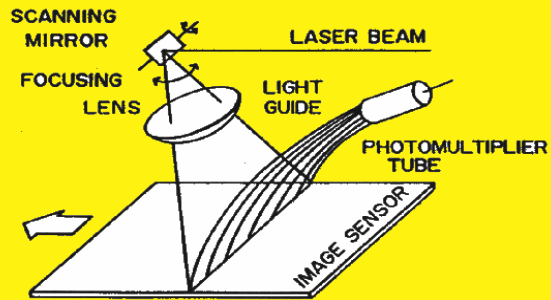

Commercial plates matrix:  
 1760x2140 (standard resolution):  
 2000X2510 (high resolution)  
 Resolution ~ 3 - 5 lp/mm (12 bits)



### Storage-Phosphor (CR) against Film-Screen

- Much higher dynamics of CR (1:10000)
- Virtually no bad CR exposures (repetition)
- Very good contrast of CR
- Image processing in CR plus edge enhance
- Digital storage and retrieval of CR images
- Patient dose reduction
- Radiographic techniques preserved
- Film still with better resolution (mammo)
- Often CR images printed with laser imager

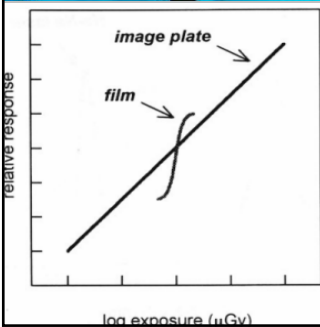

The wide dynamic range of CR systems is an advantage, but could easily lead to overexposure of patient

Optimization of CR procedures !

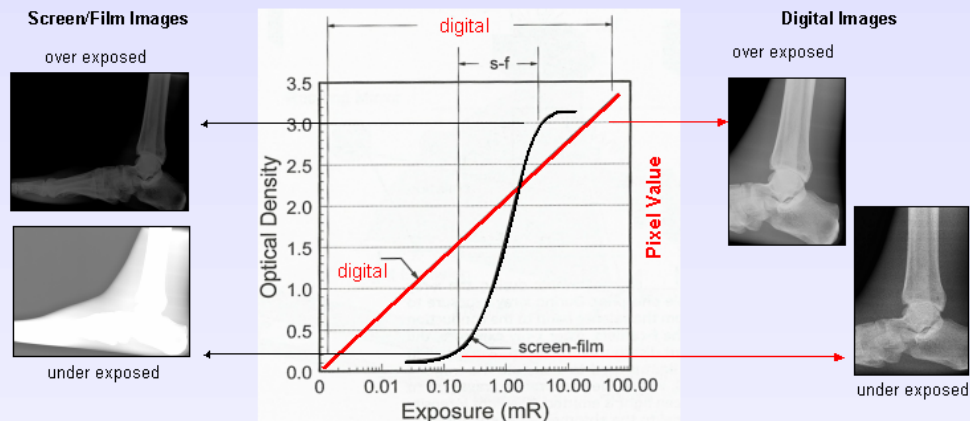

Source: A. Pascoal

The simplest definition of detective quantum efficiency can be stated in the formula. It shows that the DQE is the ratio of the output SNR squared to the input SNR squared.

$$DQE = \frac{SNR_{OUT}^2}{SNR_{IN}^2}$$

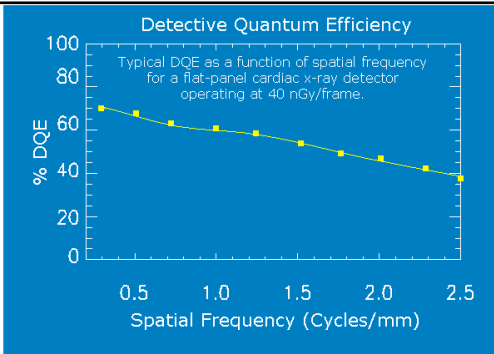

$$DQE_{PSP} = \frac{X_{abs}}{[1 + CV(E)][1 + CV(e)] [1 + CV(S)] + \langle g \rangle^{-1}}$$

where:  $X_{abs}$  = fraction of incident x-ray photons absorbed in the phosphor layer  
 $CV(E)$  = coefficient of variation of the x-ray energy absorbed in the phosphor layer  
 $CV(e)$  = coefficient of variation in the number of trapped electrons for a given absorbed energy  
 $CV(S)$  = coefficient of variation of the light signal emerging from the phosphor for a given number of trapped electrons  
 $\langle g \rangle$  = the average number of photoelectrons detected per absorbed x-ray

## DIGITAL Radiography (DDR) – Flat Panel Detector (FPD)

→ Indirect Conversion

Detector: Scintillator + a-Si diode (ex: **CsI**)  
 Readout: Thin-Film-Transistor

→ Direct Conversion

Detector: Photoconductor (ex: **a-Se**)  
 Readout: Thin-Film-Transistor

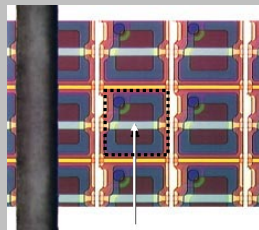

hair  
 pixel  
 (0.10-0.20 mm)

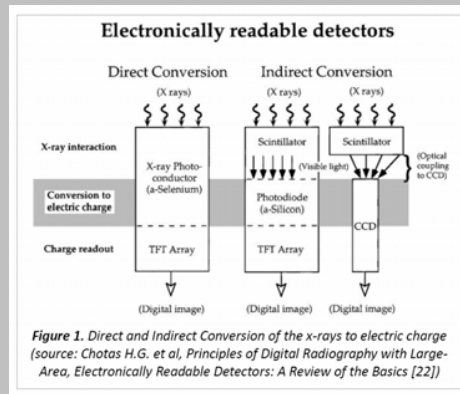

**Digital Radiography with Flat Panel Detectors**

**INDIRECT**

(a-Si diode – only for the electronics)

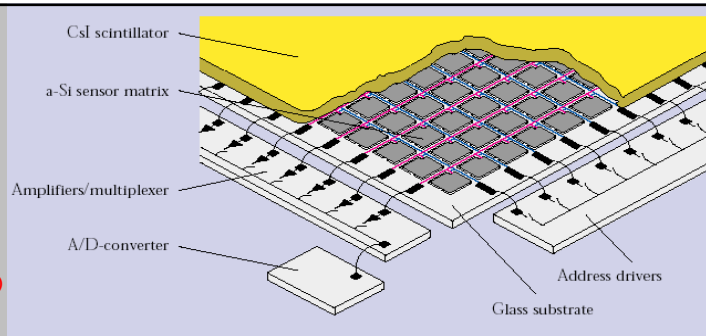

The X-ray sensitive converter is normally the needle-shaped CsI phosphor (used also in Image Intensifiers).

The light is detected by a matrix with array of sensors (a-Silicone diodes), each with own switching element – the readout is line-by-line (through address drivers), followed by amplification and A/D converter.

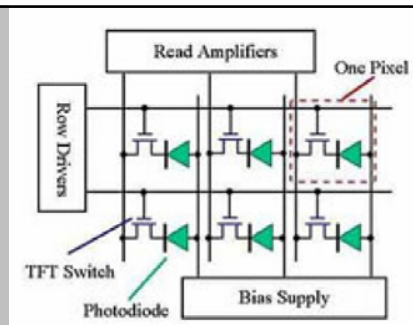
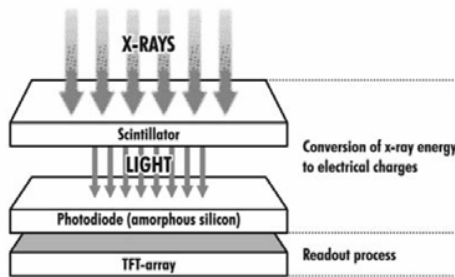
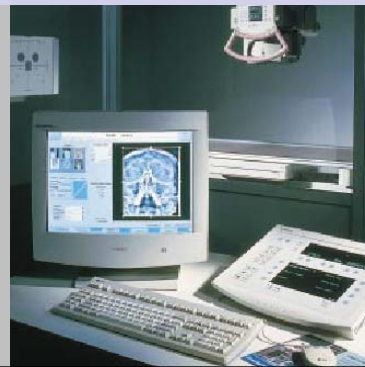

Indirect detector principle; sensitivity and spatial resolution of phosphor

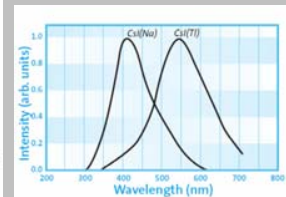
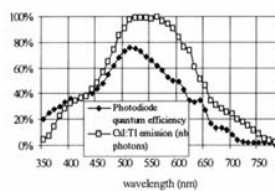
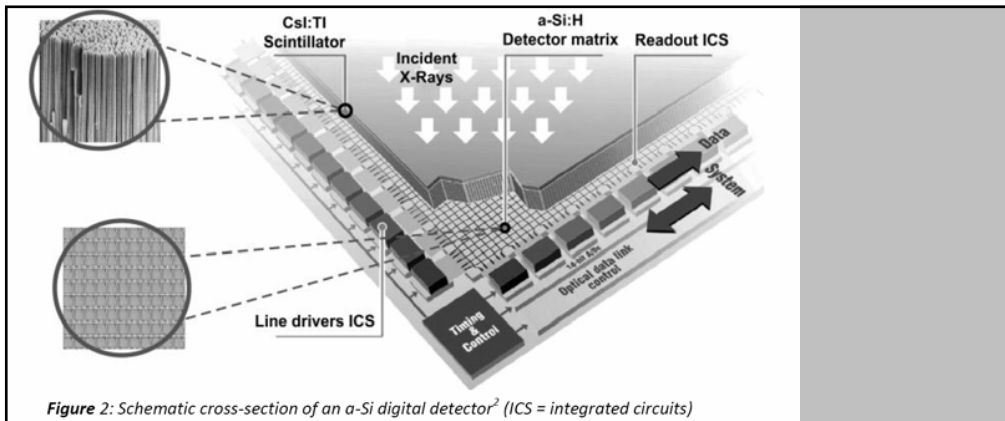

Figure 5: (a) Spectral emission of the CsI:TI crystal matches the spectral response of a-Si:H photodiodes using in x-ray indirect detection systems [9]. (b) electron micrograph of the needle shaped CsI:TI scintillation crystal [10].



**Indirect detector – (CsI Phosphor + Si Detector)**

- Spatial resolution depends on pixel size and phosphor blur
- Due to the blur (slight) the influence of high freq. signals is reduced (hence less noise) and better contrast
- best DQE for all Digital detectors

Detector size 43x43 cm, matrix 3000x3000 (pixel size 0.14 mm) > Resolution >3 Lp/mm  
 DQE ~ 60% (twice the conventional film/screen)  
 Allows integration with Bucky table (anti-scatter)  
 Very high workflow (patient flow)  
 Still quite heavy detector

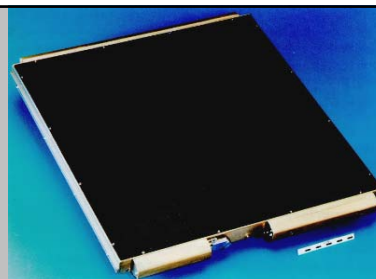

Due to the rapid-sequence imaging, it is expected that in future the flat detector will replace the Image Intensifier TV systems in real-time examinations (fluoroscopy)



2 - Cross section through a flat panel detector. Source: Cowen et al, 2008



Flat Panel Detectors – **DIRECT** (a-Se)

Digital Radiography with **Selenium** Philips Thoravision

Uses amorphous Selenium (similar to xeroradiography)

Direct conversion of X-ray quanta into electrical charge – avoids noise from conversion

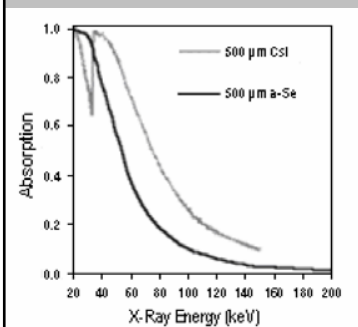
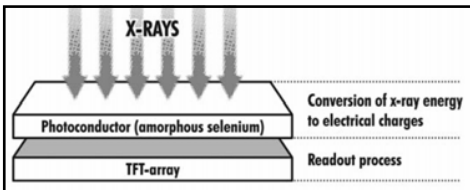
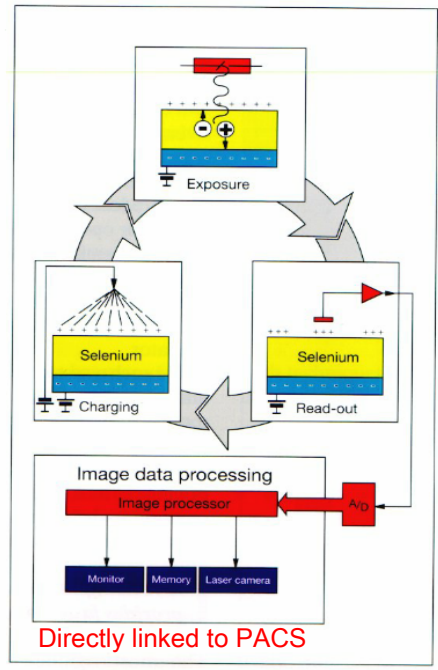
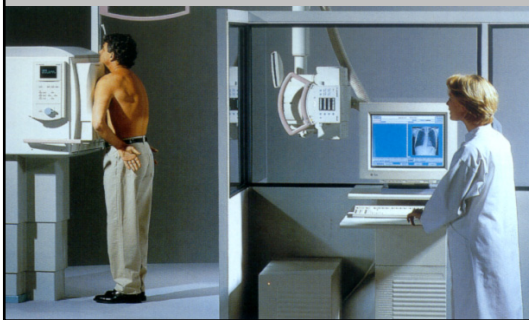

a-Se principle

Capacitors and gates

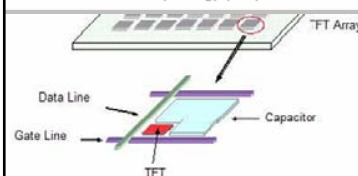

Fill factor

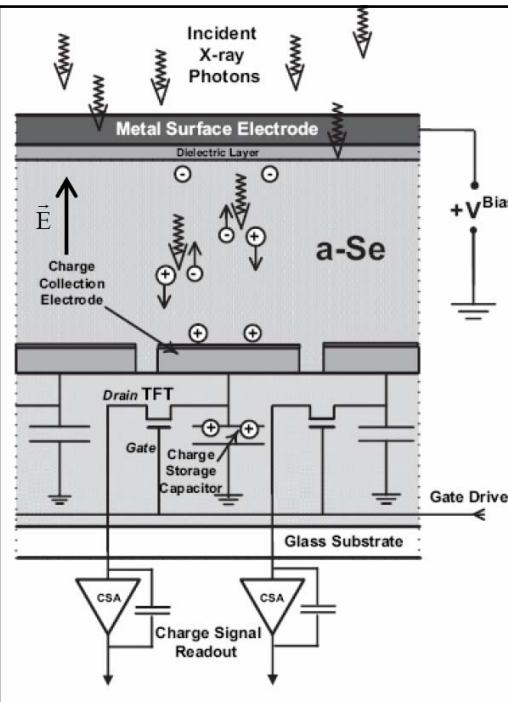

No intermediate light – the signal is transferred through electrical charge.

very good sp. Resolution (less spread)-  
Theoretically up to 20lp/mm for a-Se

but also less absorption in a-Se and hence reduced DQE.

The decrease fo signal leads to reduced Signal/Noise Ratio (and less contrast)

Drum with 50 cm diameter

0.5 mm Selenium (43x49cm)

Read-out array of 36 probes

2000x2000 pixels (each 0.2mm, 14 bits)

Excellent contrast (wide dynamic)

No transport of cassettes (fast radiography)

Directly linked to PACS

## Direct Radiography – FPD overview

→ Direct Conversion (photoconductor + TFT)

\*Thin-Film Transistor

• Indirect Conversion (scintillator + a-Si/TFT)

\*Thin-Film Transistor

# Direct Radiography– CCD

- **Detector:**  
Scintillator
- **Read-out:**  
Charge-Coupled Device

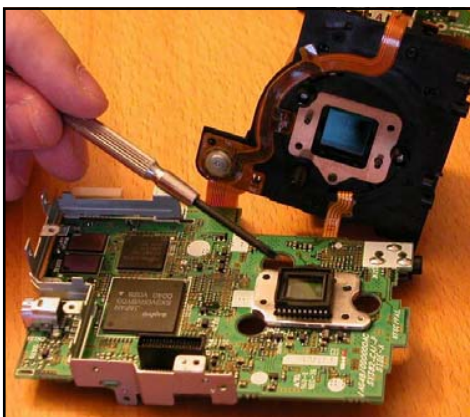
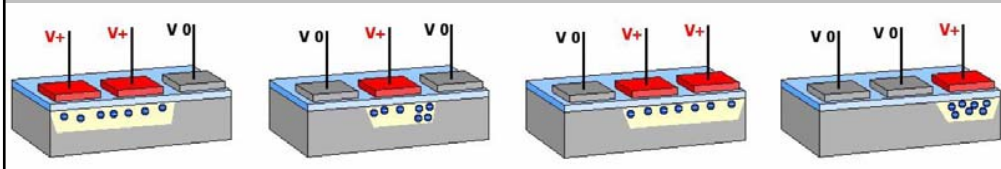
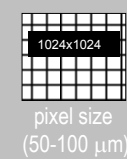
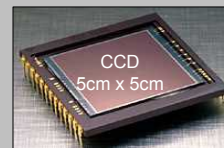
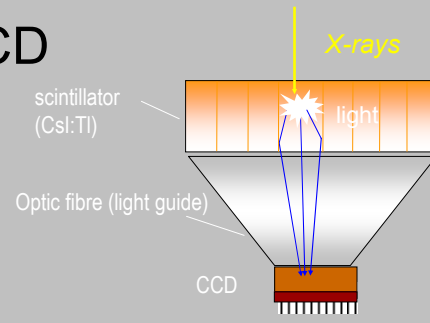

Each pixels in a Digital camera includes a photo sensor (photosite) which collects and stores photons, and a CCD which transfers the signal to a readout register. The relative quantity of photons in each photosite cavity are sorted into various intensity levels.

Micro-lens between photosites collects max number of photons

The final image is processed by special imager to finalise the resolution, contrast and colour.

## CCD basic principle

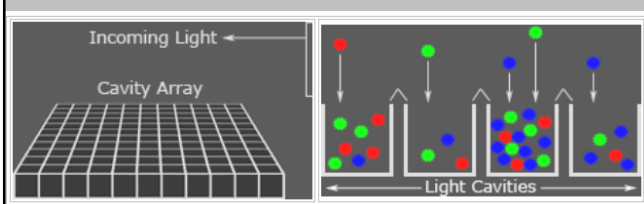

- The imaging chain includes:
- Photo optics (+colour filters)
  - Photo detectors (photosites)
  - Charge-coupled device
  - Readout register + Imager
  - Software (algorithm)

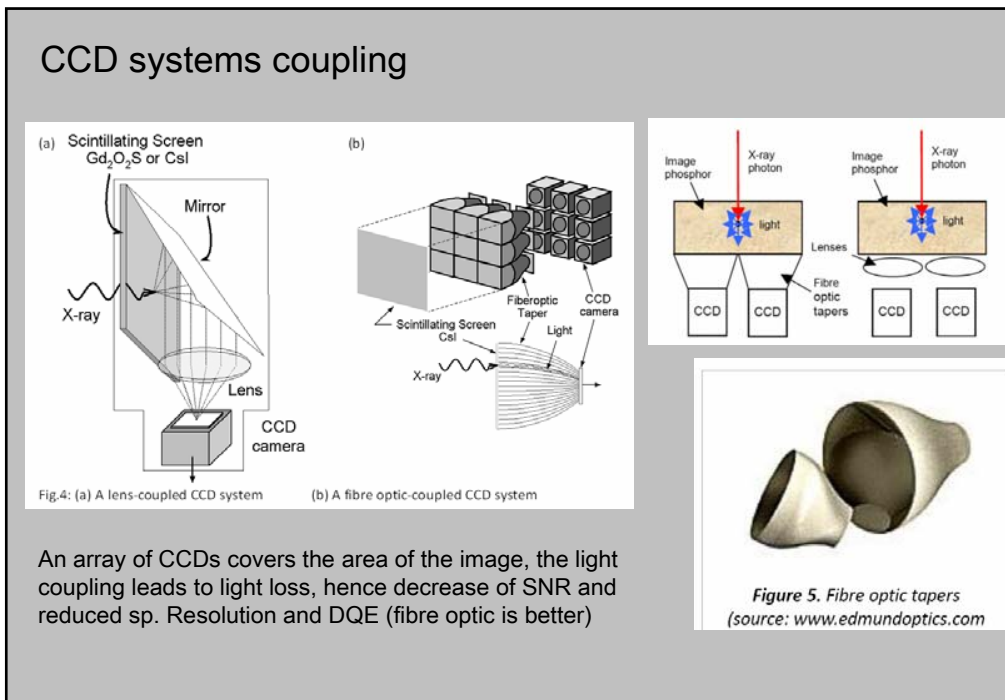
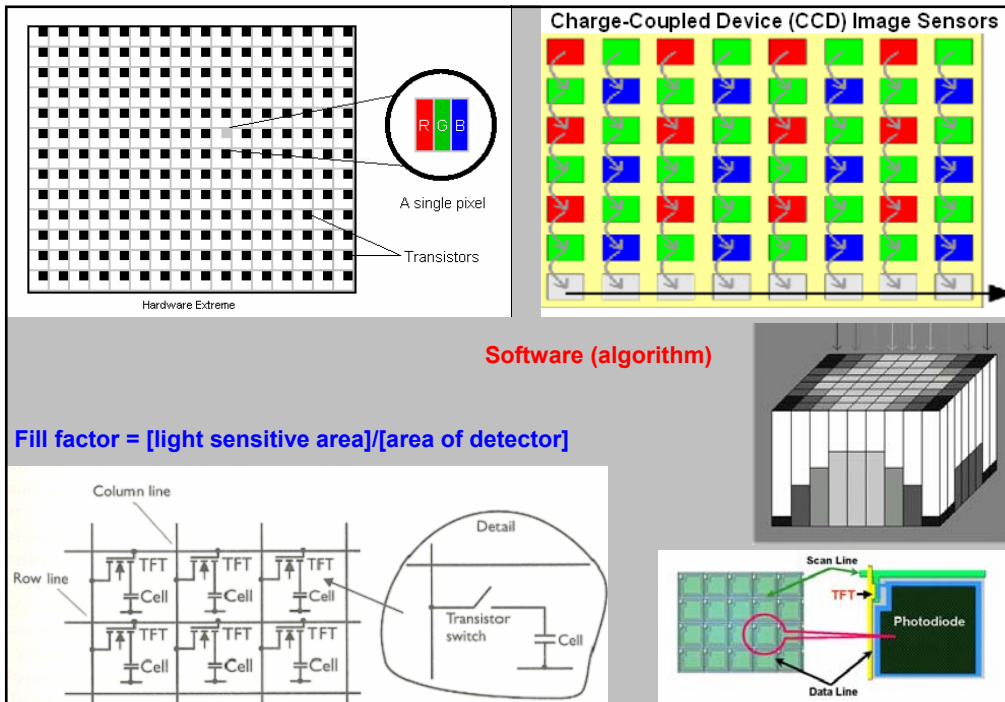

## Comparison of Digital Radiography systems

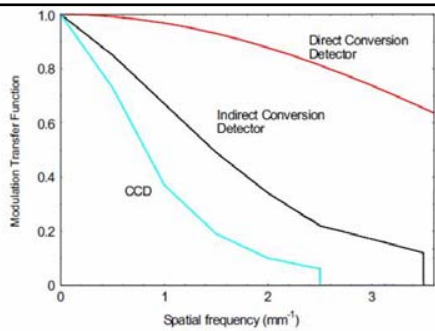

Best Sp. Resolution – a-Se

Best DQE / SNR - a-Si (higher DQE = better low contrast res.)

Best Cost - CR

CCD - ??

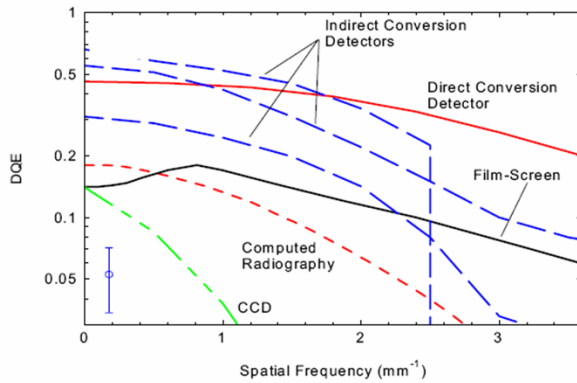

## Parameters of Digital Radiography systems (different types – real figures)

Table 1: Detectors characteristics. [19]

Detector name	aSe	aSi_1	aSi_2	CCD	CCD scan
Technology	a-Se/TFT array	a_Si:H photodiode/TFT array	a_Si:H photodiode/TFT array	CsI scintillator optically coupled to 4 CCDs	Slot scanning system with CsI directly coupled to CCD array
X-ray absorber	a-Se	CsI:Tl	CsI:Tl	CsI	CsI:Tl
Thickness of material (μm)	500	unknown	550	600	500
Image area (cm)	35.6×42.7	41×41	43×43	35×43	44×44
Pixel array	2560×3072	2022×2022	3001×3001	2048×2560	2720×2720
Pixel size (μm)	139	200	143	169	162

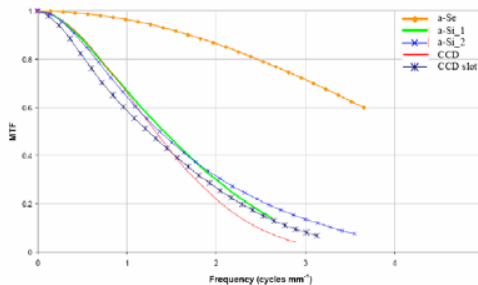
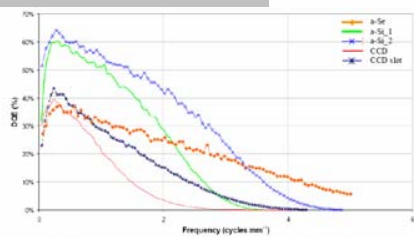

Average DQE of the various detectors acquired for x-ray settings of 70 keV and 4 μGy exposure.

The digital image of CR allows archiving and share of images through PACS.

The hard-copy image of all these devices is still made on film (exposed with Laser Imager).

As in many places the diagnosis is still made from film, the final image quality will still depend on the film and imager....

## High-Speed Processing

With the newly developed FFS System and 40-second rapid film processing, approximately 240 sheets of 14" x 17" (35 x 43 cm) film or 330 sheets of 10" x 14" (26 x 36 cm) film can be produced in one hour.

Printing various size film from multiple sources

CR images on 10" x 14" (26 x 36 cm) film and CT/MRI images on 14" x 17" (35 x 43 cm) films.

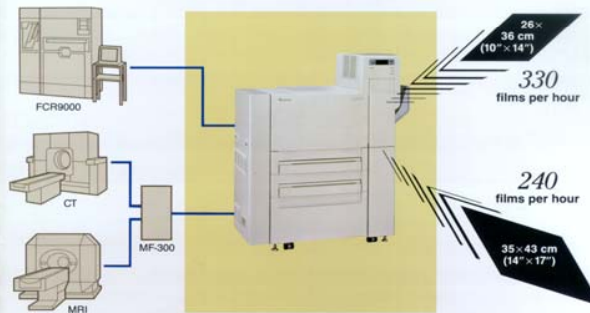

### Dry Laser Imager (Laser Camera)

Dry laser imager (78-micron laser spot spacing, 325-dpi resolution). Direct laser scanning over X-ray film. Laser is often infrared solid state laser of 820nm. In the image the Laser source intensity is constant and it is later modulated to create the necessary light intensities (grey levels).

Throughput of >100 films per hour. Image quality with selectable 50 or 100 micron pixel size, 12 bit gray-scale resolution, automatic density control and image interpolation technology. The imager can work with normal X-ray film and wet-type film processing. It allows PACS connection. The film for lasers is with cubic grains and not with tabular grains (as in screen-film)

Variations in image quality resulting from a not always optimal wet film development are frequent. A newly developed thermographic film developer for laser films without liquid powdered chemicals, is environmentally preferable and reducing operating costs.

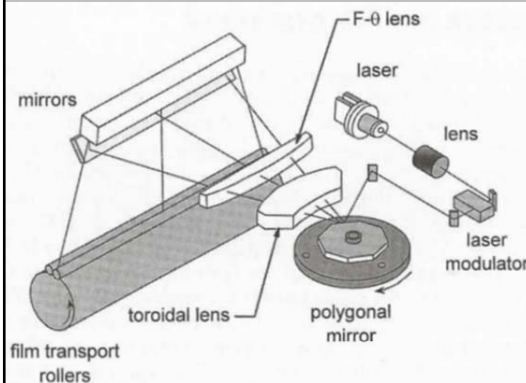

X-ray film with dry processing methods:

1. Adherographic – laser sensitive adhesive layer + imaging layer (carbon particles), both sandwiched between 2 polyester sheets. When the laser beam scans the dry-film it causes the adhesive layer to take carbon and stick it to the polyester sheet. As a result there are 2 sheets with positive and negative image. The first is coated and used as film, the other is disposed. The adhesion process is binary and the grey tone (nuance) is produced by dithering. Normally a cell of 16x16 pels makes a pixel with 256 grey levels. This requires very thin laser and small pels (5  $\mu\text{m}$ ) –  $16 \times 5 = 80 \mu\text{m}$  pixel = 6.25 lp/mm

2. Thermal - a combination of silver behenate and silver halide over polyester. The scanning laser beam triggers “thermal developing process” producing a “true” gray scale. However there is no fixer – i.e. the undeveloped silver halide crystals remain on the film, what makes it thermally unstable.

\* These imagers could have less grey levels as they are used with img. methods using “window”

SONY D71XR Laser Imager (Direct Thermal Printing)

Resolution: 300 dpi (with blue thermal film)

Gradation: 256 grey levels (memory: 16 MB)

Effective Print Pixels: 2743 x 2320 dots

Print Area: (232.2 x 196.4 mm); Interface: SCSI

Printing Time: Approx. 45 seconds

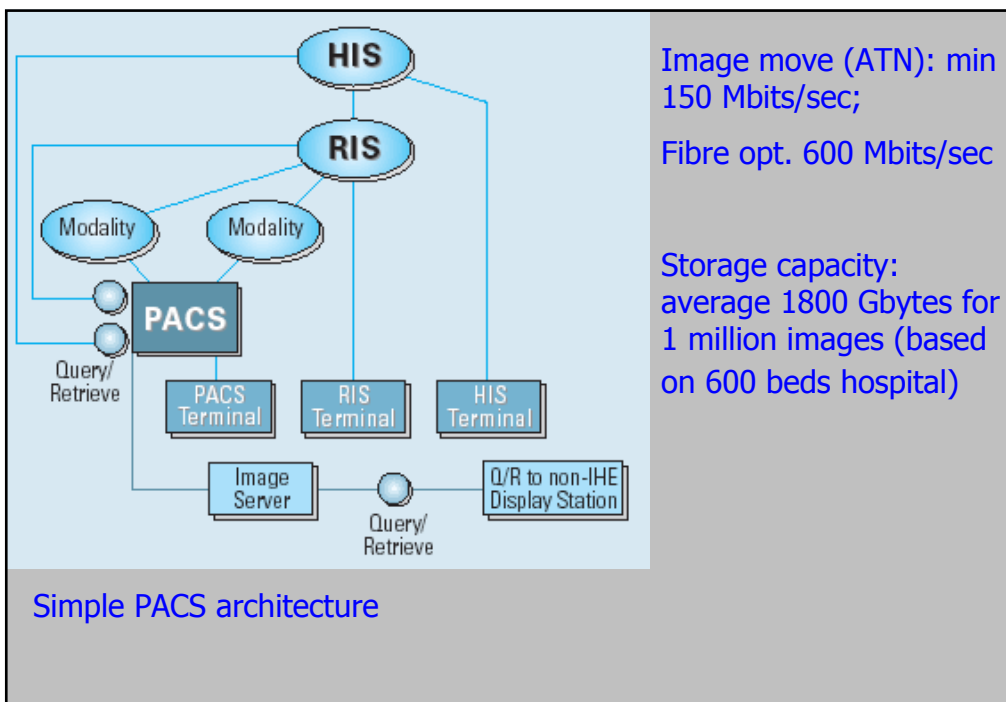

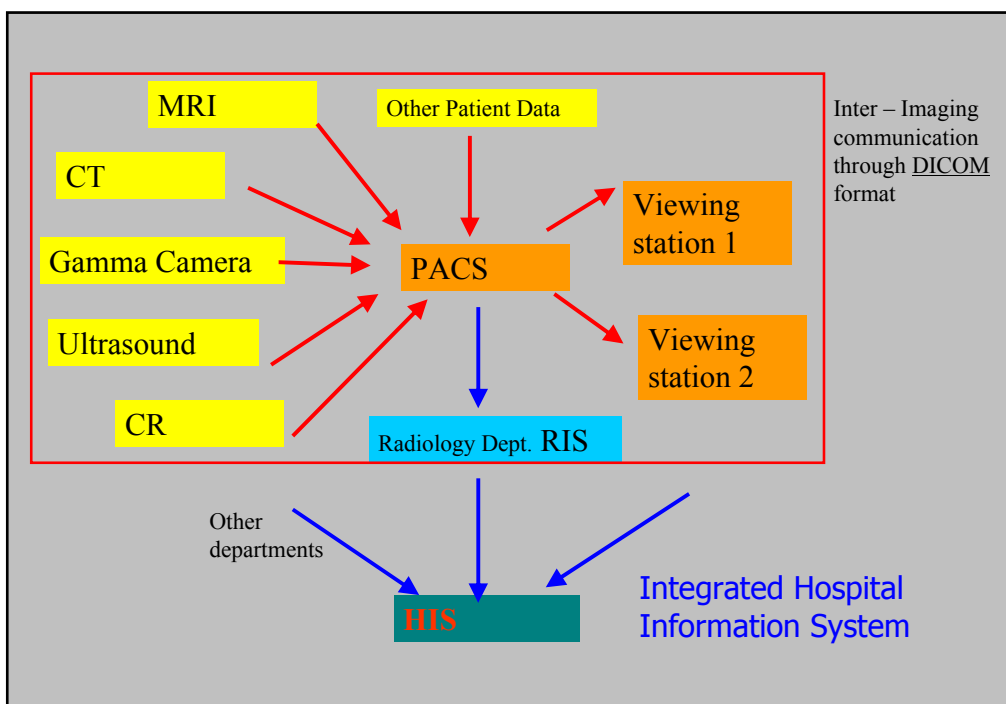
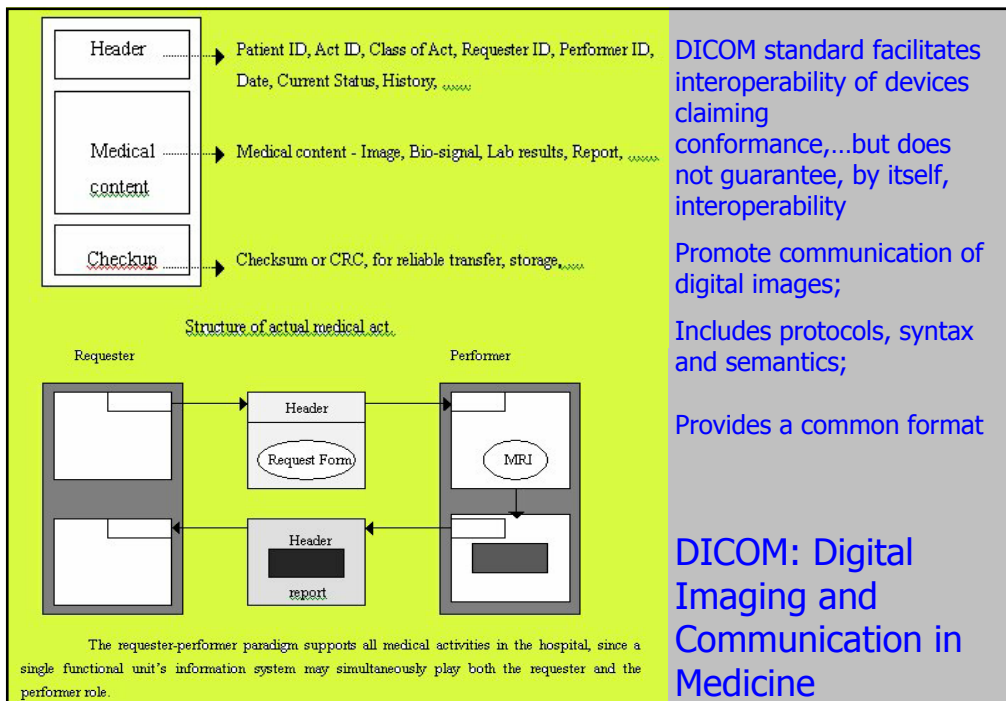



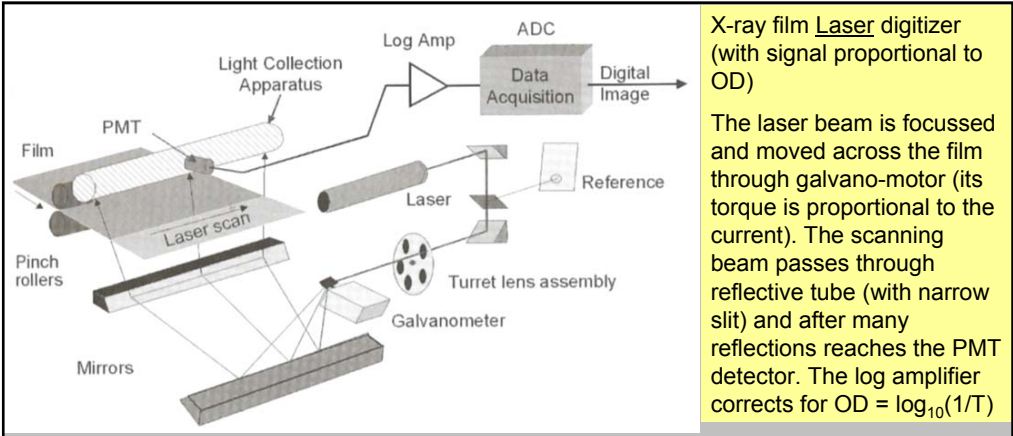

**Reminder for :** Light Transmittance (T) and Optical Density (OD)

$T = I/I_0$  [max T=1] ;  $OD = \log_{10}(1/T)$  [min OD = 0]

OD = 1 >>> T=0.1            medium grey

OD = 2 >>> T=0.01            dark

OD = 3 >>> T= 0.001            very dark [max.OD=4]

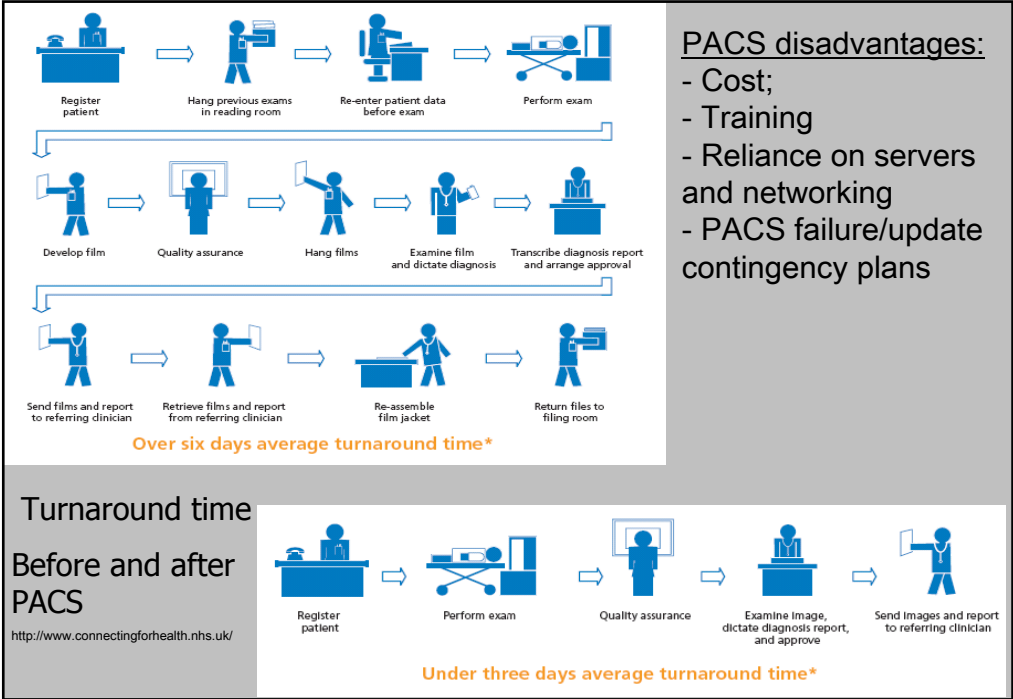

### Image quality and matrix size

Matrix size of 2048x2048 pixels can present resolution for field size 400x400 mm of the order of 0.2 mm pixel size ( $400/2048$ ) = 2.5 lp/mm. Smaller image field (200x200 mm), will have the same resolution (due to the geometry of the image).

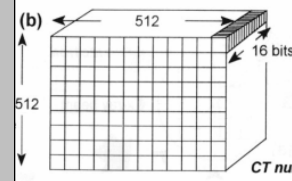

For scanners the final resolution will depend not only from the matrix size, but also from the density of projections. If a CT scanner has 512 mm scanning diameter and the matrix is 1024x1024 pixels, the pixel size will be 0.5 mm ( $512/1024$ ) = 1 lp/mm. If the scanner has collected sufficient number of projections, then part of this raw data can be used for subsequent reconstruction of another smaller image. For example if a ROI with diameter 128 mm is reconstructed, the pixel size of the final image will be 0.125 mm ( $128/1024$ ), what will present spatial resolution of 4 lp/mm.

Matrix depth (how many bits are included in one pixel) refers to the contrast resolution. Contemporary medical imaging matrices have 16 bits of depth, of which 12 bits are used for displaying the level of grey of the pixel, and the other 4 bits are used for supporting information (text or graphs). The 12 bits present  $2^{12} = 4096$  levels of grey (or colours), what is more than enough for the human visual system. 4096 levels of grey is also completely sufficient for various densitometric measurements

Finally a matrix size can be displayed 2048x2048x16 (4 mega pixel matrix), what will present approx. 67 Mega bits. Presented in Bytes (1 byte = 8 bits), the image file size will be 8 MB.

## Physical aspects of image quality and Practical examples

- **SNR - Signal-to-noise ratio.** The ratio of noise to picture signal information (ICRP 93 Glossary).
- In the context of the signal detection theory, the SNR is proportional to a ratio of the magnitude of the difference between the mean values of some quantity under two conditions that are to be distinguished, to a measure of the magnitude of statistical variation in that difference.

$$\text{SNR} = [\text{mean}(\text{background}) - \text{mean}(\text{ROI})] / \{1/2[\text{std}^2(\text{ROI}) + \text{std}^2(\text{background})]\}^{1/2}$$

ROI = Region of interest

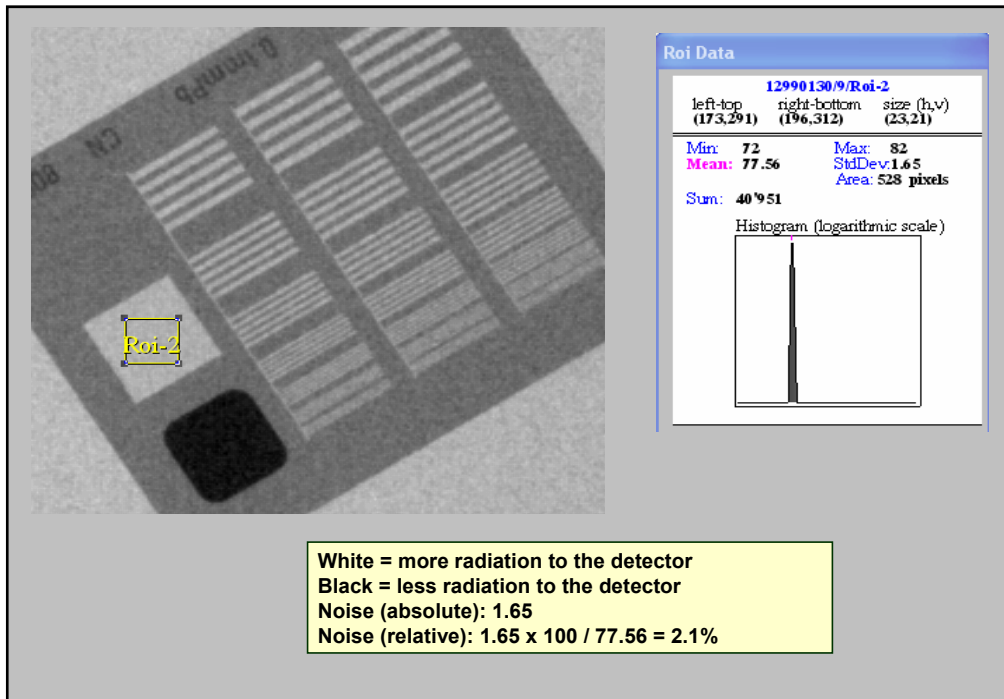

## Correlation of image parameters with dose

- The noise typically decreases when radiation dose increases.
- SNR is proportional to the square root of the average number of x-ray quanta and typically improves when increasing dose.
- Contrast improves for low kVp X ray beams (low energy photons).

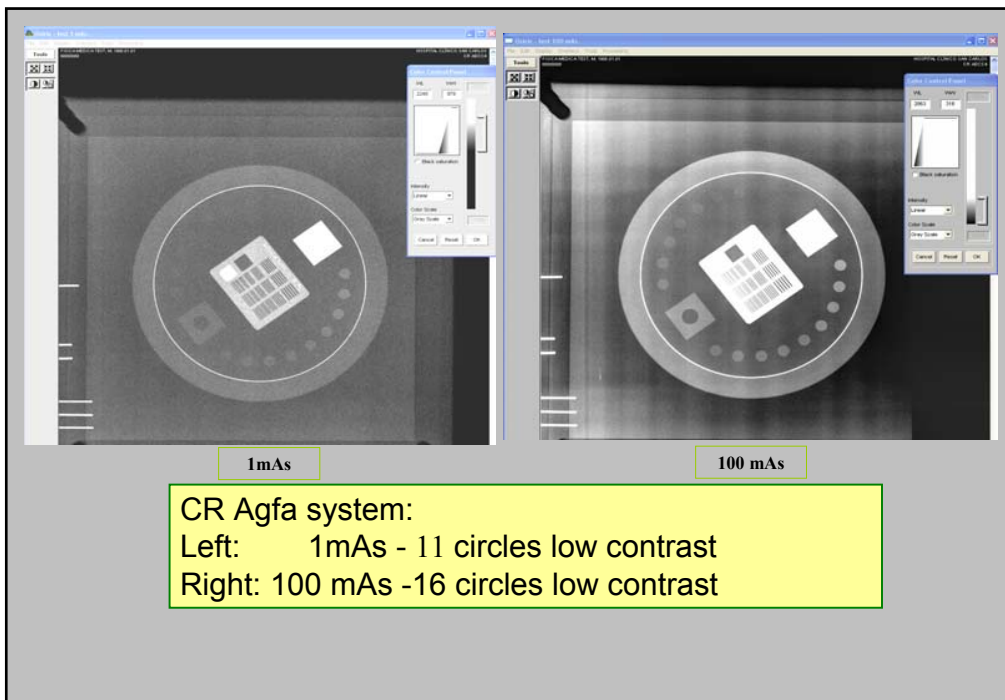
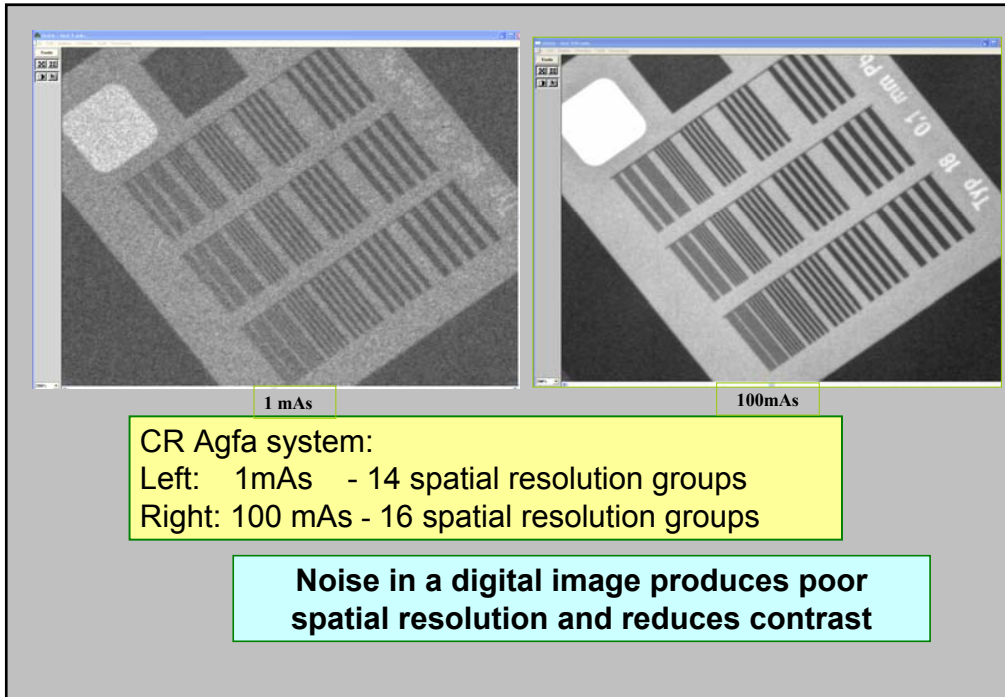



Example of clinical images obtained with two different levels of dose and noise

Relative dose level (Agfa system)  
1.15 (image too noisy)

Relative dose level (Agfa system) 1.87  
(image with enough quality) (with approx.  
5 times more dose at the entrance)

## Effect of the post-processing

- The standard post-processing parameters offered in some CR workstations includes the noise reduction and the edge enhancement.
- Some examples are shown for the Agfa post-processing called “MUSICA” (Multi Scale Image Contrast Enhancement). This is the basic principle of MUSICA:
  - contrast enhancement irrespective of feature size.
  - difference with respect to spatial frequency band filtering.

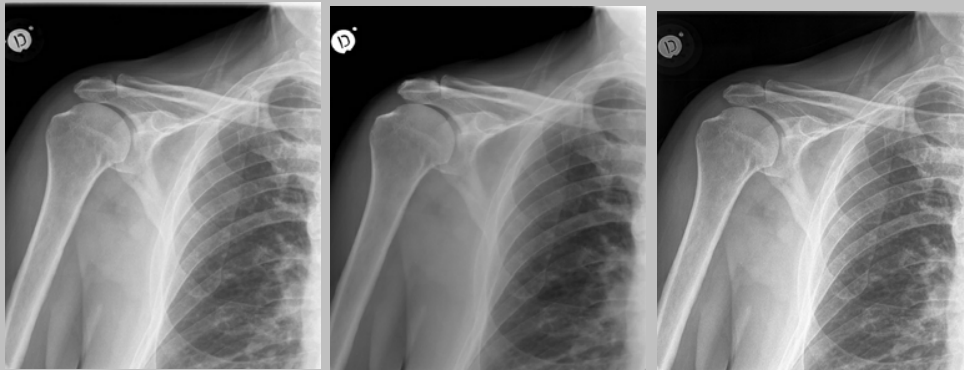

Standard image

Noise reduction

Edge enhancement

Examples of different post-processing using Agfa CR software (MUSICA)



Same image, two different postprocessings?

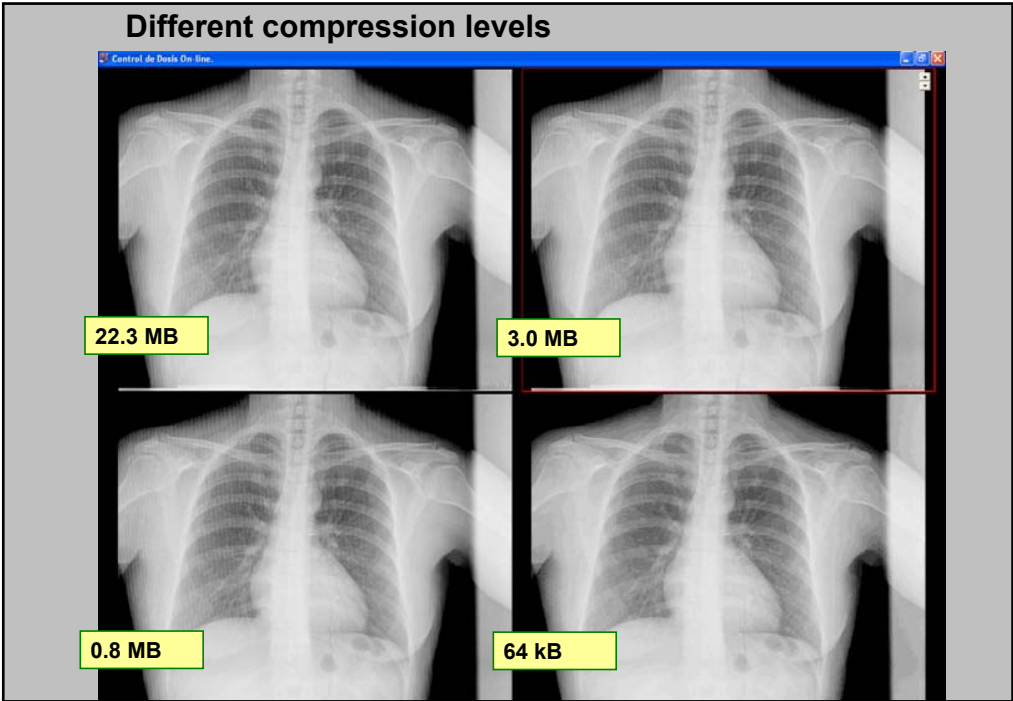
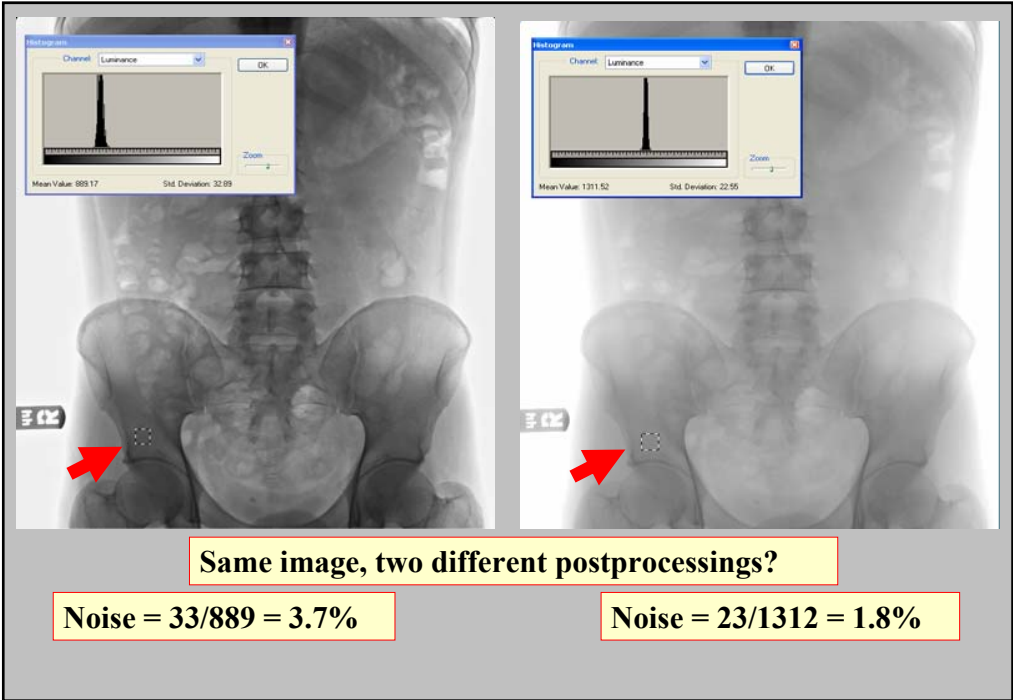

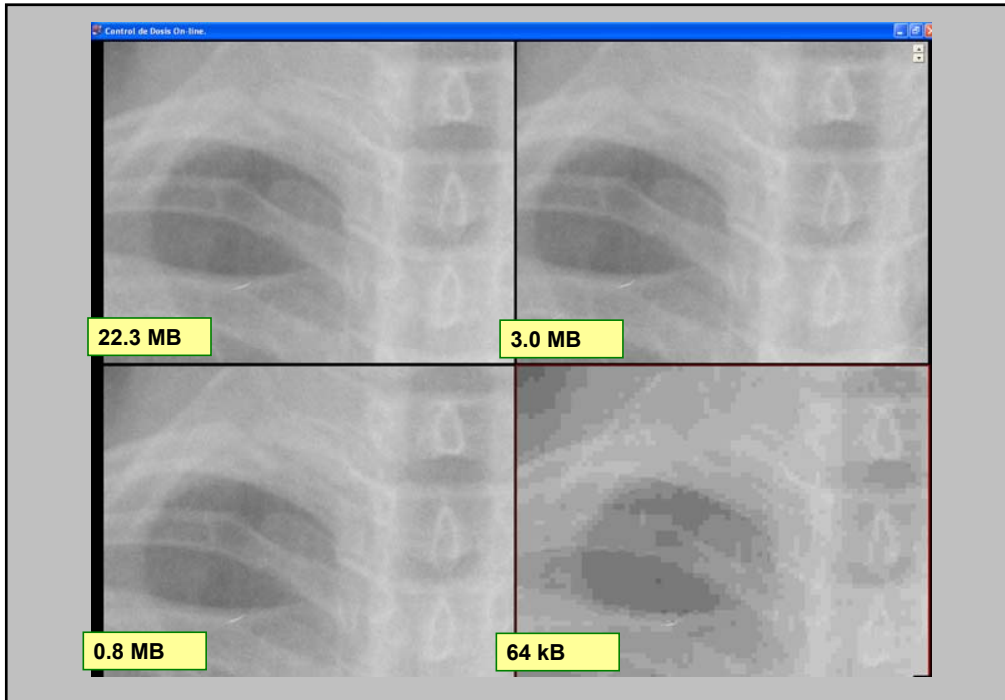

Patient Dose  
More dose better image quality

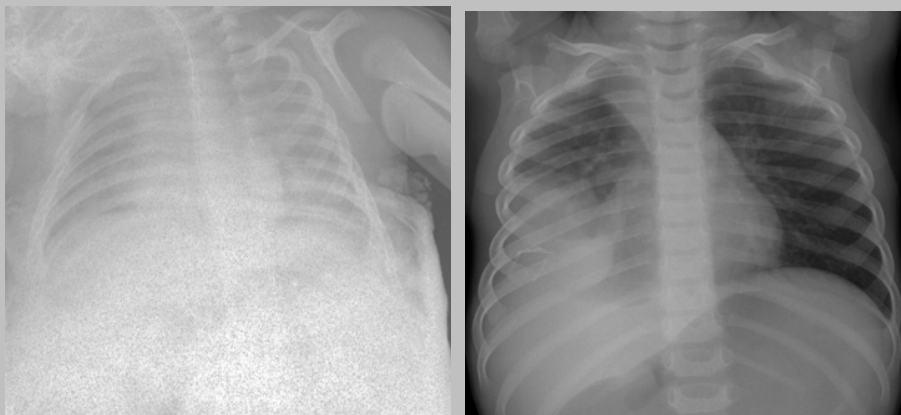



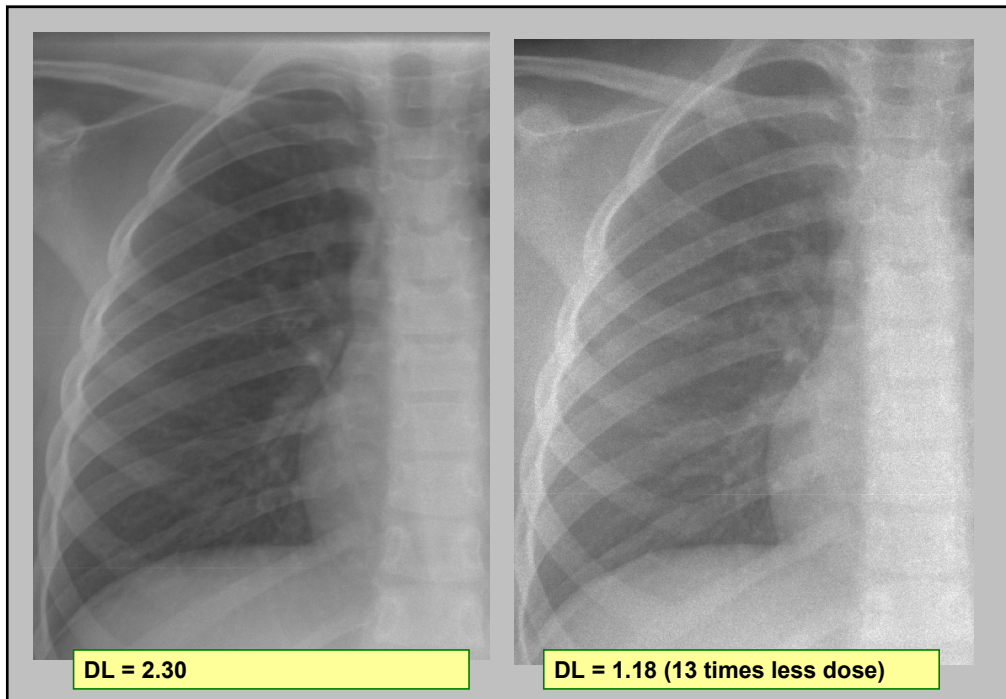

## Digital radiography and digital fluoroscopy. Differences with conventional

### → Advantages

- More information can be obtained from the image (change of window and level, magnification, etc).
- Wide dynamic range (more tolerance to different dose values).
- Easy archive and transmission by networks.

### → Disadvantages

- Over exposures could not be noticed.
- Very easy to delete the files of the bad quality images.
- A tendency to obtain more images than necessary could occur.
- Audit of relevant radiation protection parameters can sometimes be difficult.

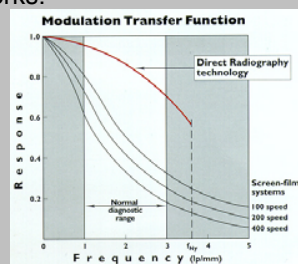

## Monitors: photometer measurement

Poor conditions of the visualization monitor (e.g. lack of enough brightness or contrast, poor spatial resolution, etc) can require repetitions of exposures.

Such a visualization monitor produces sub-standard image quality.

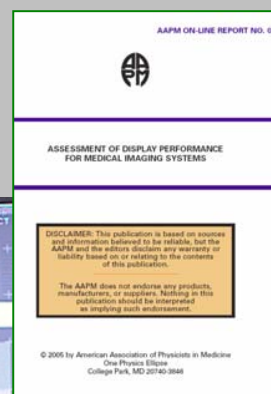
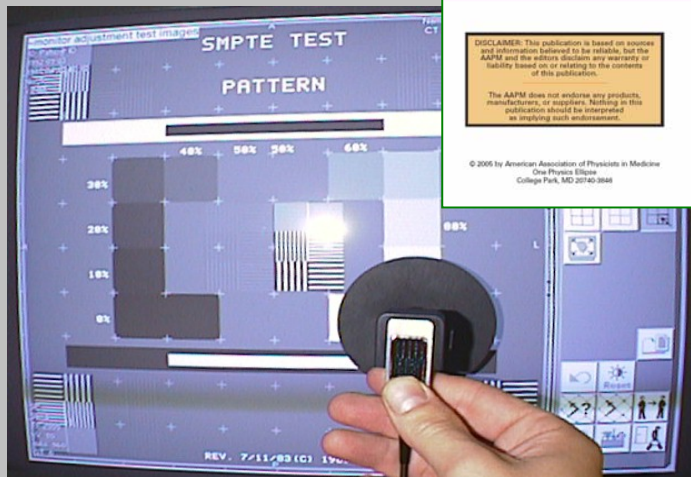

## CDRAD phantom

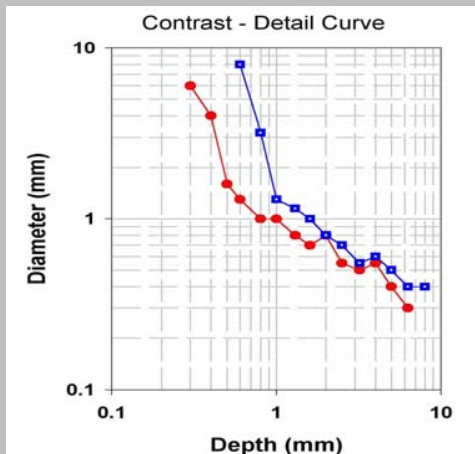
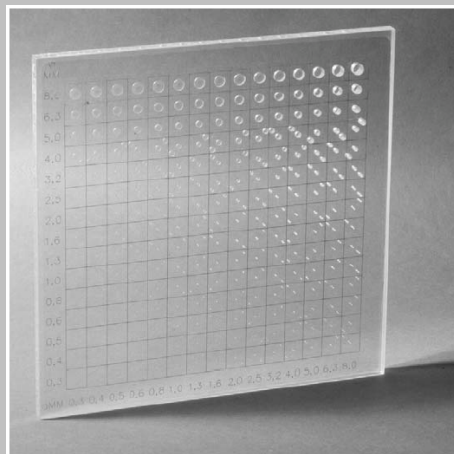

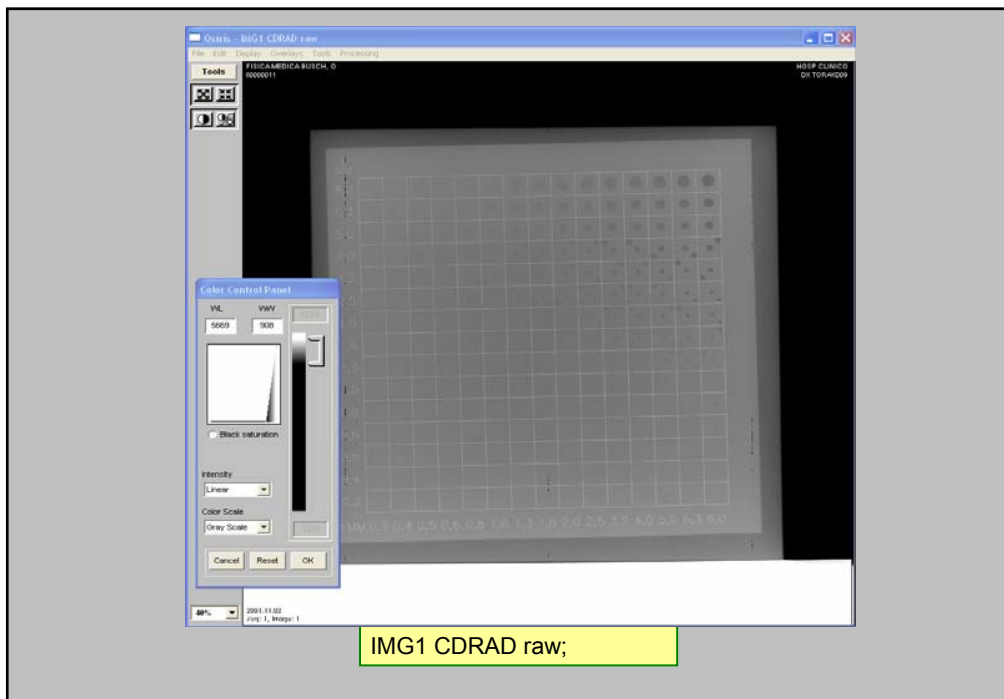

## CDRAD phantom

- The image shows 225 squares, 15 rows and 15 columns. In each square either one or two spots are present, being the images of the holes.
- The first three rows show only one spot, while the other rows have two identical spots, one in the middle and one in a randomly chosen corner.

## CDMAM phantom

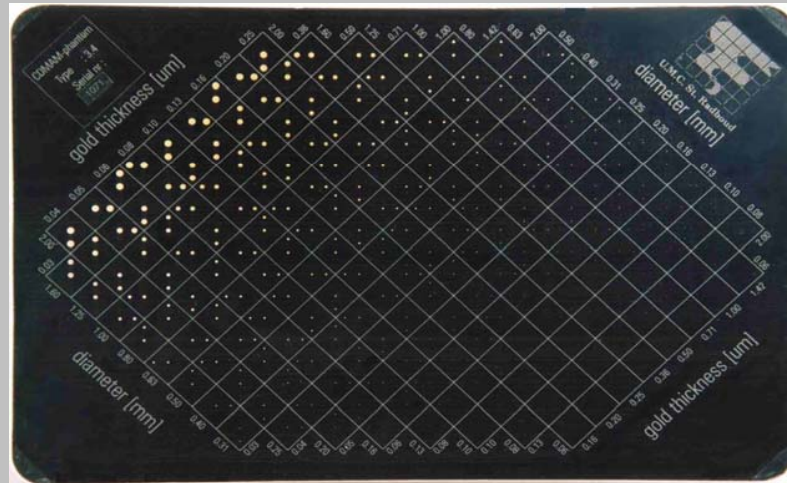

## AutoQC: resolution, uniformity, linearity

→ Automatic evaluation made by the software

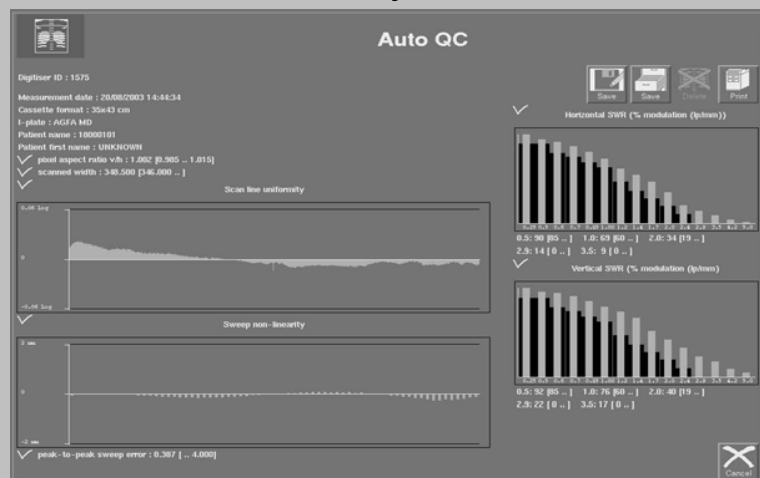

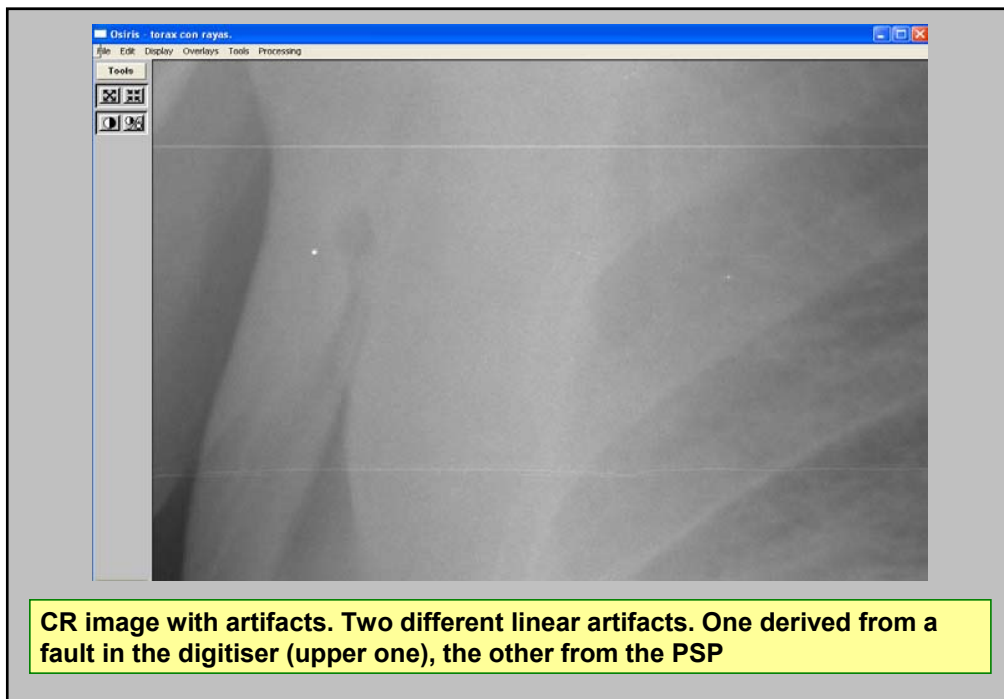

## Acknowledgments

- Figures from Agfa, Siemens, Philips, GE, Fuji and Toshiba systems have been used.
- Materials from IAEA Training Material on Radiation Protection in Digital Radiology have been used
- Images from Prof. Perry Sprawls, Dr. Ramon Sanchez-Jacob, Dr. Eliseo Vano-Galvan, Dr Anchali Krisanachinda, Petcharleeya Suwanpradit, and Ana Pascoal have been used
- Images from EMERALD materials and Dr S Tabakov have been used