

*SUMMER SCHOOL ON PARTICLE PHYSICS*

16 June - 4 July 2003

PHYSICS OF FUTURE ACCELERATOR EXPERIMENTS

**A. BLONDEL**  
University of Geneva  
Geneva  
SWITZERLAND



## Physics at future accelerator experiments

1. The questions that we ask and the energy scales at which we think they happen
2. Physics of the known fermions: Neutrino physics  
the issues in neutrino experiments neutrino factories
- 2.' physics involving the GUT scale:proton decay
3. physics of the electroweak and nearby energy scale  
LHC  
the future lepton colliders

Alain Blondel 

### Fundamental questions in elementary particle physics

- ⌘ What are the elementary constituents of matter?
- ⌘ What are forces acting between them?
- ⌘ How did the Universe begin and evolve?

$$d = 10^{-16} \text{ cm} \leftrightarrow E = 10^3 \text{ GeV} = 1 \text{ TeV}$$

$$\leftrightarrow T = 10^{16} \text{ K} \leftrightarrow t = 10^{-12} \text{ sec}$$

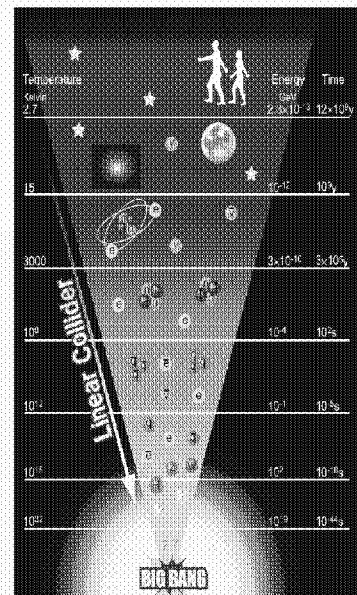

Alain Blondel 

Our current understanding =  
The Standard Model of  
elementary particle physics

Matter  
:

quark		lepton	
u	d	e	$\nu_e$
c	s	$\mu$	$\nu_\mu$
t	b	$\tau$	$\nu_\tau$

Forces:

	Strong force	Electro-weak force		Gravity
Force		Electro-magnetic force	Weak force	
Exchanged particles	Gluon	Photon	W, Z bosons	Graviton
Magnitude	1	0.01	$10^{-5}$	$10^{-40}$
Scale	Nuclei	Molecules, Atom	Neutron decay	Gravitation
Examples	Hadron	Electronics	Nuclei decay	Galaxy
Other	Nuclear fusion	Synchrotron rad.	Radioactive	Black Hole
	Solar energy	Fusion	Geothermal	Super-Fractal

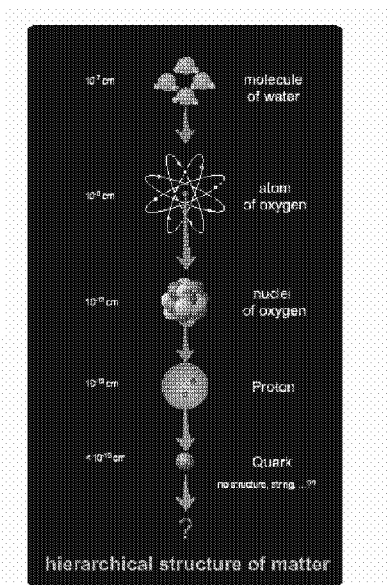

Alain Blondel

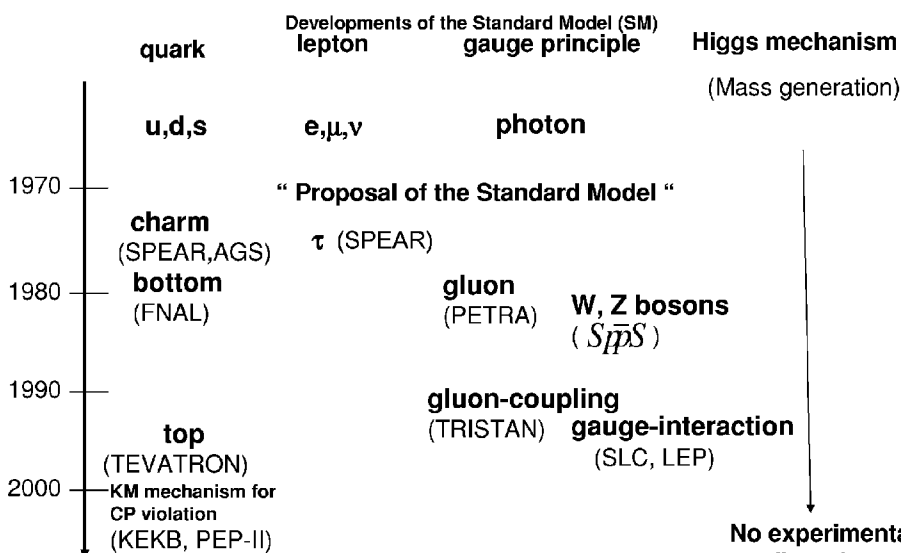

No experimental  
confirmation

Alain Blondel



•Unification

Supersymmetric grand unified theory, Superstring.

•Neutrino mass

SuperKamokande, Cl,Ga, exp., K2K, SNO, KamLAND, ...

•Cosmology

Dark matter, Baryogenesis, Inflation,...



Need a higher energy than 100 GeV.

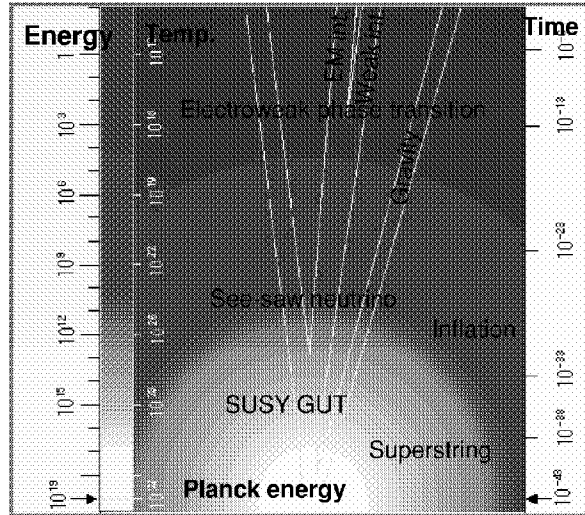

Alain Blondel

The Energy quest: pp or pp colliders

accelerator	date	$E_{cm}$	$E_{cm}$ effective
ISR	1971	62 GeV	~8 GeV
spps	1982	540 GeV	~90 GeV
TeVatron	1987	2 TeV	~350 GeV
LHC	2007	14 TeV	~2 TeV

factor 225 in 36 years

factor 2 in every 4.3 years (almost the same, a little faster)

discoveries: large Pt, W and Z boson, top quark

Alain Blondel

### The Energy quest: high intensity fixed target proton acc

accelerator	date	$E_{cm}$	$E_{cm}$ effective
Bevatron	1955	4	~2 GeV
PS (BNL, CERN, etc..)	1959	7.5	~4 GeV
SPS	1976	28 GeV	~10 GeV
TeVatron	1972-1990	63 GeV	~15 GeV

factor 15 in 35 years: not the way to high energy!  
 discoveries: antiproton, many resonances,  $K^0$  oscillations, CP violation,  
 all three neutrinos, Neutral Currents,  $J/\psi$ , Y, quark model, etc.. etc...

Alain Blondel 

### The Energy quest: $e^+e^-$ colliders

accelerator	date	$E_{cm}$	$E_{cm}$ effective
$e^+e^-$ ring SPEAR	1974	8 GeV	8 GeV
$e^+e^-$ ring PETRA	1979	40 GeV	40 GeV
$e^+e^-$ lin. SLC	1987	90 GeV	90 GeV
$e^+e^-$ ring LEP I	1989	100 GeV	100 GeV
$e^+e^-$ ring LEP II	1996	200 GeV	200 GeV
$e^+e^-$ lin. WorldLC	201X	800 GeV	800 GeV

22 years for a factor 25 ... when will we reach  $10^{15}$  GeV?  
 A. 220 years or so, if it is a factor 2 every so many(5) years.  
 B. And this involve a lot of R&D on accelerators.

discoveries:  $J/\psi$  & charmonia, gluon, tau lepton  
 precise measurements of b-system (still at it with b factories)  
 and of the Z and W boson! Best limit on the Higgs so far.

Alain Blondel 

**Physics with accelerators can be broadly divided in two classes**

**1. physics at the present energy frontier**

presently: the Electroweak scale and the Higgs boson (generation of W and Z masses)

**2. precise measurements of properties of already known particles/interactions**

(K, B, muon, neutrinos, tests of QED, SM, QCD)

Neutrinos are, today, the most interesting because their mass

(and mixing process) seem to originate in very high energies (see-saw mechanism)

These lectures will begin with a novel type of accelerator that is being developed conceptually now: neutrino sources with storage rings

→ neutrino factory and beta beams

Alain Blondel 

### **neutrino definitions**

**the electron neutrino is present in association with an electron (e.g. beta decay)**

**the muon neutrino is present in association with a muon (pion decay)**

**the tau neutrino is present in association with a tau ( $W \rightarrow \tau \nu$  decay)**

**these flavor-neutrinos are not (as we know now) quantum states of well defined MASS (neutrino mixing)**

**the mass-neutrino with the highest electron neutrino content is called  $\nu_1$**

**the mass-neutrino with the next-to-highest electron neutrino content is  $\nu_2$**

**the mass-neutrino with the smallest electron neutrino content is called  $\nu_3$**

Alain Blondel 

## Lepton Sector Mixing

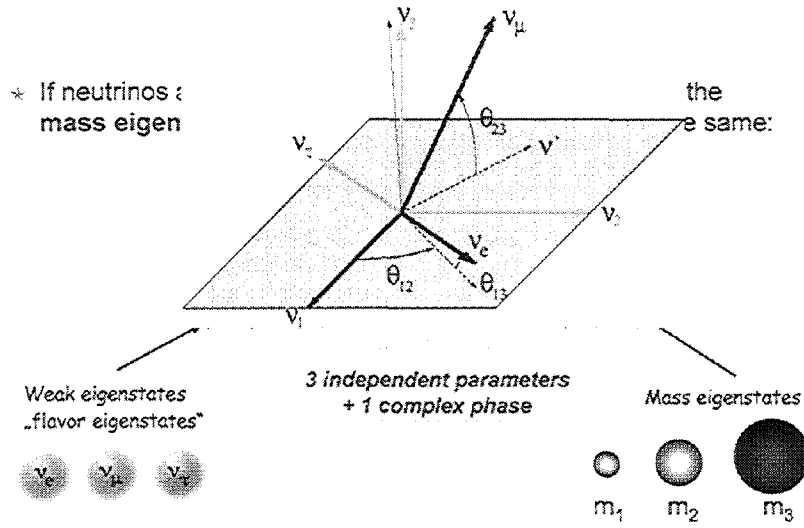

Pontecorvo 1957

Alain Blondel



## Neutrino Oscillations (Quantum Mechanics lesson 5)

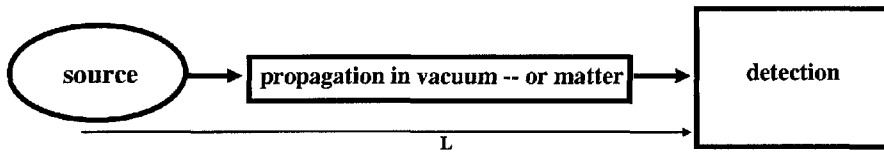

weak interaction produces 'flavour' neutrinos

e.g. pion decay  $\pi \rightarrow \mu\nu$   
 $|\nu_\mu\rangle = \alpha |\nu_1\rangle + \beta |\nu_2\rangle + \gamma |\nu_3\rangle$

Energy (i.e. mass) eigenstates propagate

$$|\nu(t)\rangle = \alpha |\nu_1\rangle \exp(i E_1 t) + \beta |\nu_2\rangle \exp(i E_2 t) + \gamma |\nu_3\rangle \exp(i E_3 t)$$

$t = \text{proper time} \propto L/E$

weak interaction: (CC)

$$\nu_\mu N \rightarrow \mu^- X$$

or  $\nu_e N \rightarrow e^- X$

or  $\nu_\tau N \rightarrow \tau^- X$

$$P(\mu \rightarrow e) = |\langle \nu_e | \nu(t) \rangle|^2$$

Alain Blondel





## Oscillation Probability

★ The case with two neutrinos:

→ A mixing angle:  $\theta$

→ A mass difference:

$$\Delta m^2 = m_2^2 - m_1^2$$

$$\begin{pmatrix} \nu_\alpha \\ \nu_\beta \end{pmatrix} = \begin{pmatrix} \cos\theta & \sin\theta \\ -\sin\theta & \cos\theta \end{pmatrix} \begin{pmatrix} \nu_1 \\ \nu_2 \end{pmatrix}$$

★ The oscillation probability is:

$$P(\nu_\alpha \rightarrow \nu_\beta) = \sin^2 2\theta \sin^2 \left( 1.27 \Delta m^2 \frac{L}{E} \right)$$

where  $L$  = distance between source and detector  
 $E$  = neutrino energy

*Hamiltonian* =  $E = \text{sqrt}(p^2 + m^2) = p + m^2 / 2p$

for a given momentum, eigenstate of propagation in free space are the mass eigenstates!

Alain Blondel



### To complicate things further: matter effects elastic scattering of (anti) neutrinos on electrons

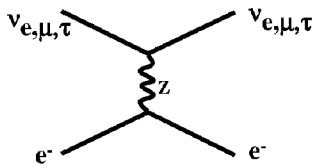

all neutrinos and anti neutrinos do this equally

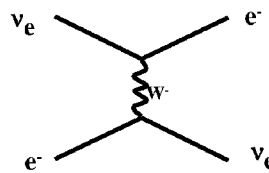

only electron neutrinos

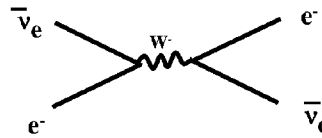

only electron anti-neutrinos

These processes add a forward amplitude to the Hamiltonian, which is proportional to the number of electrons encountered to the Fermi constant and to the neutrino energy.

The Z exchange is diagonal in the 3-neutrino space  
 this does not change the eigenstates

The W exchange is only there for electron neutrinos

It has opposite sign for neutrinos and anti-neutrinos (s vs t-channel exchange)

$$D = \pm 2\sqrt{2} G_F n_e E_\nu$$

**THIS GENERATES A FALSE CP VIOLATION**

Alain Blondel



$$H_{\text{flavour base}} = U \begin{pmatrix} m_1^2 & 0 & 0 \\ 0 & m_2^2 & 0 \\ 0 & 0 & m_3^2 \end{pmatrix} U^\dagger + \begin{pmatrix} D & 0 & 0 \\ 0 & 0 & 0 \\ 0 & 0 & 0 \end{pmatrix}$$

$D = \pm 2\sqrt{2} G_F n_e E_\nu$

This is how YOU can solve this problem: write the matrix, diagonalize, and evolve using,

$$i \frac{\partial \psi}{\partial t} = H \psi$$

This has the effect of modifying the eigenstates of propagation!  
 Mixing angle and energy levels are modified, this can even lead to level-crossing. *MSW effect*

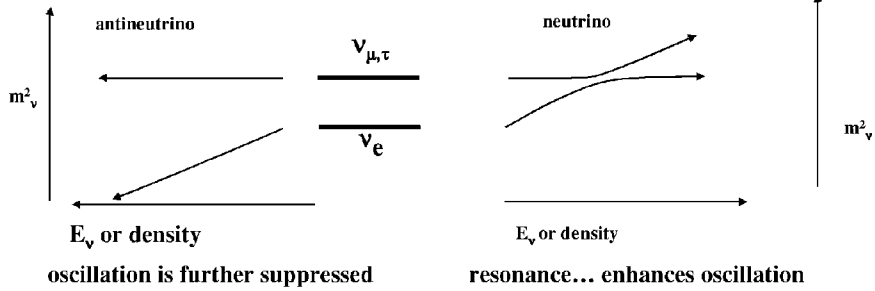

oscillation is **enhanced** for neutrinos if  $\Delta m^2_{1x} > 0$ , and suppressed for antineutrinos  
 oscillation is **enhanced** for antineutrinos if  $\Delta m^2_{1x} < 0$ , and suppressed for neutrinos  
 since **T asymmetry** uses neutrinos it is **not affected**

Alain Blondel

## Oscillation Phenomena

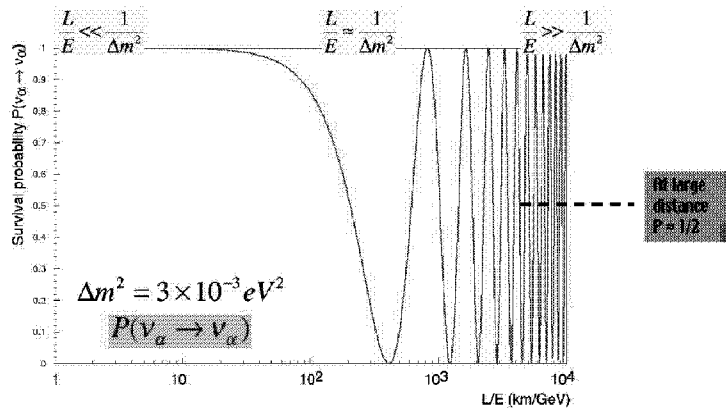

Alain Blondel

**General framework:**

1. We know that there are three families of active, light neutrinos (*LEP*)
2. Solar neutrino oscillations are established (*Homestake+Gallium+Kam+SK+SNO+KamLAND*)
3. Atmospheric neutrino ( $\nu_\mu \rightarrow \nu_e$ ) oscillations are established (*IMB+Kam+SK+Macro+Sudan*)
4. At that frequency, electron neutrino oscillations are small (*CHOOZ*)

This allows a consistent picture with 3-family oscillations preferred:

LMA:  $\theta_{12} \sim 30^\circ$ ,  $\Delta m_{12}^2 \sim 7 \cdot 10^{-5} \text{eV}^2$ ,  $\theta_{23} \sim 45^\circ$ ,  $\Delta m_{23}^2 \sim \pm 2.5 \cdot 10^{-3} \text{eV}^2$ ,  $\theta_{13} < \sim 10^\circ$   
with several unknown parameters

=> an exciting experimental program for at least 25 years \*)  
including leptonic CP & T violations

5. There is indication of possible higher frequency oscillation (LSND) to be confirmed (*miniBooNe*)  
This is not consistent with three families of neutrinos oscillating, and is not supported (nor is it completely contradicted) by other experiments.  
(Case of an unlikely scenario which hangs on only one not-so-convincing experimental result)  
If confirmed, this would be even more exciting

(I will not explore this here, but this has been done. See *Barger et al PRD 63 033002*)

\*)to set the scale: CP violation in quarks was discovered in 1964  
and there is still an important program (K0pi0,B-factories, Neutron EDM, BTeV, LHCb..) to go on for 10 years...i.e. a total of ~50 yrs.

and we have not discovered leptonic CP yet!

Alain Blondel



**The neutrino mixing matrix:  
3 angles and a phase  $\delta$**

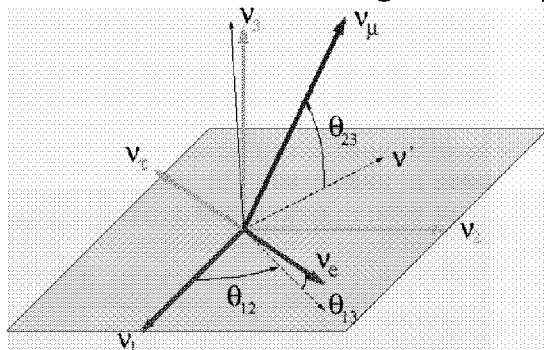

$\theta_{23}$  (atmospheric) =  $45^\circ$ ,  $\theta_{12}$  (solar) =  $30^\circ$ ,  $\theta_{13}$  (Chooz) <  $13^\circ$

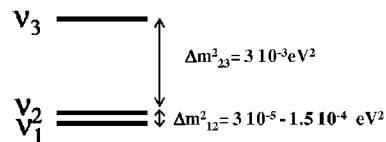

OR?

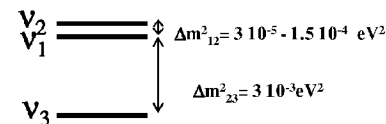

$$U_{MNS} = \begin{pmatrix} \sim \frac{\sqrt{2}}{2} & \sim -\frac{\sqrt{2}}{2} & \sin \theta_{13} e^{i\delta} \\ \sim \frac{1}{2} & \sim \frac{1}{2} & \sim -\frac{\sqrt{2}}{2} \\ \sim \frac{1}{2} & \sim \frac{1}{2} & \sim \frac{\sqrt{2}}{2} \end{pmatrix}$$

Unknown or poorly known  
even after approved program:  
 $\theta_{13}$ , phase  $\delta$ , sign of  $\Delta m_{13}^2$

Alain Blondel



### neutrino mixing (LMA, natural hierarchy)

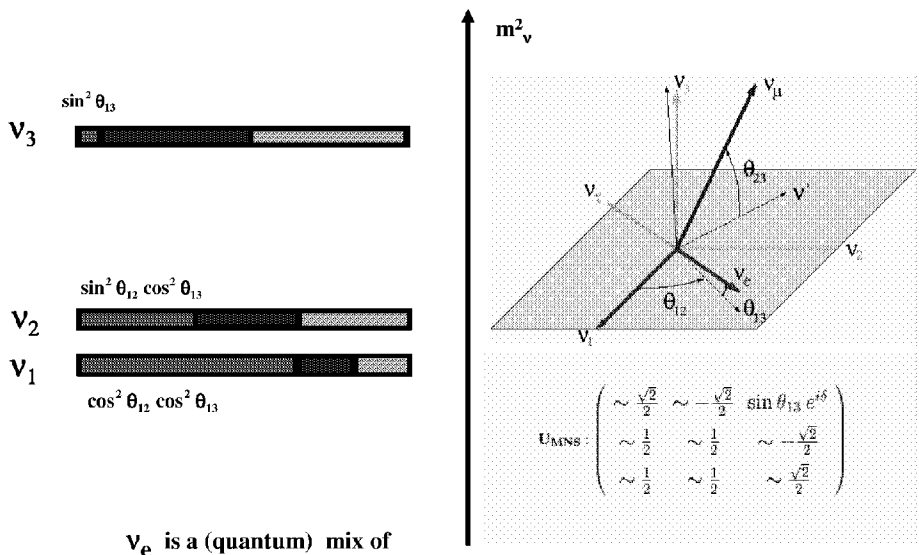

$\nu_e$  is a (quantum) mix of  $\nu_1$  (majority, 65%) and  $\nu_2$  (minority 30%) with a small admixture of  $\nu_3$  (< 13%) (CHOOZ)

Alain Blondel

$$P(\nu_e \rightarrow \nu_\mu) = |A|^2 + |S|^2 + 2 A S \sin \delta$$

$$P(\bar{\nu}_e \rightarrow \bar{\nu}_\mu) = |A|^2 + |S|^2 - 2 A S \sin \delta$$

$$\frac{P(\nu_e \rightarrow \nu_\mu) - P(\bar{\nu}_e \rightarrow \bar{\nu}_\mu)}{P(\nu_e \rightarrow \nu_\mu) + P(\bar{\nu}_e \rightarrow \bar{\nu}_\mu)} = A_{CP} \propto \frac{\sin \delta \sin(\Delta m^2_{12} L/4E) \sin \theta_{12}}{\sin \theta_{13} + \text{solar term...}}$$

- ... need large values of  $\sin \theta_{12}$ ,  $\Delta m^2_{12}$  (LMA) but \*not\* large  $\sin^2 \theta_{13}$
- ... need APPEARANCE ...  $P(\nu_e \rightarrow \nu_e)$  is time reversal symmetric (reactors or sun are out)
- ... can be large (30%) for suppressed channel (one small angle vs two large)
  - at wavelength at which 'solar' = 'atmospheric' and for  $\nu_e \rightarrow \nu_\mu, \nu_\tau$
- ... asymmetry is opposite for  $\nu_e \rightarrow \nu_\mu$  and  $\nu_e \rightarrow \nu_\tau$

Alain Blondel

### Regarding the parameters' choice.

- Amplitude is driven by  $\sin^2(2\theta_{12})$
- Wavelength is driven by  $\delta m_{23}^2$
- But also  $\delta m_{12}^2$ , its sign,  $\delta$ ,  $\sin^2 2\theta_{23}$ ,  $\sin^2 2\theta_{13}$  have sizable effects

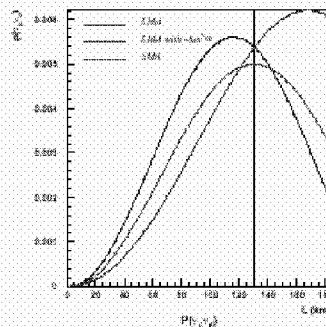
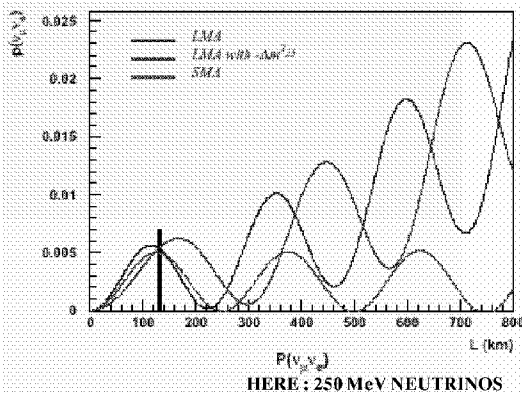

Alain Blondel



### Asymmetry for $\sin \delta = 1$

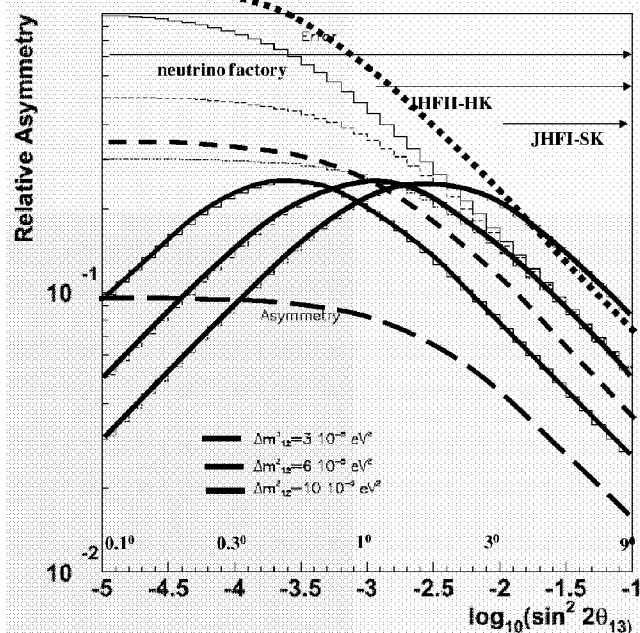

! asymmetry is a few % and requires excellent flux normalization (neutrino fact. or off axis beam with not-too-near near detector)

Alain Blondel



## Road Map

Experiments to find  $\theta_{13}$  :

1. search for  $\nu_\mu \rightarrow \nu_e$  in conventional  $\nu_\mu$  beam (ICARUS, MINOS)  
 limitations: NC  $\pi^0$  background, intrinsic  $\nu_e$  component in beam
2. Off-axis beam (JHF-SK, off axis NUMI, off axis CNGS) or
3. Low Energy Superbeam

Experiments to find CP violation or to search further if  $\theta_{13}$  is too small

1. Neutrino factory with muon storage ring

$$\mu^+ \rightarrow e^+ \nu_e \bar{\nu}_\mu \text{ and } \mu^- \rightarrow e^- \bar{\nu}_e \nu_\mu$$

2. beta-beam  ${}^6\text{He}^{++} \rightarrow {}^6\text{Li}^{+++} \bar{\nu}_e e^-$   ${}^{18}_{10}\text{Ne} \rightarrow {}^{18}_9\text{F} \nu_e e^+$

fraction thereof will exist.



Alain Blondel

## Where will this get us...

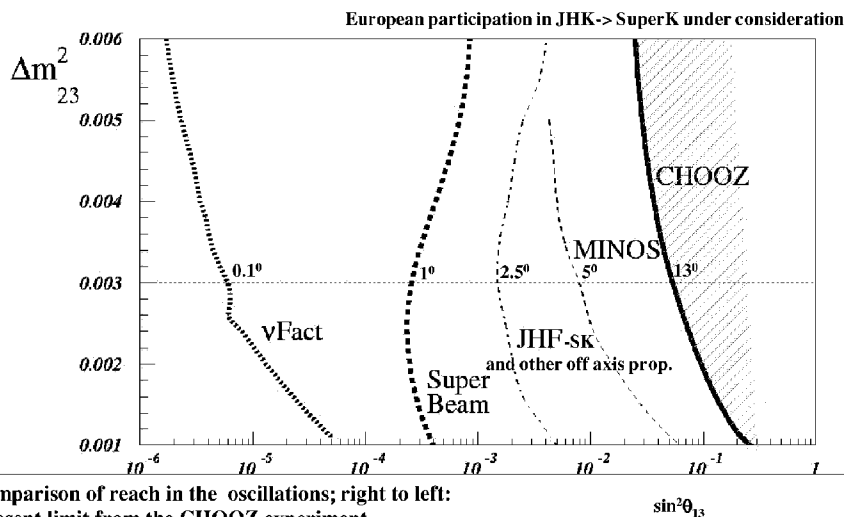

comparison of reach in the oscillations; right to left:  
 present limit from the CHOOZ experiment,  
 expected sensitivity from the MINOS experiment,  
 0.75 MW JHF to super Kamiokande with an off-axis narrow-band beam,  
 Superbeam: 4 MW CERN-SPL to a 400 kton water Cerenkov in Fréjus  
 from a Neutrino Factory with 40 kton large magnetic detector. INCLUDING SYSTEMATICS

## JHF → Super-Kamiokande

- ⌘ 295 km baseline
- ⌘ JHF approved
- ⌘ neutrino beam under discussion but set as first priority by international committee
- ⌘ Super-Kamiokande:
  - ☒ 22.5 kton fiducial
  - ☒ Excellent  $e/\mu$  ID --  $10^{-3}$
  - ☒ Additional  $\pi^0/e$  ID --  $10^{-2}$
  - ☒ (for  $E_\nu \sim 500$  MeV- 1 GeV)
- ⌘ Matter effects small
- ⌘ need near detector
- ⌘ European collaboration forming (UK(5)-Italy(5)-Saclay-Gva-SP(2))

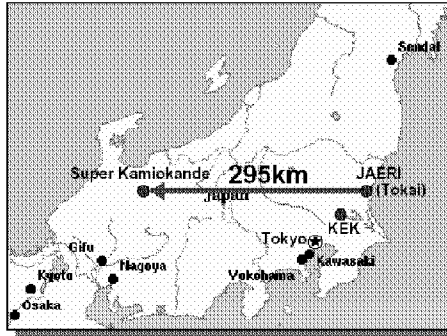

Alain Blondel 

Detector Phase I:  
the Super Kamiokande Detector

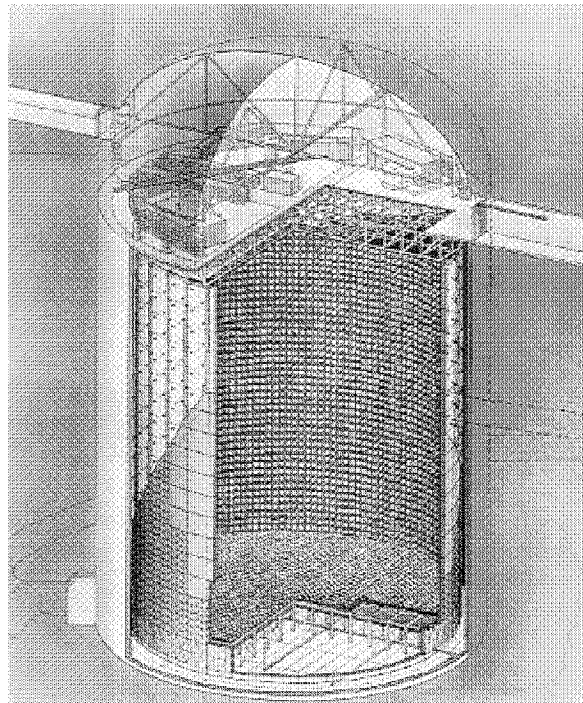

## $\mu/e$ Background Rejection

$e/\mu$  separation directly related to granularity of coverage.  
 Limit is around  $10^{-3}$  ( $\mu$  decay in flight) SKII coverage OKOK, less maybe possible

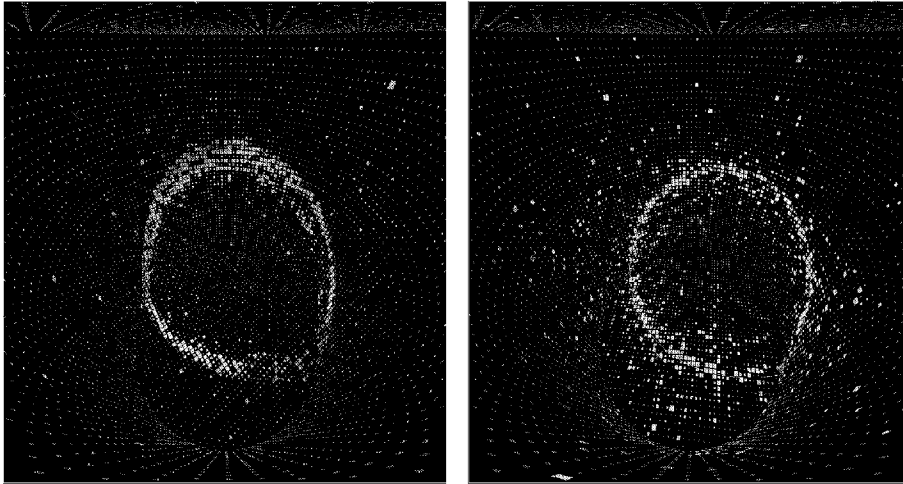

Alain Blondel

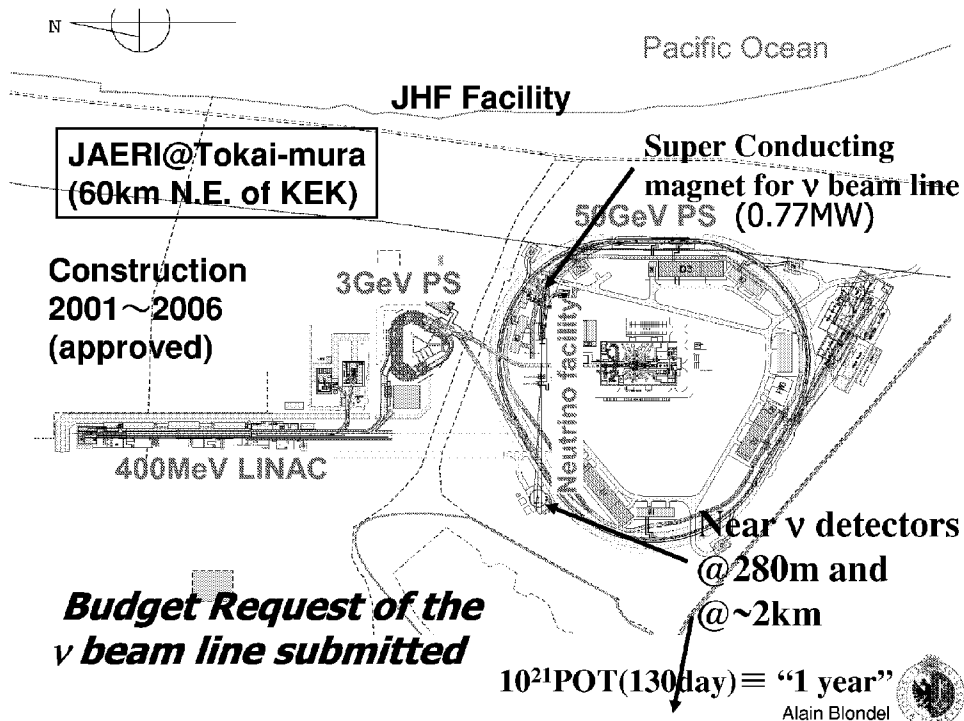



Off Axis Beam (another NBB option)  
(ref.: BNL-E889 Proposal)

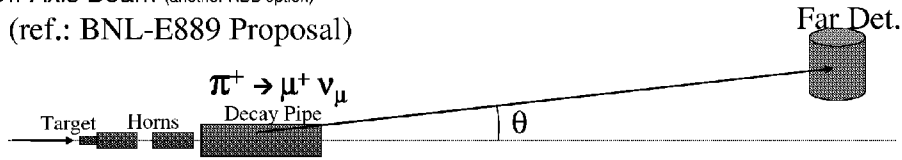

WBB w/ intentionally misaligned beam line from det. axis

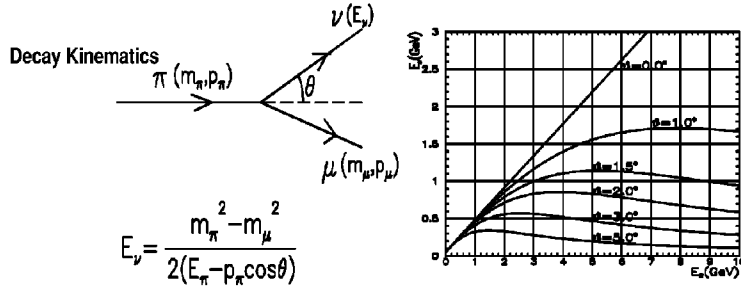

- ◆ Quasi Monochromatic Beam
- ◆ x2~3 intense than NBB

Alain Blondel

Two body decay kinematics: case of 734 km (NUMI)

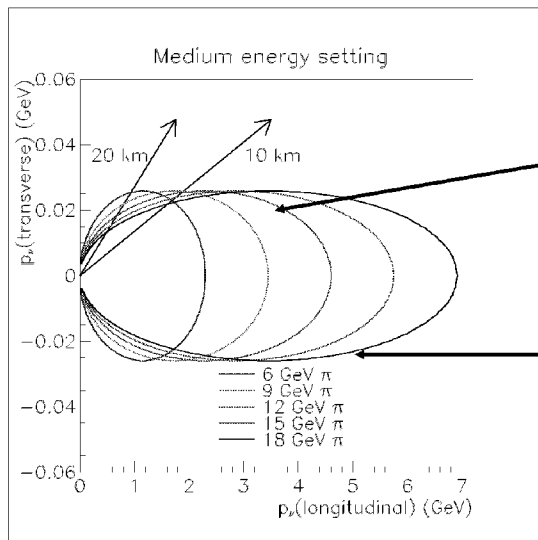

At this angle, 15 mrad,  
energy of produced  
neutrinos is 1.5-2 GeV  
for all pion energies →  
very intense, narrow  
band beam  
'On axis':  $E_\nu = 0.43 E_\pi$

$$p_L = \gamma(p^* \cos \theta^* + \beta E^*)$$

$$p_T = p^* \sin \theta^*$$

Alain Blondel

Expected spectrum

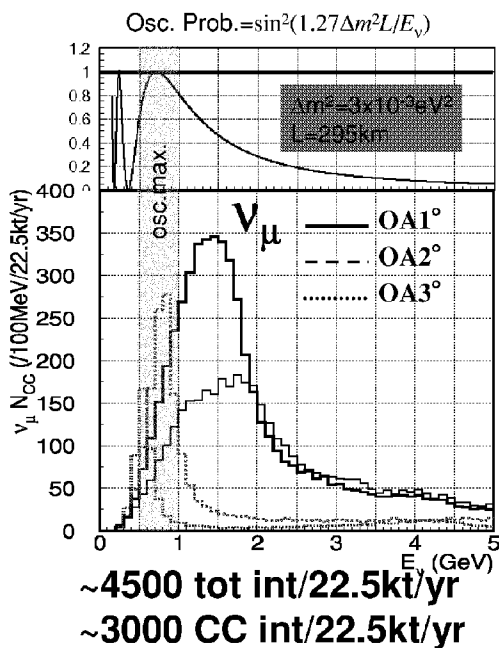

$\nu_e$  contamination

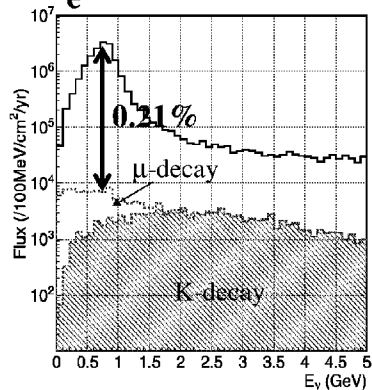

Very small  $\nu_e/\nu_\mu$   
@  $\nu_\mu$  peak

Alain Blondel

High intensity narrow band beam: Off-axis (OA) beam

$\nu_\mu$  flux from 50 GeV protons (JHF)

(ref.: BNL-E889 Proposal)

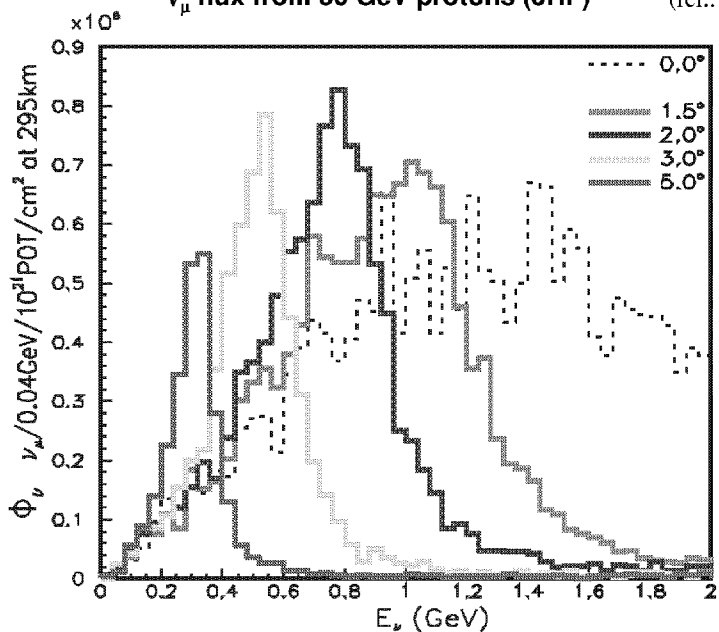

Increase statistics  
@ osc. max.

Decrease bkg  
from HE tail

Tunable by varying  
beam angle  
(or:  
detector position?)

Alain Blondel

### Detectors at near site

#### ⌘ Muon monitors @ ~140m

- ☒ Behind the beam dump
- ☒ Fast (spill-by-spill) monitoring of beam direction/intensity

#### ⌘ First Front detector "Neutrino monitor" @280m

- ☒ Intensity/direction
- ☒ Neutrino interactions

#### ⌘ Second Front Detector @ ~2km

- ☒ Almost same  $E_\nu$  spectrum as for SK
- ☒ Absolute neutrino spectrum
- ☒ Precise estimation of background
- ☒ Investigating possible sites

Neutrino spectra at diff. dist

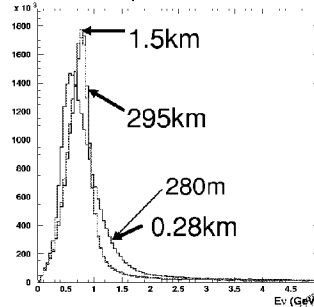

Alain Blondel



$\nu_e$  appearance (continue)

$$\sin^2 2\theta_{\mu e} = 0.05 \quad (\sin^2 2\theta_{\mu e} \equiv 0.5 \sin^2 2\theta_{13})$$

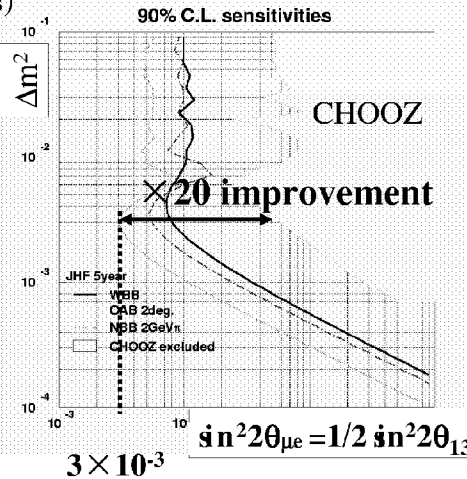
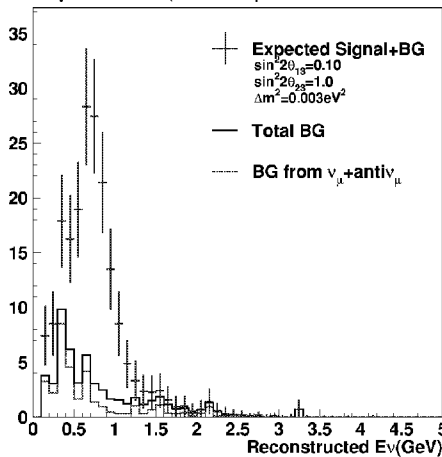

$$\sin^2 2\theta_{13} < 0.006 \quad (90\% \text{ C.L.})$$

Alain Blondel



Far detector in second phase

**Phase-II: Hyper-K  
1,000 kt**

**Phase-I: Super-K  
22.5kt (50kt)**

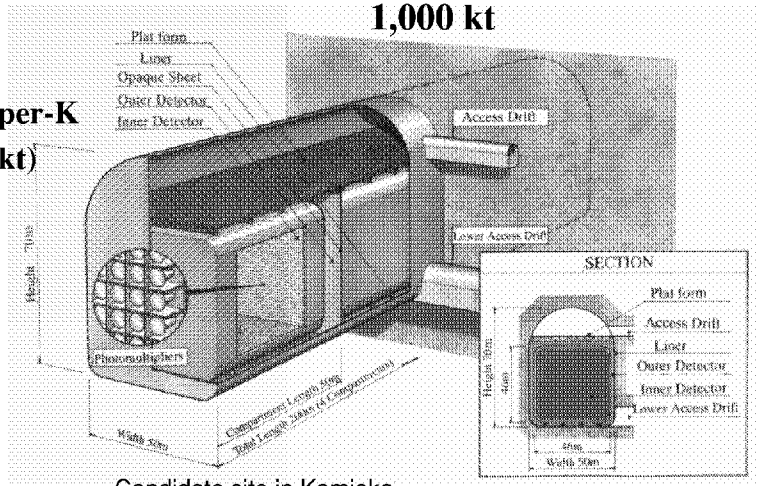

Candidate site in Kamioka

Other major goal: improve proton decay reach

Alain Blondel



**Decay pipe common for SK/HK**

Possible site for Hyper-K

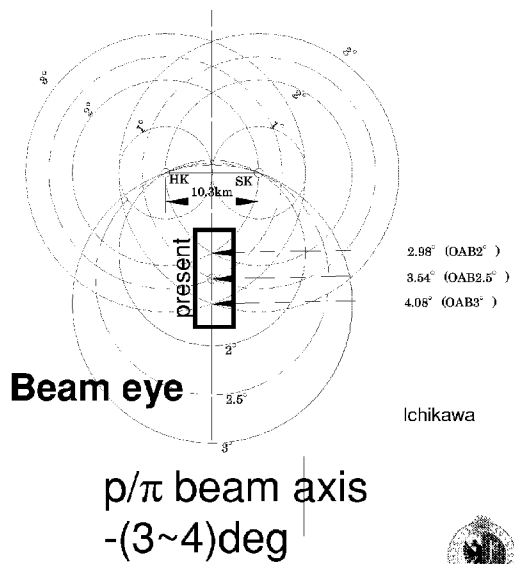
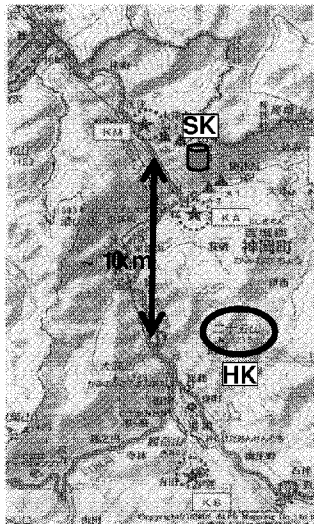

Alain Blondel



## -- Neutrino Factory -- CERN layout

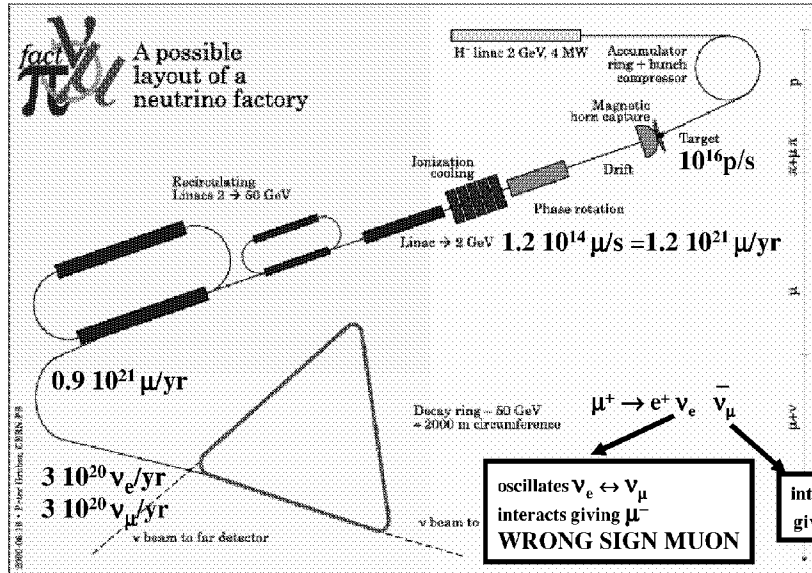

Alain Blondel



## Possible step 0: Neutrino SUPERBEAM

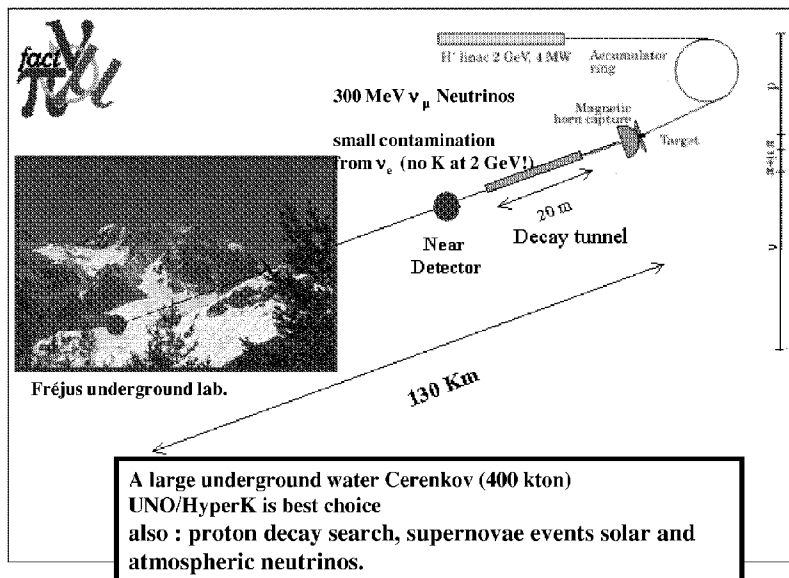

Alain Blondel



## Europe: SPL→Furejus

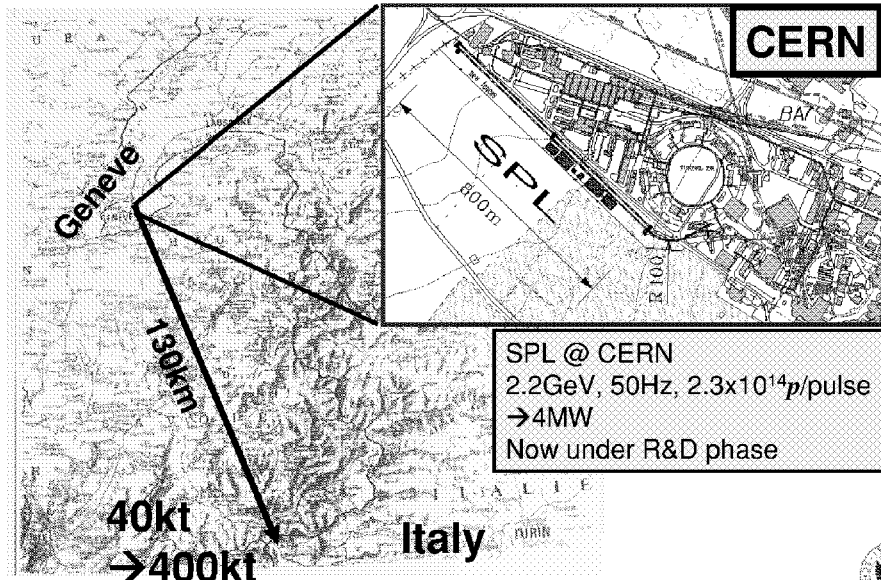

Alain Blondel

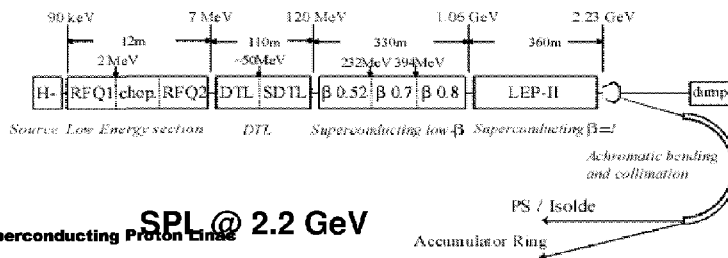

### ⌘ High power

- ☑ LINAC @ 4 MW
- ☑ Rep. Rate 50 Hz
- ☑  $2.27 \times 10^{14}$  p/pulse spaced by 22.7 nsec (44 MHz)

### ⌘ Reuse of LEPII cavities or cryostat (LEP IS NOT DEAD)

### ⌘ Single turn $\mu$ injection in storage ring (2000 m):

- ☑ proton burst  $< 6 \mu$ s → Linac 2.8 ms

- ☑ duty cycle for neutrino beam → Accumulator Needed

Alain Blondel



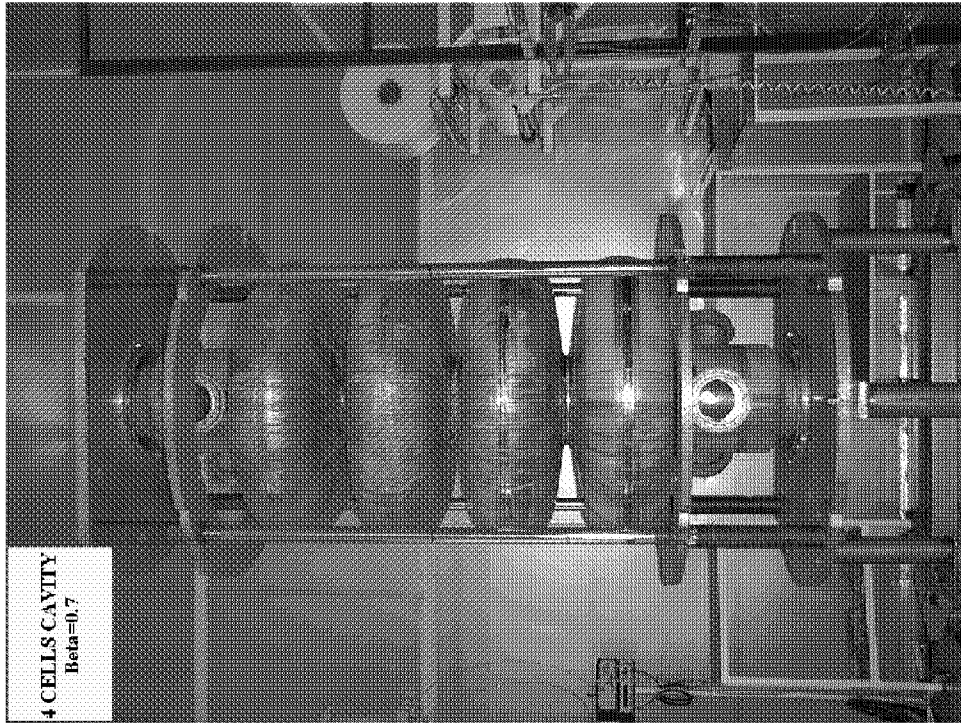

### Accumulator compressor scheme

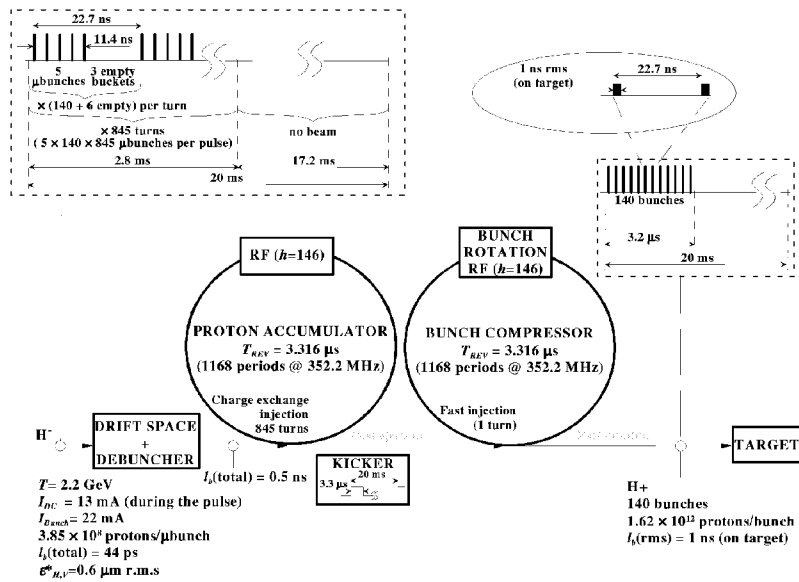

Alain Blondel







## Detectors

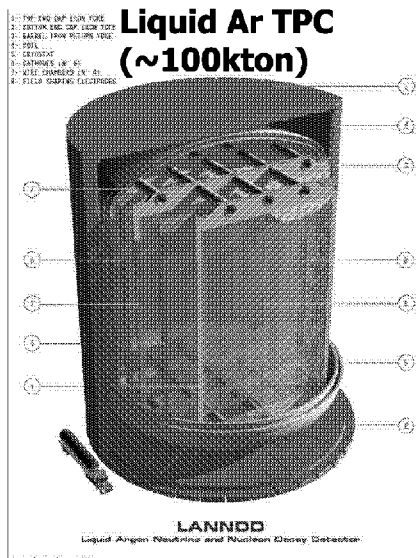

## UNO (400kton Water Cherenkov)

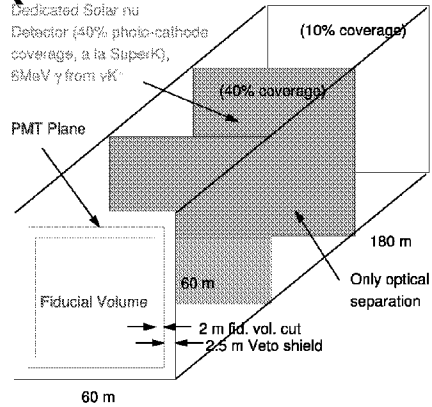

Alain Blondel



limit to the size of large underground Water Cherenkov detectors will be given by the difficulties of excavation.  
Max width is about 50-60 meters. => increase high&length

Far detector in second phase

## Phase-II: Hyper-K 1,000 kt

### Phase-I: Super-K 22.5kt (50kt)

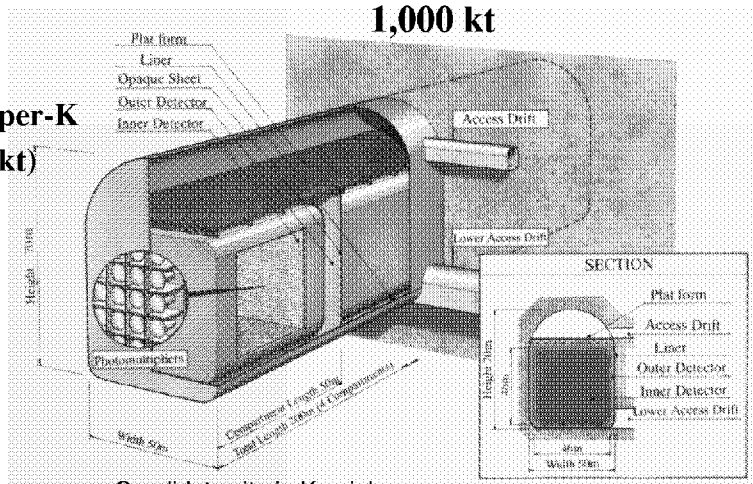
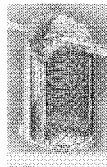

Candidate site in Kamioka

Other major goal: improve proton decay reach

Alain Blondel



## SPL neutrino beam

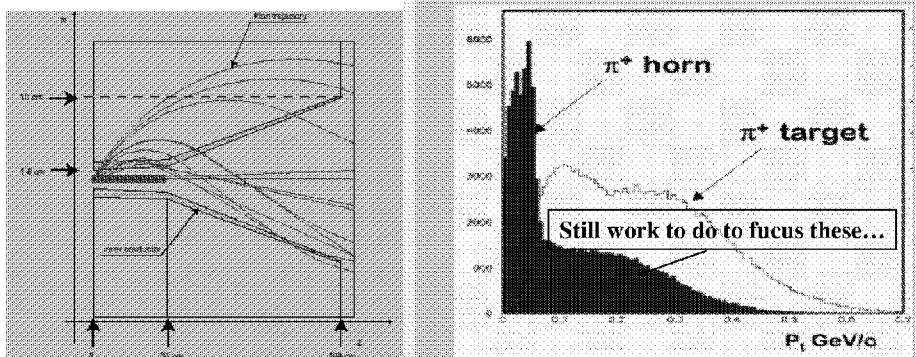

\* At 2 GeV, K production is very small  
 ⇒ Bkg of from  $\nu_e$  in the beam is small and dominated by muon decay  
 This can be tailored by varying the length of the decay tunnel and reduced to 0.3-0.4 % (all spectrum)

\* this is a low energy beam ( $\langle E_{\nu} \rangle = 300 \text{ MeV}$ )

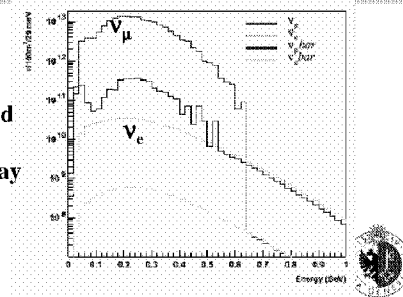

## $\mu/e$ Background Rejection

$e/\mu$  separation directly related to granularity of coverage.  
 Limit is around  $10^{-3}$  (mu decay in flight) SKII coverage OKOK, less maybe possible

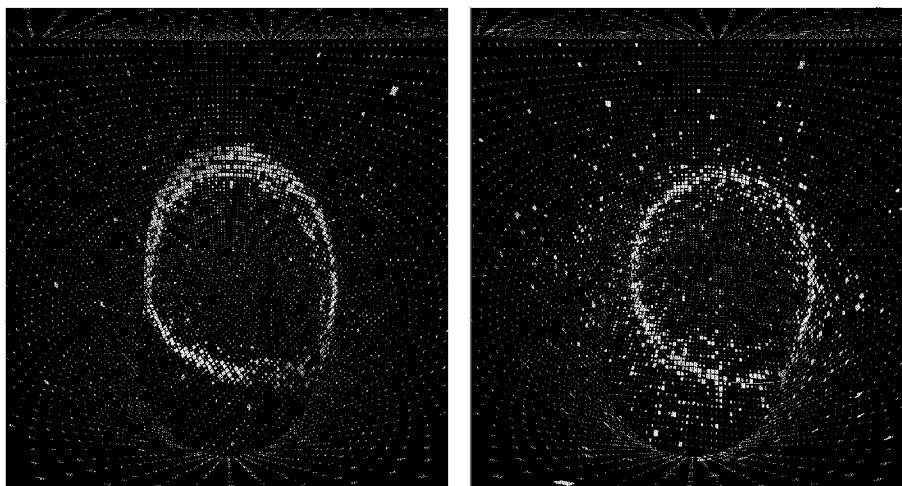

Alain Blondel



### $E_\nu$ reconstruction < 1GeV region

**CC quasi elastic reaction**  $\Leftrightarrow E_\nu = \frac{m_N E_\mu - m_\mu^2/2}{m_N - E_\mu + p_\mu \cos \theta_\mu}$

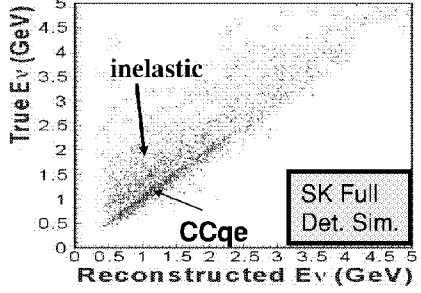
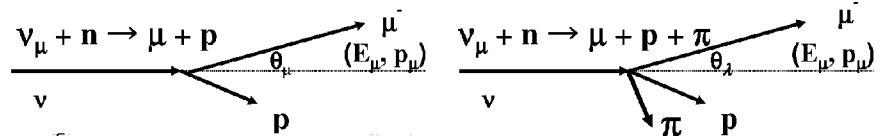

**Inelastic (BG)**

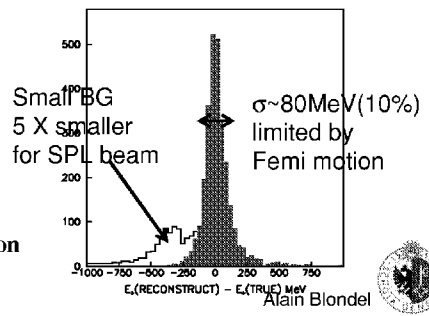

Energy can be well reconstructed => Bkg reduction  
 => precise measurement of osc. params  
 => SENSITIVITY SIMILAR TO JHF-> HyperK

### BETA Beam

new idea by P. Zucchelli

produce  ${}^6\text{He}^{++}$ , store, accelerate (100 GeV/u), store

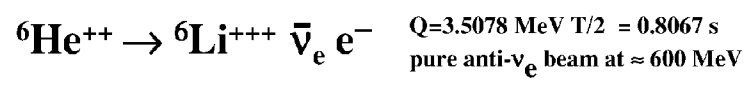

or:

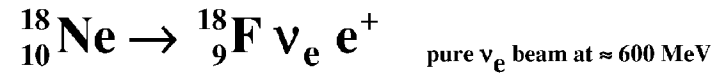

oscillation signal: appearance of low energy muons  
 no opposite charge neutrinos=> no need for magnetic detectors  
 little matter effects at these energies  
 water Cerenkov excellent for this too, same as for Superbeam.  
 seems feasible; but cost unknown so far.  
 Critical: duty cycle.

A nice \*\*\* idea to be followed up!  
 Alain Blondel

## B Anti-Neutrino Source

Consider  ${}^6\text{He}^{++} \rightarrow {}^6\text{Li}^{+++} + \bar{\nu}_e + e^-$

$E_0 = 3.5078 \text{ MeV}$   $T/2 = 0.8067 \text{ s}$

1. The ion is spinless, and therefore decays at rest are isotropic.
2. It can be produced at high rates, i.e.  $5 \times 10^{13} \text{ } {}^6\text{He}/\text{s}$
3. The neutrino spectrum is known on the basis of the electron spectrum.

B.M. Mustard and S.L. Ruby, Phys. Rev. 27 (1956) 391  
B.W. Foley, Nucl. Phys. 25 (1951) 433

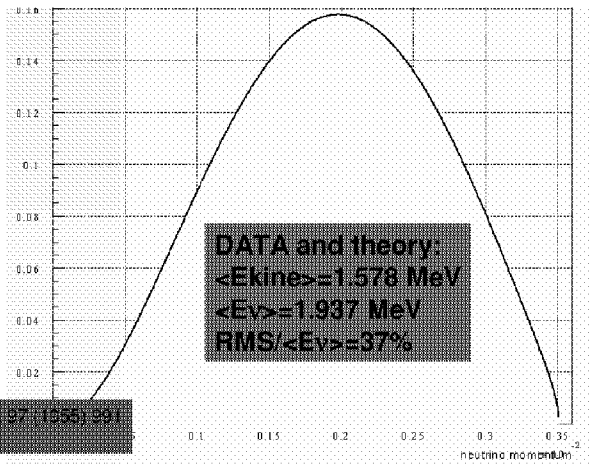
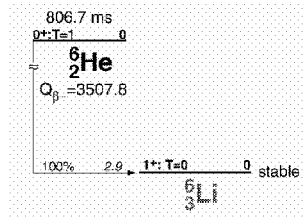

## B Neutrino Source

Possible neutrino emitter candidate:  ${}^{18}\text{Ne}$

The same technology used in the production of  ${}^6\text{He}$  is limited in the  ${}^{18}\text{Ne}$  case to  $10^{12}$  ions/s.

Dedicated R&D should increase this figure.

Use this intensity as reference.

Issues:

MgO less refractory  
heat dissipation

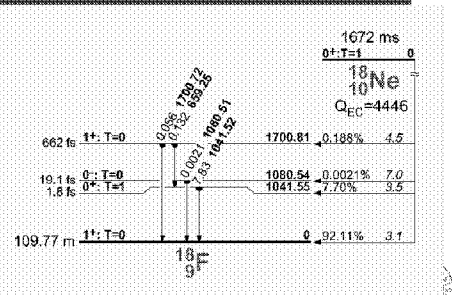

Alain Blondel

# Beta Beam

(P. Zucchelli)

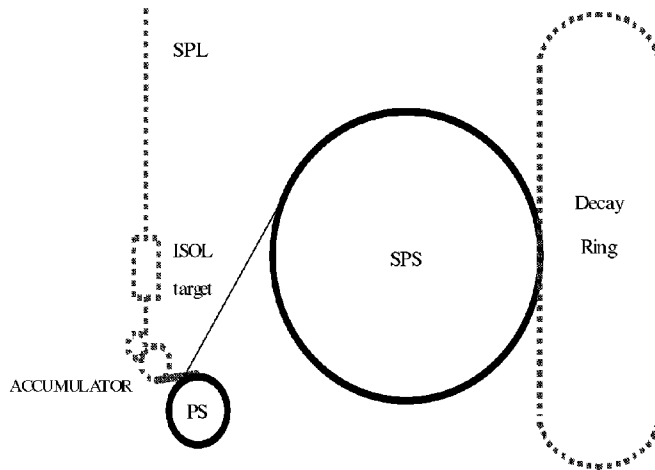

M. Lindroos et al.

Alain Blondel



## Combination of beta beam with low energy super beam

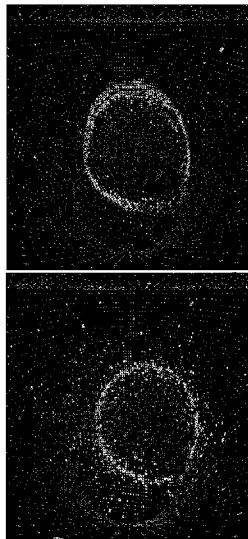

Unique to CERN:

need few 100 GeV accelerator (PS + SPS will do!)  
experience in radioactive beams at ISOLDE

many unknowns: what is the duty factor that can be achieved? (needs  $< 10^{-3}$ )

combines CP and T violation tests

$$\nu_e \rightarrow \nu_\mu \quad (\beta^+) \quad (T) \quad \nu_\mu \rightarrow \nu_e \quad (\pi^+)$$

(CP)

$$\bar{\nu}_e \rightarrow \bar{\nu}_\mu \quad (\beta^-) \quad (T) \quad \bar{\nu}_\mu \rightarrow \bar{\nu}_e \quad (\pi^-)$$

Can this work???? theoretical studies now on beta beam  
+ SPL target and horn R&D revue at NUFACT02 (1-6 July 2002)

Alain Blondel



# E

## Superbeam & Beta Beam cost estimates

Educated guess on possible costs	USD/CHF	1.60
UNO	960	MCHF
SUPERBEAM LINE	100	MCHF
SPL	300	MCHF
PS UPGR.	100	MCHF
SOURCE (EURISOL), STORAGE RING	100	MCHF
SPS	5	MCHF
DECAY RING CIVIL ENG.	400	MCHF
DECAY RING OPTICS	100	MCHF
TOTAL (MCHF)	2065	MCHF
TOTAL (MUSD)	1291	MUSD
INCREMENTAL COST (MCHF)	705	MCHF
INCREMENTAL COST (MUSD)	441	MUSD

Alain Blondel



### The neutrino mixing matrix: 3 angles and a phase $\delta$

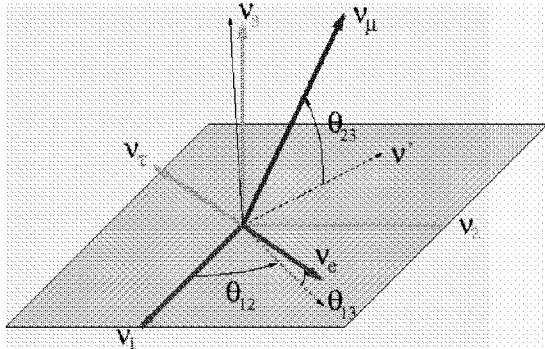

$\theta_{23}$  (atmospheric) =  $45^\circ$ ,  $\theta_{12}$  (solar) =  $30^\circ$ ,  $\theta_{13}$  (Chooz) <  $13^\circ$

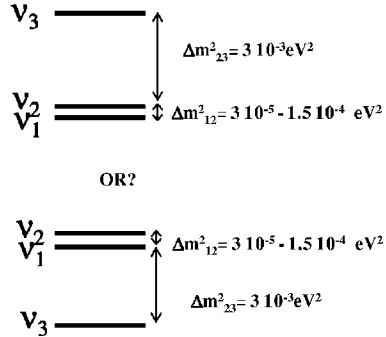

$$U_{MNS} = \begin{pmatrix} \sim \frac{\sqrt{2}}{2} & \sim -\frac{\sqrt{2}}{2} & \sin \theta_{13} e^{i\delta} \\ \sim \frac{1}{2} & \sim \frac{1}{2} & \sim -\frac{\sqrt{2}}{2} \\ \sim \frac{1}{2} & \sim \frac{1}{2} & \sim \frac{\sqrt{2}}{2} \end{pmatrix}$$

Unknown or poorly known  
even after approved program:  
 $\theta_{13}$ , phase  $\delta$ , sign of  $\Delta m^2_{13}$

Alain Blondel



### -- Neutrino Factory -- CERN layout

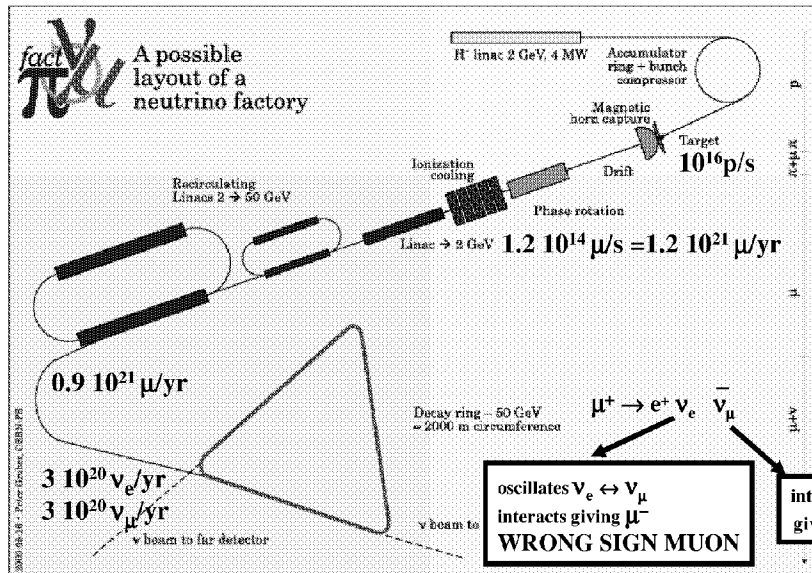

oscillates  $\nu_e \leftrightarrow \nu_\mu$   
interacts giving  $\mu^-$   
**WRONG SIGN MUON**

interacts  
giving  $\mu^+$

Alain Blondel



## Scaling laws

Event numbers in a neutrino beam (at long distance the beam is much larger than the detector)

$$N_{\text{events}} = \sigma [\text{cm}^2] \Phi [\text{v/cm}^2] A [\text{cm}^2] L [\text{cm}] d [\text{g/cm}^3] \cdot \mathcal{N}_{\text{Avogadro}} [\text{nucleons/g}]$$

$$\sigma \sim 0.7 \cdot 10^{-38} E_V [\text{GeV}] \text{ cm}^2/\text{GeV} \quad \text{scales with energy } E$$

$$\text{flux scales as } 1/\theta^2 L^2 \sim E_{\text{parent}}^2 / L^2$$

$$\rightarrow \text{number of events scales as } E_{\text{parent}}^3 / L^2$$

Oscillation goes as  $\sin^2(1.27 \Delta m^2 L/E)$  this scales as  $L^2/E^2$  in the first oscillation. (note  $L^2$  dependence goes - for signal!)

Events -- and sensitivity in absence of background -- go like  $E_{\text{parent}}$

In case of background, sensitivity goes like  $S/\sqrt{B}$  and  $B$  goes like  $E^3/L^2$



## Neutrino fluxes $\mu^+ \rightarrow e^+ \nu_e \nu_\mu$

$\nu_\mu/\nu_e$  ratio reversed by switching  $\mu^+/\mu^-$   
 $\nu_e \nu_\mu$  spectra are different  
 No high energy tail.

**Very well known flux ( $\pm 10^{-3}$ )**

-- E& $\sigma_E$  calibration from muon spin precession

-- angular divergence: small effect if  $\theta < 0.2/\gamma$ ,

- absolute flux measured from muon current  
 or by  $\nu_\mu e^- \rightarrow \mu^- \nu_e$  in near expt.

-- in triangle ring,

muon polarization precesses and averages out  
 (preferred,  $\rightarrow$  calib of energy, energy spread)

-- in Bow-tie ring,

muon polarization stays constant, no precession

20% easy  $\rightarrow$  40% hard

Must be measured!!!! (precision?)

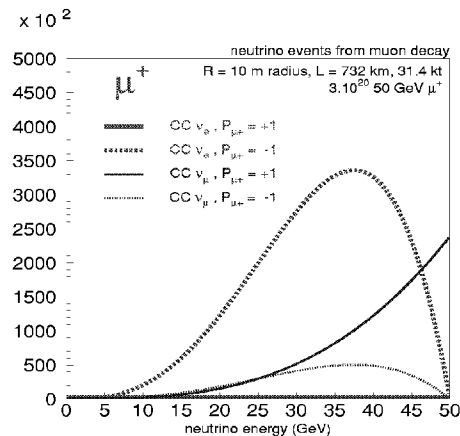

$\mu$  polarization controls  $\nu_e$  flux:

$\mu^+ \rightarrow e^+ \nu_e$  in forward direction

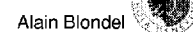



$$\mu^+ \rightarrow e^+ \nu_e \bar{\nu}_\mu$$

Expected Physics outcome of a Long base Line program  
at a Neutrino factory

High energy  $\nu_e$  essential & unique

• Measurements of

$\theta_{13}, \theta_{23}$  with precision of  $10^{-3}$  or limit at about  $10^{-6}$   
 $\Delta m_{13}$  with relative precision of 1%

• establish matter effect  $\rightarrow$  sign of  $\Delta m_{13}$

• Will be sensitive to CP violation over the whole  
Large Mixing Angle solution of the Solar neutrinos (now  
established)

• (50 KT, 5 years,  $10^{21}$  muons per year stored, 3000 km)

Alain Blondel



Golden

MEASUREMENTS at V- FACTORY

$$\bar{\nu}_e \leftrightarrow \bar{\nu}_{\mu,\tau}$$

$\bar{\nu}_e \rightarrow \bar{\nu}_\mu$  is the golden measurement at Nufact:  
appearance of wrong-sign muons

$$\begin{array}{ccc} \mu^- \rightarrow \nu_\mu & \bar{\nu}_e & e^- \\ & \downarrow & \\ & \bar{\nu}_\mu & \rightarrow \mu^+ \\ \mu^+ \rightarrow \bar{\nu}_\mu & \nu_e & e^+ \\ & \downarrow & \\ & \nu_\mu & \rightarrow \mu^- \end{array}$$

Alain Blondel



## Detector

- ⌘ Iron calorimeter
- ⌘ Magnetized
  - ☑ Charge discrimination
  - ☑  $B = 1 \text{ T}$
- ⌘  $R = 10 \text{ m}, L = 20 \text{ m}$
- ⌘ Fiducial mass = 40 kT

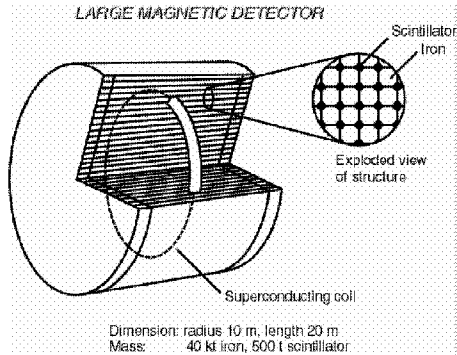

Also: L Arg detector: magnetized ICARUS  
Wrong sign muons, electrons, taus and NC evts \* ->

Baseline	$\bar{\nu}_\mu \text{ CC}$	$\nu_e \text{ CC}$	$\nu_\mu \text{ signal } (\sin^2 \theta_{13}=0.01)$
732 Km	$3.5 \times 10^7$	$5.9 \times 10^7$	$1.1 \times 10^5$
3500 Km	$1.2 \times 10^6$	$2.4 \times 10^6$	$1.0 \times 10^5$

Alain Blondel

6 classes of events

- right sign muon  $\bar{\nu}_\mu \rightarrow \bar{\nu}_\mu \rightarrow \mu^+$
- electron/positron  $\bar{\nu}_\mu \rightarrow \bar{\nu}_e \rightarrow e^+$  or  $\nu_e \rightarrow \nu_e \rightarrow e^-$
- wrong sign muon  $\nu_e \rightarrow \bar{\nu}_\mu \rightarrow \mu^-$
- right sign tau  $\bar{\nu}_\mu \rightarrow \bar{\nu}_\tau \rightarrow \tau^+ \rightarrow \mu^+ \nu\nu$
- wrong sign tau  $\nu_e \rightarrow \nu_\tau \rightarrow \tau^- \rightarrow \mu^- \nu\nu$
- no lepton NC & other taus

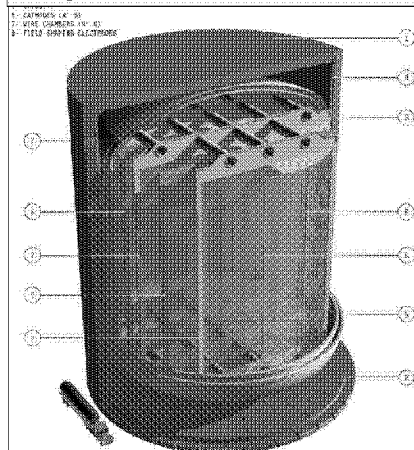

Bueno, Campanelli, Rubbia: hep-ph/0005000  
Simulated distributions for a 10kt Lar detector  
at  $L = 7400 \text{ km}$  from a 30 GeV nu-factory with  
 $Q^2 \mu^+$  decays.

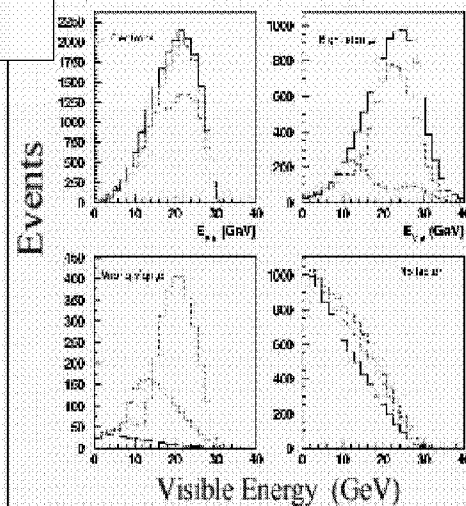

Alain Blondel

# ICARUS

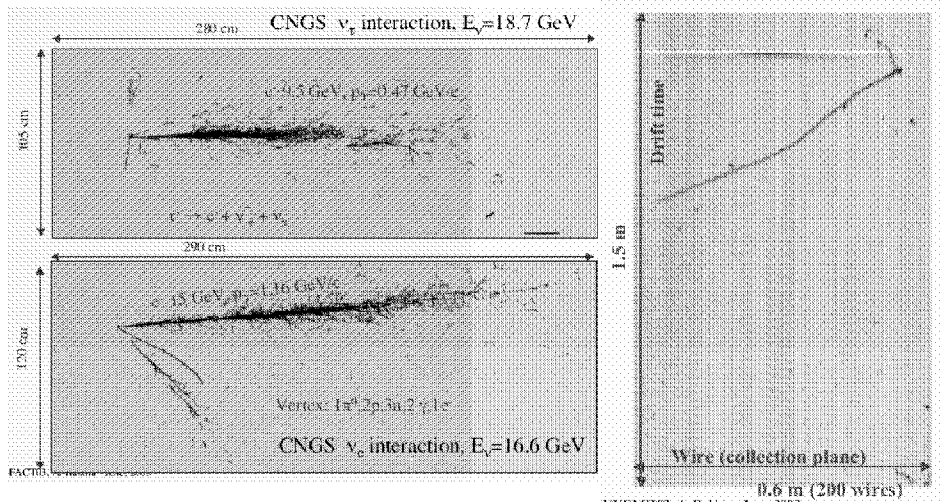

NB: additional potential wrt magnetized iron calorimeter:  
 tau detection, sign of \*low\* energy electrons, if magnetized.  
 May redefine the optimal parameters of neutrino factory

Alain Blondel

## Advantages of Liquid argon detector:

- see everything charged → extraordinary amount of information
- excellent pattern recognition
- for limited magnetic field (about 0.5-1 T) can tell charge of muons down to low energy
- can also tell the charge of low energy electrons ( $E < \sim 2 \text{ GeV}$ )

## Limitations:

- which mass can be reasonably build with a magnetic field?
- at which cost?
- safety issues in an underground environment?
- decay background on wrong sign muons will be larger.

Interesting R&D ahead...

Alain Blondel

### Event rates

$$N_{\mu^+\mu^-} = 10^{23} / y, M_{det} = 40 \text{ KTon y}, E_{\mu} = 50 \text{ GeV}$$

$\mu^-$  beam

Baseline	$\bar{\nu}_e$ CC	$\nu_\mu$ CC	$\mu^+(10^\circ)$	$\mu^+(0.5^\circ)$
732 Km	$3 \cdot 10^7$	$6.9 \cdot 10^7$	$1.7 \cdot 10^4$	44
3500 Km	$1.3 \cdot 10^6$	$3 \cdot 10^6$	$7 \cdot 10^3$	15
7332 Km	$3 \cdot 10^5$	$6.9 \cdot 10^5$	$2.8 \cdot 10^2$	1

$\mu^+$  beam

Baseline	$\nu_e$ CC	$\bar{\nu}_\mu$ CC	$\mu^-(10^\circ)$	$\mu^-(0.5^\circ)$
732 Km	$5.9 \cdot 10^7$	$3.5 \cdot 10^7$	$3.6 \cdot 10^4$	94
3500 Km	$2.5 \cdot 10^6$	$1.5 \cdot 10^6$	$3.1 \cdot 10^3$	85
7332 Km	$5.9 \cdot 10^5$	$3.5 \cdot 10^5$	$1.2 \cdot 10^3$	39

NB: oscillation signal is nearly indept of distance

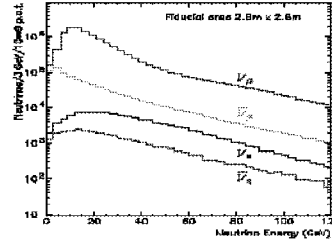
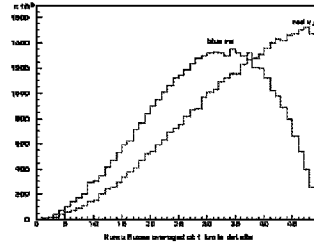

conventional neutrino beam from  $\pi, K$  decay:  
long high energy tail,  
Bkg from  $\nu_e$  and NC events

NUFACT = 100 X CNGS with **2** Flavours,  
No high energy tail to produce NC with  $\pi^0$

Alain Blondel

## Signal Rates & Signal/Background

Note: backgrounds for  $\nu_e \rightarrow \nu_\mu$  measurements (wrong-sign muon appearance) are much easier to suppress than backgrounds to  $\nu_\mu \rightarrow \nu_e$  measurements (electron appearance).

Many groups have calculated signal & background rates. Recent example  
*Hubner, Lindner & Winter; hep-ph/0204352*

JHF-SK:	Beam = 0.75 MW, $M_{fid} = 22.5 \text{ kt}$ , T = 5 yrs
JHF-HK:	Beam = 4 MW, $M_{fid} = 1000 \text{ kt}$ , T = 8 yrs
Entry-Level NUFAC:	Beam = $1 \times 10^{19}$ decays/yr, $M_{fid} = 100 \text{ kt}$ , T = 5 yrs
High-Performance NUFAC:	Beam = $2.6 \times 10^{20}$ decays/yr, $M_{fid} = 100 \text{ kt}$ , T = 8 yrs

$$\Delta m_{21}^2 = 0.003 \text{ eV}^2, \Delta m_{31}^2 = 3.7 \times 10^{-5} \text{ eV}^2, \sin^2 2\theta_{23} = 1, \sin^2 2\theta_{13} = 0.1, \sin^2 2\theta_{12} = 0.8, \delta = 0$$

	Superbeams		Neutrino Factories	
	JHF-SK	JHF-HK	Entry Level	High Performance
Signal	140	13000	1500	65000
Background	23	2200	4.2	180
S/B	6		360	

Alain Blondel

## Sensitivity to $\sin^2\theta_{13}$

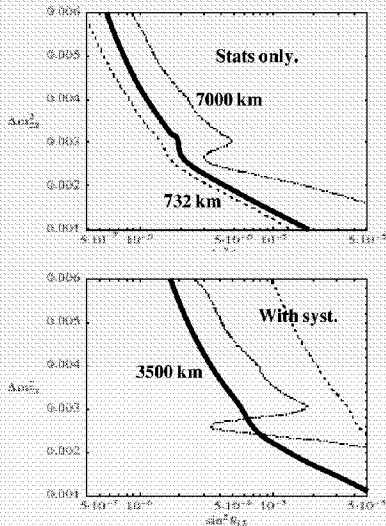

$N_{\nu(\mu)}$  =  $10^{21}$ /year,  $M_{det}$  = 40 KTon year

Appearance of wrong sign muons.  
Background very low in dense detector  
(mostly comes from very inelastic charm production)  
Can be kept at a few  $10^{-5}$  level by cuts on  
Muon momentum, Pt, and Pt w.r.t. hadronic shower

$N_{CC}$  events

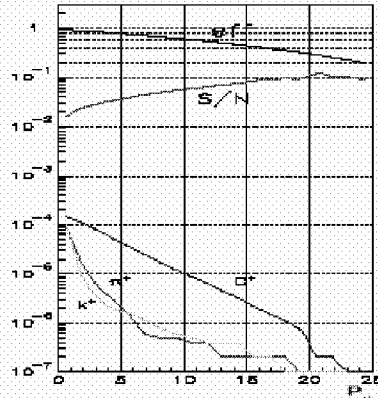

## CP asymmetries compare $\nu_e \rightarrow \nu_\mu$ to $\bar{\nu}_e \rightarrow \bar{\nu}_\mu$ probabilities

$$P_{\nu_e \rightarrow \nu_\mu} = \sin^2 \theta_{23} \sin^2 2\theta_{13} \left( \frac{\Delta m_{21}^2}{\mu} \right)^2 \sin^2 B_{\pm} L$$

$$\text{with } B_{\pm} \equiv \sqrt{(\Delta m_{23}^2 \cos 2\theta_{13} \pm \mu)^2 + (\Delta m_{23}^2 \sin 2\theta_{13})^2}$$

$\mu$  is prop matter density, positive for neutrinos, negative for antineutrinos

$$A = \frac{\mu^- / \nu_e - \mu^+ / \bar{\nu}_e}{\mu^- / \nu_e + \mu^+ / \bar{\nu}_e}$$

HUGE effect for distance around 6000 km!!  
Resonance around 12 GeV when

$$\Delta m_{23}^2 \cos 2\theta_{13} \pm \mu = 0$$

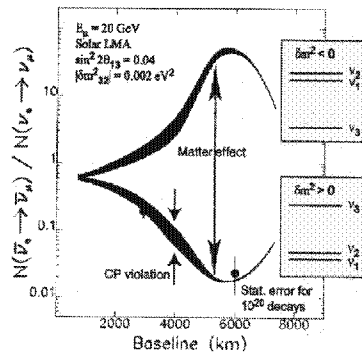

Alain Blondel



# CP violation (ctd)

Matter effect must be subtracted. One believes this can be done with uncertainty Of order 2%. Also spectrum of matter effect and CP violation is different  
 =>It is important to subtract in bins of measured energy.  
 =>knowledge of spectrum is essential here!

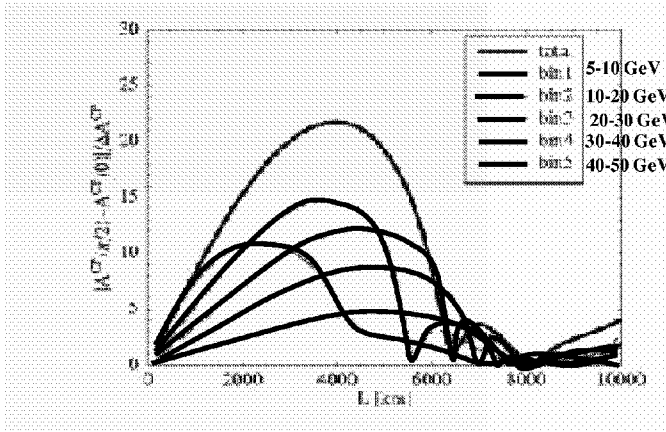

40 kton L M D  
 50 GeV nuFact  
 5 yrs  $10^{21} \mu$ /yr

In fact, 20-30 GeV  
 Is enough!

Best distance is  
 2500-3500 km

e.g. Fermilab or BNL  
 -> west coast or ...

Alain Blondel



# Silver channel at neutrino factory

A. Donini et al  
 hep-ph/0208034  
 ROMA-1336/02

High energy neutrinos at NuFact allow observation of  $\nu_e \rightarrow \nu_\tau$   
 (wrong sign muons with missing energy and  $P_\perp$ ). UNIQUE

Liquid Argon or OPERA-like detector at 3000 km.

Since the  $\sin\delta$  dependence has opposite sign with the wrong sign muons, this solves ambiguities that will invariably appear if only wrong sign muons are used.

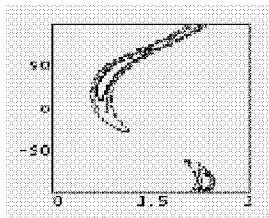

ambiguities with  
 only wrong sign muons (3500 km)

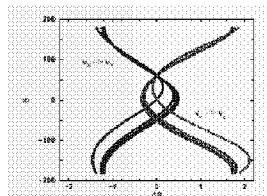

equal event number curves  
 muon vs taus

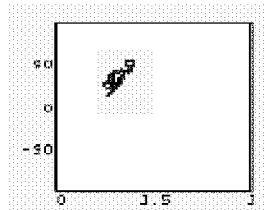

associating taus to muons  
 (no efficiencies, but only OPERA mass)  
 studies on-going

Alain Blondel



**Why do we believe that the  
neutrino fluxes  
can be determined to  $\pm 10^{-3}$   
at a Neutrino Factory?**

**Flux Control and Resulting Constraints on the Decay Ring Design**

**source: M. Apollonio et al,  
OSCILLATION PHYSICS WITH A NEUTRINO FACTORY  
arXiv: hep-ph/0210192 v1 13 Oct 2002**

Alain Blondel

**why?**

In the high intensity scenario

- the event rates in the far detector are above  $10^9$ /yr/Mton  
→ precision measurement of the mixing angle and mass differences.
- 2. the event rates in the near detectors are at the level of  $10^8$ /yr/kg
  - precision measurements of total cross-sections
  - structure functions
  - SM tests etc...

Alain Blondel

## Neutrino fluxes $\mu^+ \rightarrow e^+ \nu_e \nu_\mu$

$\nu_\mu/\nu_e$  ratio reversed by switching  $\mu^+/\mu^-$   
 $\nu_e \nu_\mu$  spectra are different  
 No high energy tail.

### Very well known flux (aim is $10^{-3}$ )

- absolute flux measured from muon current or by  $\nu_\mu e^- \rightarrow \mu^- \nu_e$  in near expt.
- in triangle ring, muon polarization precesses and averages out (preferred, -> calib of energy, energy spread)
- E& $\sigma_E$  calibration from muon spin precession
- angular divergence: small effect if  $\theta < 0.2/\gamma$ , can be monitored

- in Bow-tie ring, muon polarization stays constant, no precession
- 20% easy -> 40% hard
- Must be measured!!!! (precision?)

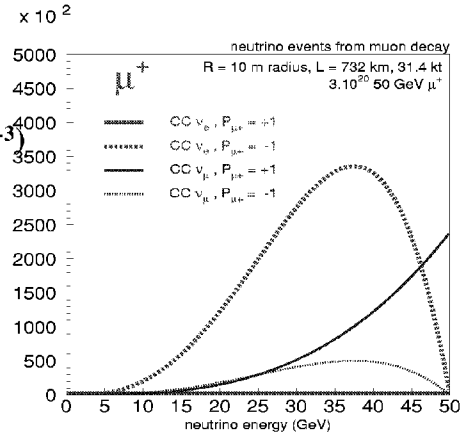

$\mu$  polarization controls  $\nu_e$  flux:  
 $\mu^+ \rightarrow e^+ \nu_e$  in forward direction

Alain Blondel



System where one stores a beam of decaying particles  
 Neutrino Factory, (and Beta Beam?)

⇒ potential for excellent neutrino flux control

### Main parameters to MONITOR

1. Total number of muons circulating in the ring,
2. muon beam polarisation,
3. muon beam energy and energy spread,
4. muon beam angle and angular divergence.
5. Theory of  $\mu$  decay, including radiative effects

Beam shape parameters are crucial for:

the measurement of oscillation length (i.e.  $\Delta m^2$ )

Absolute normalisation is essential for

the measurement of the mixing angles.

The relative normalisation of the two muon charges crucial for:

CP asymmetries.

Alain Blondel





Absolute number of muons in the ring: maybe the most difficult?

Total beam current: Beam Current Transformer

-- difficulties:

1. presence of decay electrons in the ring?

*Keil CERN-NUFACT Note 54 (2000), showed that the electrons are swept in the arcs and destroyed. Since the lifetime is 200 turns, the maximum fraction of electrons is  $0.3/200 = 1.6 \cdot 10^{-3}$  at the **end** of a straight section, much less at the entrance of it.*

→ Monitor should be placed at entrance of straight section.

2. absolute calibration?  $10^{-3}$  difficult, not impossible.

3. the most practical way to cross-normalize  $\mu^+$  vs  $\mu^-$  fluxes

alternative: count the electrons at the exist of a straight.

this has a nice feature of counting the decays!

the acceptance of the monitor (see polarimeter later) is tricky

Alain Blondel



Absolute normalisation (ctd)

-- Near detector will measure product of flux X cross-section

-- better:  $\nu_{\mu} e^- \rightarrow \mu^- \nu_e$  in a dedicated near detector.

type of detector:

ring imagind water cerenkov,

LA detector,

pressurized gas detector.

small mass is enough as rates are high but cross-section is quite small. ( $10^4$  ev/kg/yr. → need 100 kg.)

Main problem is determination of fiducial mass.

This provides an absolute normalization of the flux in the same way as bhabha scattering in  $e^+e^-$  colliders.

Limitations: threshold (11 GeV) & only for  $\mu^-$  stored beam

alternative is  $\nu_x e^- \rightarrow \nu_x e^-$  (assumes SM)

Alain Blondel



## Muon polarization

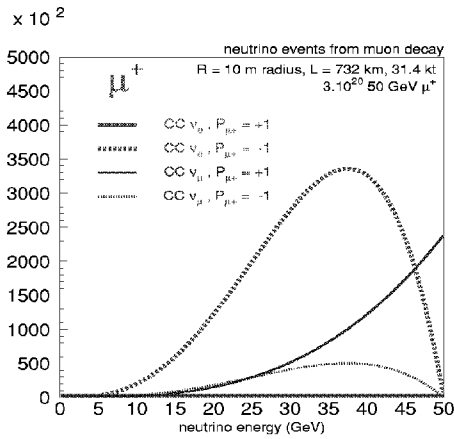

Has a large effect on the flux!  
 $\nu_e$  flux varies by 100%  
 when  $P$  goes from  $-1$  to  $+1$

$\mu$  polarization controls  $\nu_e$  flux:  
 $\mu^+ \rightarrow \nu_e$  in forward direction



## Muon Polarization

muons are born longitudinally polarized in pion decay (~18%)  
 depolarization is small (Fernow & Gallardo)

effect in electric and magnetic field is (mostly) described by spin tune:

$$\nu = a_\mu \gamma = \frac{g_\mu - 2}{2} \frac{E_{\text{beam}}}{m_\mu} = \frac{E_{\text{beam}}(\text{GeV})}{90.6223(6)}$$

which is small: at each kick  $\theta$  of a 200 MeV/c muon the polarization is kicked by  $\nu \cdot \theta = 0.002 \theta$

in the high energy storage ring polarization precesses. Interestingly  $\nu = 0.5$  for a beam energy of 45.3112 GeV: at that energy it flips at each turn.



## Muon Polarization

muon polarization is too small to be very useful for physics

(AB, Campanelli) but it must be monitored.

In addition it is precious for energy calibration (Raja&Tollestrup, AB)

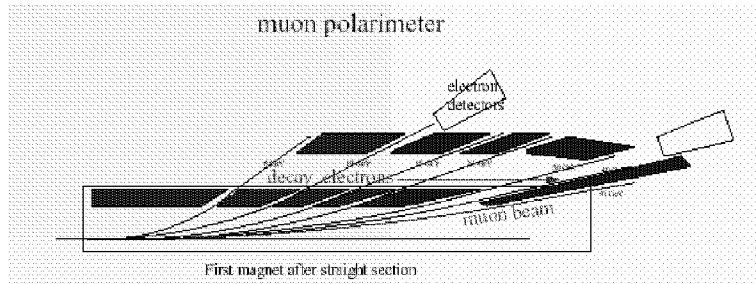

a muon polarimeter would perform the momentum analysis of the decay electrons at the end of a straight section.

Because of parity violation in muon decay the ratio of high energy to low energy electrons is a good polarization monitor.

Alain Blondel



## muon polarization

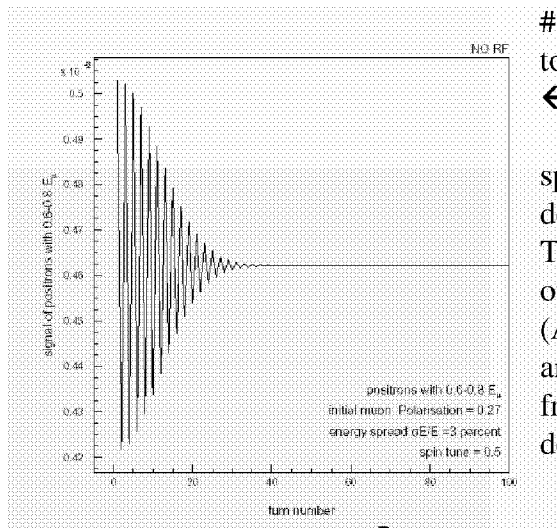

here is the ratio of

# positrons with  $E$  in  $[0.6-0.8] E_{\mu}$

to number of muons in the ring.

← There is no RF in the ring.

spin precession and

depolarization are clearly visible

This is the Fourier Transform

of the muon energy spectrum

(AB)

amplitude  $\Rightarrow$  polarization

frequency  $\Rightarrow$  energy

decay  $\Rightarrow$  energy spread.

$\rightarrow \Delta E/E$  and  $\sigma E/E$  to  $10^{-6}$

$\rightarrow$  polarization to a few percent.

Alain Blondel



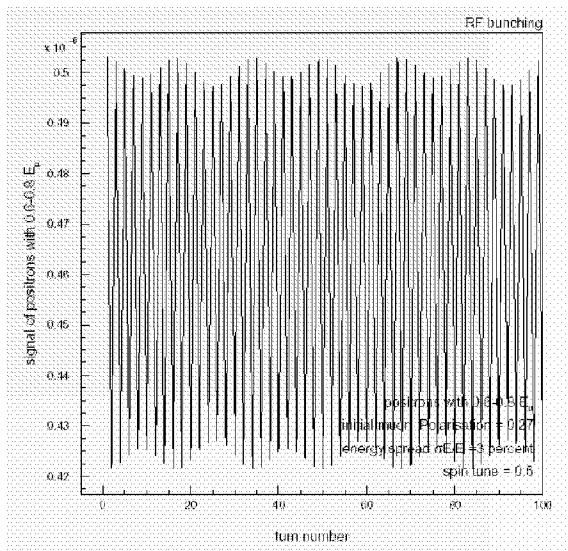

If there is RF in the storage ring to keep the muons bunched, depolarization is suppressed. (synchrotron oscillations)

Even in this case, the muon polarization, averaged over  $\sim 500$  turns is very small ( $\ll 0.18/500 = 4 \times 10^{-4}$ ) and will be monitored.

Alain Blondel 

### muon polarization: triangle or bow-tie?

This was true for a race track or triangle decay ring, in which polarization precesses.

A bow-tie has been suggested to avoid this spin precession and depolarization (net bend is zero, so muon polarization does not precess either)

This has several inconvenients:

- P is different for the two straights (who shall be pleased?)
- P cannot be reversed
- E and  $\sigma(E)$  can no longer be measured
- in order to know the flux to 0.1% on must know P to 0.1% and this is hard!

**end of the bow tie.**

Alain Blondel 

CERN baseline scenario

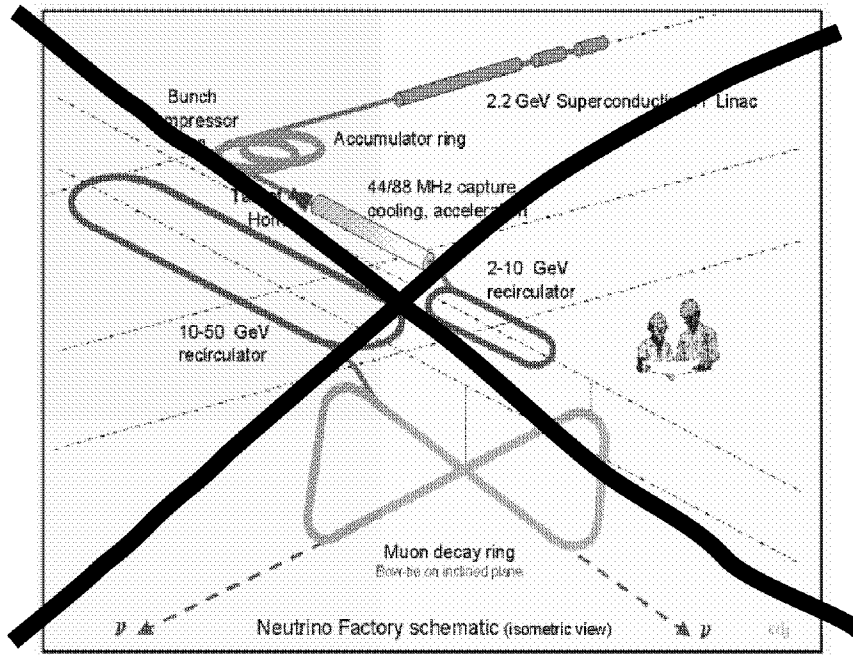

Alain Blondel 

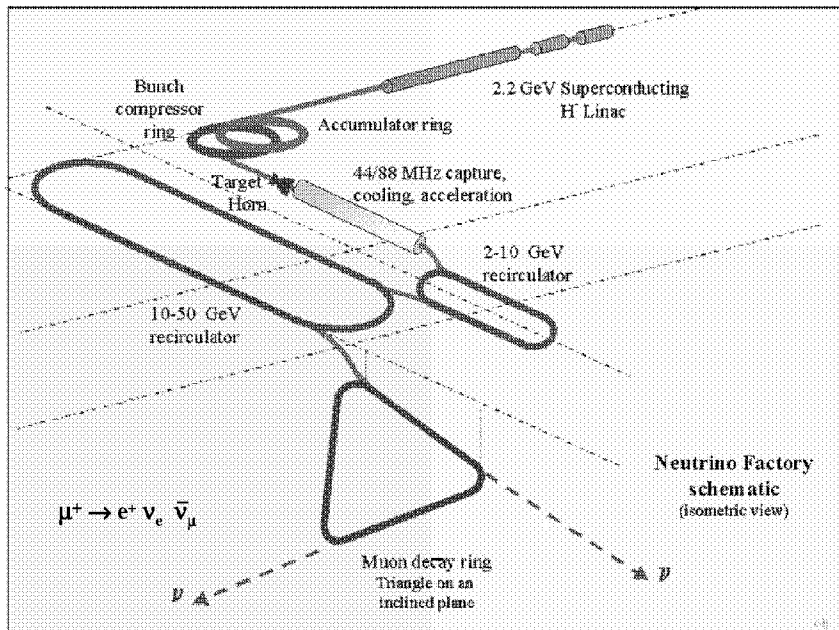

Alain Blondel 

## Angular divergence

If the muons have transverse momentum comparable to that of muon decay (50 MeV) the neutrino beam will be seriously degraded  
 this corresponds to  $\sigma(\theta) = 0.5 m_\mu / E_\mu \rightarrow$

in order for the effect of beam divergence to affect the flux by less than a few  $10^{-3}$  beam divergence must be very small.

I. Papadopoulos has calculated the effect.

Alain Blondel 

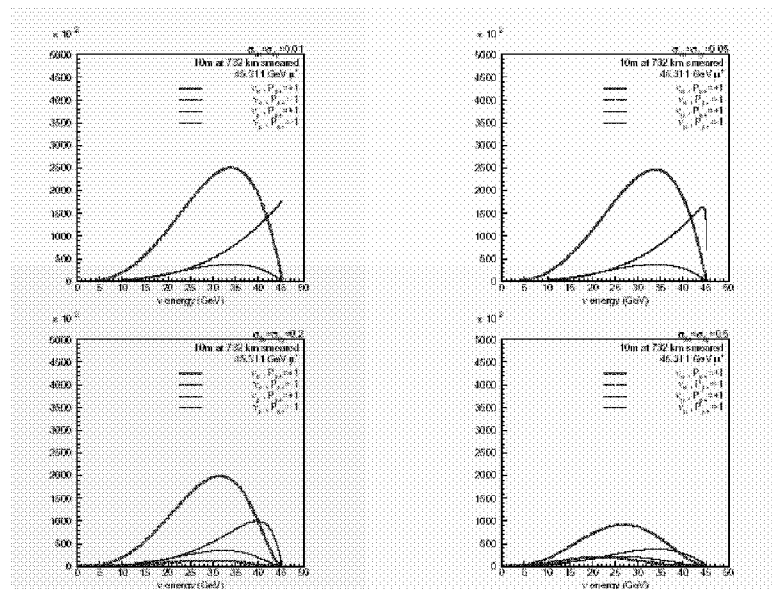

**Fig. 34:** Neutrino event spectra for different beam divergences: Upper left:  $\sigma_\theta = \sigma_\theta^0 = 0.01 m_\mu / E_\mu$ ; upper right:  $\sigma_\theta = \sigma_\theta^0 = 0.05 m_\mu / E_\mu$ ; lower left:  $\sigma_\theta = \sigma_\theta^0 = 0.2 m_\mu / E_\mu$ ; lower right:  $\sigma_\theta = \sigma_\theta^0 = 0.5 m_\mu / E_\mu$ . It is clear that beam divergence results in a loss of events, and in a sizeable distortion of the spectra and of their



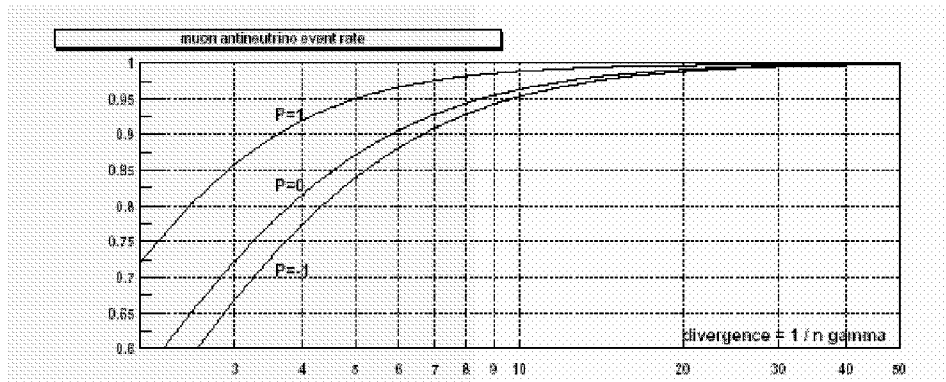

**divergence of  $0.1/\gamma$  keeps 95% of the original flux.**

**Straight section with this property were designed for the US Study II and by Keil**

Divergence **MUST** be measured.

A gas Cerenkov device to measure the beam emittance was devised by Piteira.

Various effects were considered (optical aberrations, heating of gas, multiple scattering, etc...and concluded that the divergence is easier to measure the bigger it is so that this should not be a problem)

Alain Blondel 

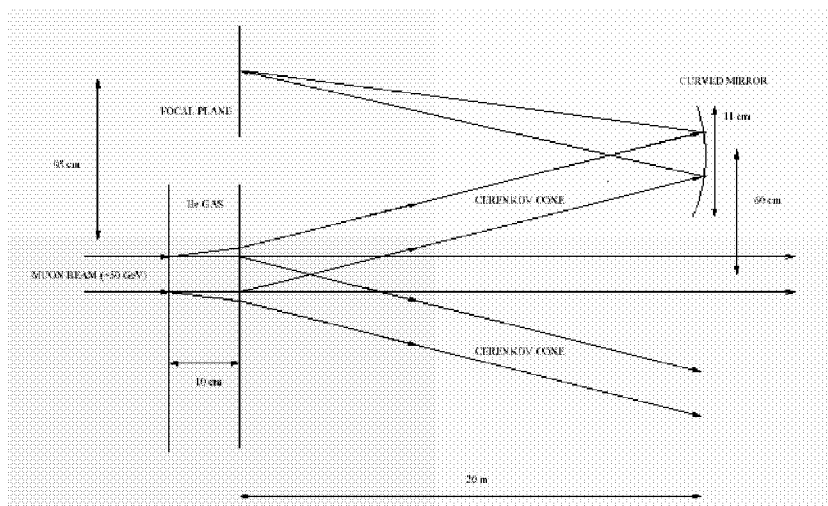

Schematic of a muon beam divergence measurement device. A low-pressure He gas volume is contained by windows (one of which must be transparent) within a straight section of the muon decay ring. The Cerenkov light is collected by a parallel to point optics in the direction of interest, so as to provide an image of the angular distribution of particles in the focal plane.

Alain Blondel 

## Radiative effects

Radiative effects  
by Broncano & Mena

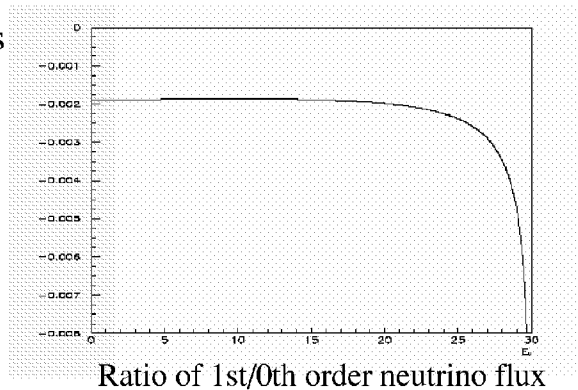

Dominated by the presence of a photon in the final state, which reduces the energy of the neutrino and thus the flux in forward direction.  
(the total number of neutrinos emitted is constant of course)

Effect is  $-0.4\%$  with a slight distortion of the end-point.  
Error is small fraction thereof.

Alain Blondel 

## Conclusions I

### Main parameters to MONITOR

1. Total number of muons circulating in the ring,  
BCT, near detector for purely leptonic processes
2. muon beam polarisation,  
polarimeter
3. muon beam energy and energy spread,  
race-track or triangle. NO BOW-TIE!  
+polarimeter
4. muon beam angle and angular divergence.  
straight section design  
+beam divergence monitors e.g. Cerenkov
5. Theory of  $\mu$  decay, including radiative effects  
OK

Yes, we believe that the neutrino flux can be monitored to  $10^{-3}$  IF

+ design of accelerator foresees sufficient diagnostics.

+ quite a lot of work to do to design and simulate these diagnostics

Alain Blondel 



## Conclusions II: and the Beta-beam?

### Main parameters to MONITOR

1. Total number of ions circulating in the ring,  
BCT, near detector for purely leptonic processes
2. ion beam polarisation, NO they are spin 0! → no problem
3. ion beam energy and energy spread,  
no polarization -- need magnetic field measurement.  
precision required a few  $10^{-4}$  (evt. rate goes like  $E^3$ )
4. ion beam angle and angular divergence.  
beam divergence monitor e.g. Cerenkov
5. Theory of ion decay, including radiative effects  
To be done

neutrino flux can probably be monitored to  $10^{-3}$

– somewhat more difficult than for muons, but not impossible.

provided:

+ design of accelerator foresees sufficient diagnostics.

+ quite a lot of work to do to design and simulate these diagnostics



## Where do you prefer to take shifts?

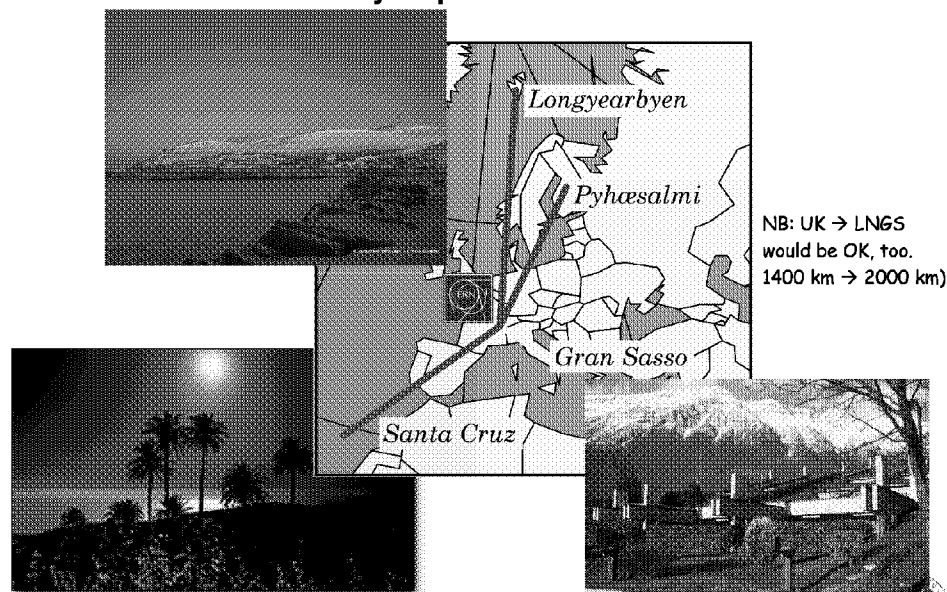

Alain Blondel



Combination of Beta beam and superbeam is in the same ballpark of performance as neutrino factory ...  
 (beware of systematics for low Energy neutrino events, though)

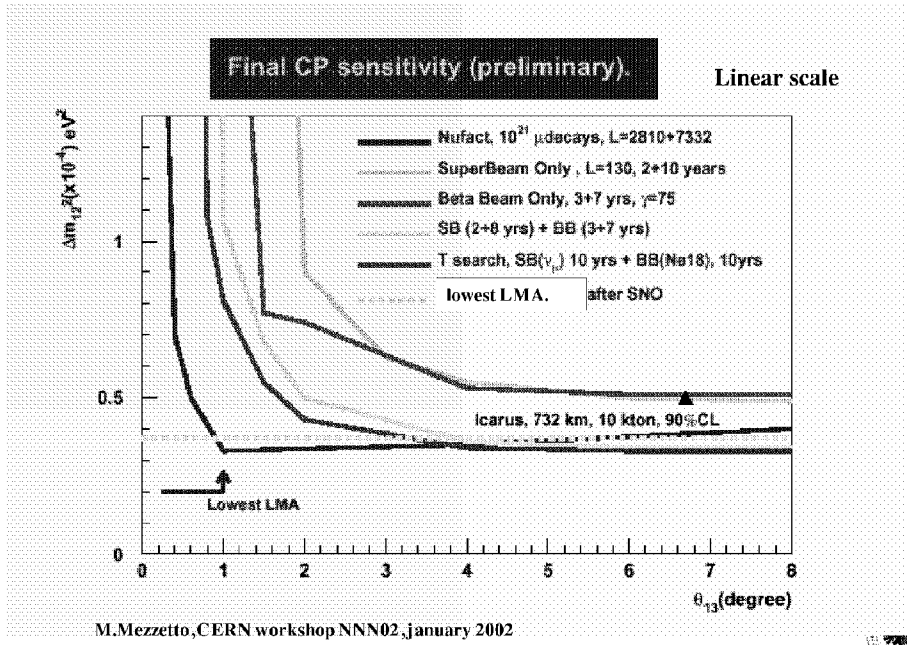

Alain Blondel



### Superbeam gets us quite a ways...

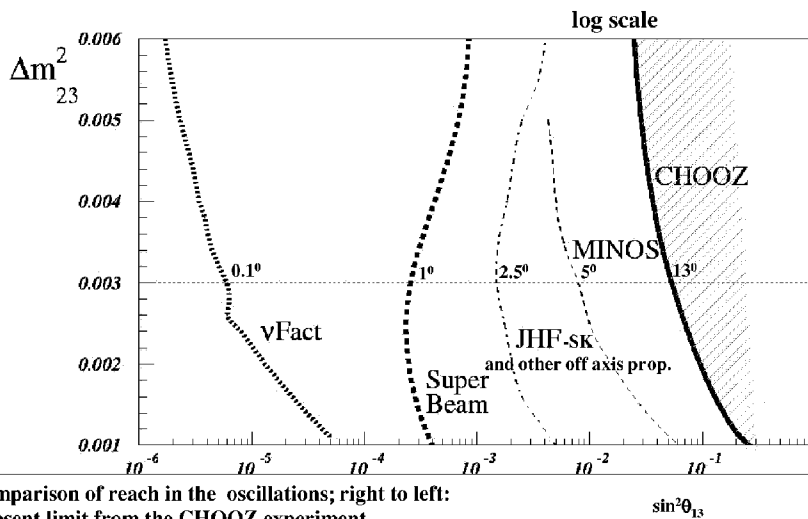

comparison of reach in the oscillations; right to left:  
 present limit from the CHOOZ experiment,  
 expected sensitivity from the MINOS experiment,  
 0.75 MW JHF to super Kamiokande with an off-axis narrow-band beam,  
 Superbeam: 4 MW CERN-SPL to a 400 kton water Cerenkov in Fréjus  
 from a Neutrino Factory with 40 kton large magnetic detector. INCLUDING SYSTEMATICS

## Last question: about financing?

⌘ For the time being our situation is not so good....

BUT.... Some ideas are developing...

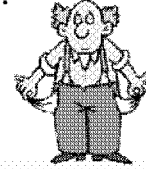

hep-ph/0111267  
TUM-HEP-483/01

### Could One Find Petroleum Using Neutrino Oscillations in Matter?

Tommy Ohlsson<sup>1,\*</sup> and Walter Winter<sup>1,†</sup>

<sup>1</sup>*Institut für Theoretische Physik, Physik-Department, Technische Universität München,  
Lanka-Frank-Str. 8, 85748 Garching bei München, Germany*

(Date: November 20, 2001)

It is now widely believed in neutrino physics that neutrino oscillations are influenced by the presence of matter, modifying the energy spectrum produced by a neutrino beam traversing the Earth. Here, we will discuss the reverse problem, i.e., what could be learned about the Earth's interior from a single neutrino baseline energy spectrum, especially about the Earth's mantle. In the end of the paper, we will finally investigate if one could really find petroleum using this method.

PACS numbers: 14.90.Lm, 13.15.+g, 91.35.-x

Alain Blondel



## Conclusions Conclusions

Neutrinos have mass and they mix.

This is a **NEW FORCE**, (beyond the SM)  
that could also generate proton decay  
the baryon asymmetry of the universe,  
 $\mu \rightarrow e \gamma$

....

A Neutrino Factory Complex (and in a first step a high intensity superbeam)  
would offer the possibility to discover leptonic CP violation  
and to measure the mass and mixing properties of neutrinos very precisely.  
Would offer a very versatile physics program on the side as well

We know that such a machines/detectors can be build and work.  
Cost would be too high today and techniques have never been tested in practice.

Requires R&D! Target/MICE Ascertain designs and find new ideas.  
Will follow also carefully beta-beam + super-beam combination  
Detector ideas are based on today's detectors MINOS, SUPERK, ICARUS, OPERA  
+ R&D for size

Following ECFA recommendations, a coordinated effort is being build in Europe  
(and across the world), goals and priorities set -- we will get there!



**we are living an exciting time**

Alain Blondel 

# LECTURE 3

## Towards a Neutrino Factory Complex

1. European R&D towards neutrino factory
  - proton accelerator
  - target
  - muon cooling experiment MICE
2. Other physics around a neutrino factory
  - stopped muons
  - high intensity neutrino scattering
3. Towards muon colliders
  - Higgs factory and CP violation



## -- Neutrino Factory -- CERN layout

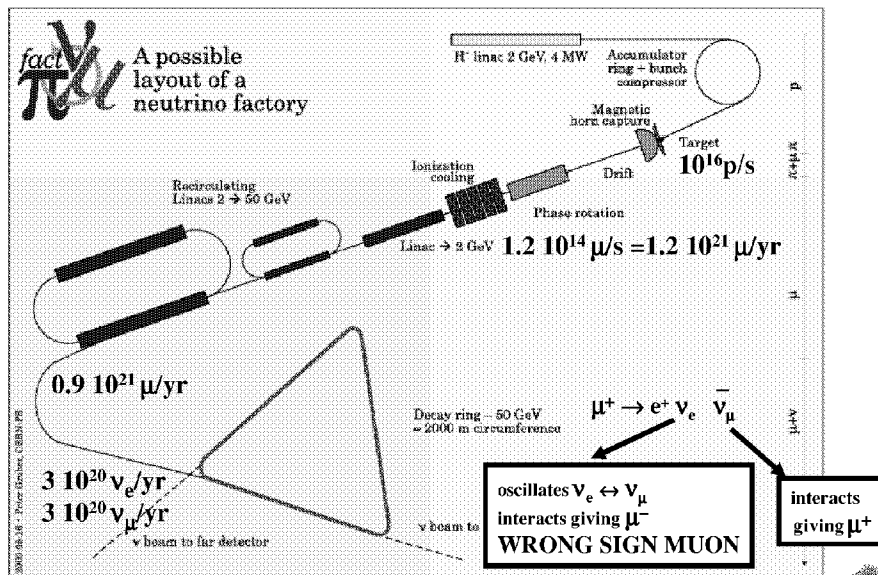

## Neutrino Factory studies and R&D

USA, Europe, Japan have each their scheme. Only one has been costed, US study II:

System	Sum (\$M)	Others <sup>a</sup> (\$M)	Total (\$M)	Reconciliation <sup>b</sup> (FY00 \$M)
Proton Driver	167.6	16.8	184.4	179.9
Target Systems	91.6	9.2	100.8	98.3
Decay Channel	4.6	0.5	5.1	5.0
Induction Linacs	319.1	31.9	351.0	342.4
Bunching	68.6	6.9	75.5	73.6
Cooling Channel	317.0	31.7	348.7	340.2
Pre-accel. linac	188.9	18.9	207.8	202.7
RLA	355.5	35.5	391.0	381.5
Storage Ring	107.4	10.7	118.1	115.2
Site Utilities	126.9	12.7	139.6	136.2
<b>Totals</b>	<b>1,747.2</b>	<b>174.8</b>	<b>1,922.0</b>	<b>1,875.0</b>

+ detector: MINOS \* 10 = about 300 M€ or M\$

Neutrino Factory CAN be done.....but it is too expensive as is.  
Aim: ascertain challenges can be met + cut cost in half.

Alain Blondel 

## EMCOG (European Muon Concertation and Oversight Group) FIRST SET OF BASIC GOALS

The long-term goal is to have a Conceptual Design Report for a European Neutrino Factory Complex by the time of JHF & LHC start-up, so that, by that date, this would be a valid option for the future of CERN.

An earlier construction for the proton driver (SPL + accumulator & compressor rings) is conceivable and, of course, highly desirable.

The SPL, targetry and horn R&D have therefore to be given the highest priority.

Cooling is on the critical path for the neutrino factory itself; there is a consensus that a cooling experiment is a necessity.

The emphasis should be the definition of practical experimental projects with a duration of 2-5 years. Such projects can be seen in the following four areas:

Alain Blondel 

1. **High intensity proton driver.** Activities on the front end are ongoing in many laboratories in Europe, in particular at CERN, CEA, IN2P3, INFN and GSI. Progressive installation of a high intensity injector and of a linear accelerator up to 120 MeV at CERN (R. Garoby et al) would have immediate rewards in the increase of intensity for the CERN fixed target program and for LHC operation. GSI.... EMCOG will invite a specific report on the status of the studies and a proposal for the implementation process.
2. **Target studies**
  - . This experimental program is already well underway with liquid metal jet studies. Goal: explore synergies among the following parties involved: CERN, Lausanne, Megapie at PSI, EURISOL, etc...
3. **Horn studies.**
  - A first horn prototype has been built and is being equipped for pulsing at low intensity. 5 year program to reach high intensity, high rep rate pulsing, and study the radiation resistance of horns. Optimisation of horn shape. Explore synergies between CERN, IN2P3 Orsay, PSI (for material research and fatigue under high stress in radiation environment)
4. **MICE.** A collaboration towards and International cooling experiment has been established with the muon collaboration in United States and Japanese groups. There is a large interest from European groups in this experiment. Following the submission of a letter of Intent to PSI and RAL, the collaboration has been encouraged to prepare a full proposal at RAL, with technical help from RAL. PSI offers a solenoid muon beam line and CERN, which as already made large initial contributions in the concept of the experiment, could earmark some very precious hardware that could be recuperated. A summary of the requests should be presented by the collaboration.

It is noted that the first three items are also essential for a possible initial neutrino program with a high intensity low energy conventional neutrino beam (superbeam).

Alain Blondel



## Proton Drivers

- **For CERN, two possibilities:**

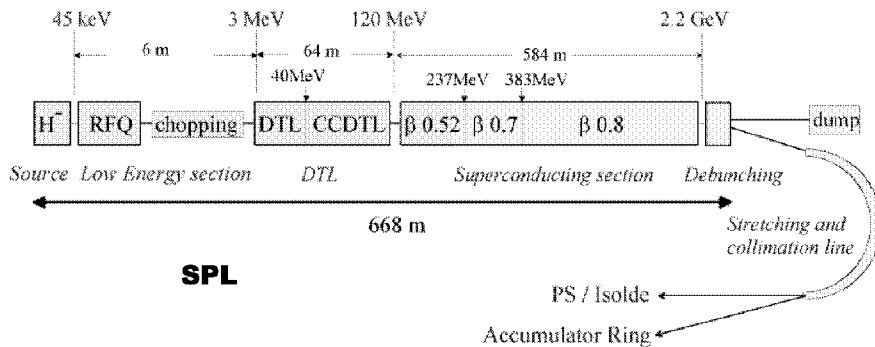

Uses LEP RF system

(capable of >20 MW ....)

a CW machine, needs accumulators

Alain Blondel



**SPL layout on the CERN site (top view)**

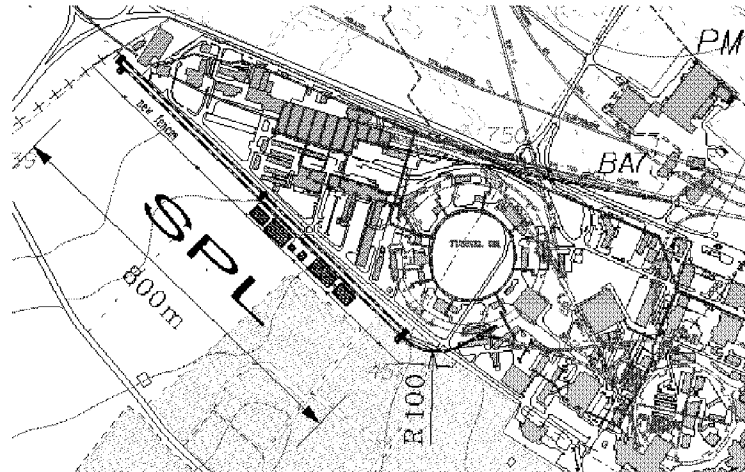

R. Garoby muon week 24-10-2000

Alain Blondel



A very potent machine indeed!

**SPL power consumption**

	NOMINAL (PULSED @ 75 Hz)	CONTINUOUS BEAM
Mean beam power	4 MW	24 MW
Electrical power consumption:		
- RF (mean RF power)	24MW (12 MW)	64 MW (32 MW)
- Cryogenics (cooling power at 4.5 K)	8 MW (32 kW)	20 MW (75 kW)
- Cooling & ventilation	2 MW	6 MW
- Other & general services	4 MW	5 MW
<b>Total electrical power consumption:</b>	<b>38 MW</b>	<b>95 MW</b>

Alain Blondel





## Proton Drivers

**30 GeV Rapid  
Cycling  
Synchrotron in  
the ISR tunnel**

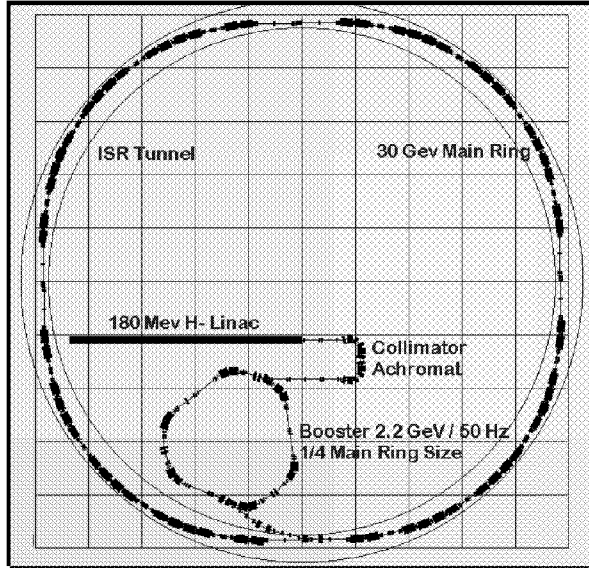

Alain Blondel

## Proton Drivers

### Cost comparison

	<i>PDAC</i>		<i>RCS</i>	
	MCHF		MCHF	
SPL	350	Linac	110	
Accumulator	63	Booster	88	
Compressor	50	Driver	233	
<b>TOTAL</b>	<b>463</b>	<b>TOTAL</b>	<b>431</b>	

*Schönauer*

**SPL: driver for a conventional superbeam to Frejus  
driver for  $\beta$ -beams  
R&D already started with CEA**

**RCS: replacement for PS**

Alain Blondel



## NUFACT R&D: Target station

### ⌘ Target:

☒ Dimension:  $L \approx 30 \text{ cm}$ ,  $R \approx 1 \text{ cm}$

→ 4 MW proton beam into an expensive cigar...

→ High Z → small size good for optics

→ Liquid → easy to replace ( $v_{jet} \approx 20 \text{ m/s}$ ) → Mercury



## Hg-jet p-converter target with a pion focusing horn

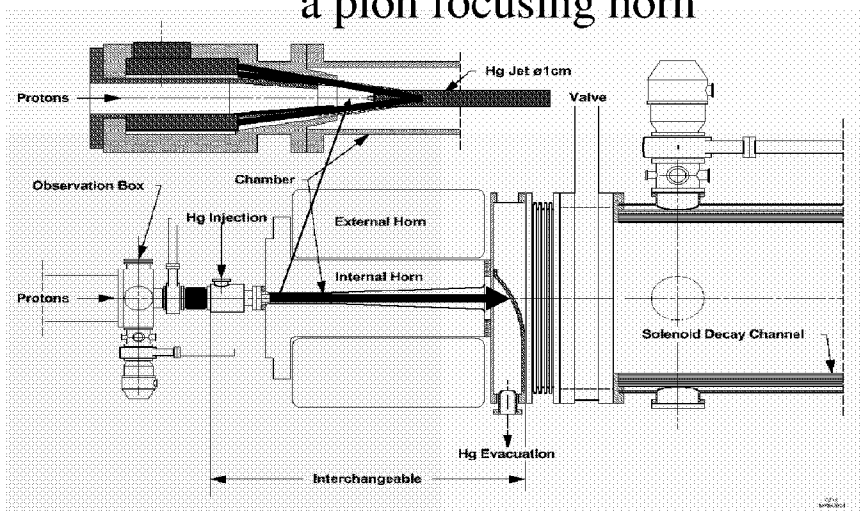

## NUFACT R&D: Target station

### Experiment @BNL and @CERN

- ⌘ Speed of Hg disruption
- ⌘ Max  $v_{\perp} \approx 20$  m/s measured
- ⌘  $v_{//} \approx 3$  m/s
- ⌘ jet remains intact for more than 20 microseconds.

E961 Mercury run  
4-25-2001

file #: jet-data-10-movie.gif  
grid size: 1 cm  
field of view: 13.2 cm x 13.2 cm  
frame rate: 1 ms  
exposure time: 150 ns  
proton energy: 24 GeV  
# of particles: 3.8 TP

1 cm  
Protons

Alain Blondel



US scheme:  
jet is inside a very high field tapered solenoid (20 T max)

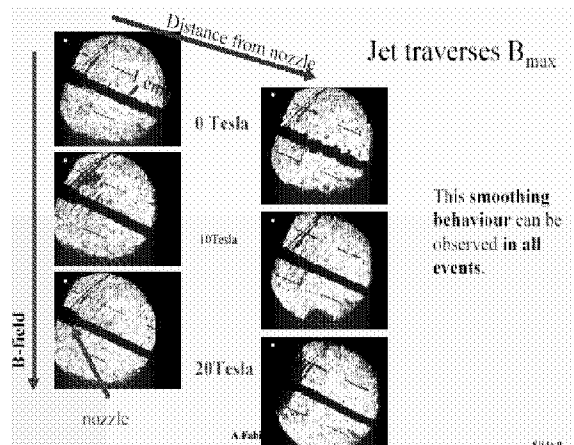
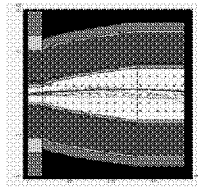

this was tested at the Laboratoire de Champs Intenses (Grenoble)

A. Fabich et al – CERN-BNL-Grenoble

Alain Blondel



## HORN STUDIES

horn is built at CERN  
 mechanical properties measured  
 (can it be pulsed at 350 kA and 50 Hz?  
 important for basic choice of proton driver)



This is the neutrino factory horn,  
 SPL-superbeam one will have different shape.



J.-M. Maugain,....(S.Gilardoni,UNIge) et al

Alain Blondel 

## NUFACT R&D; Cooling

⌘ Problem:  $\mu \rightarrow$  Beam pipe radius of storage ring

**$P_{\perp}$  or  $x'$  and  $x$  reduction needed: COOLING**

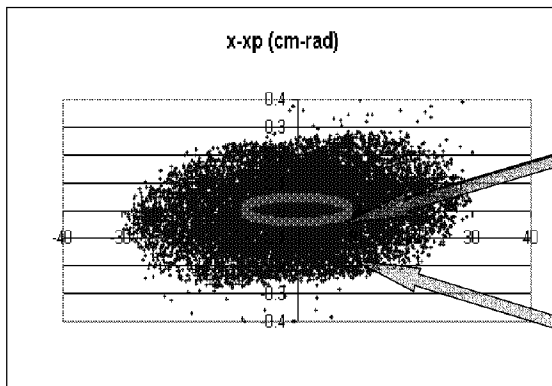

Accelerator acceptance  
 $R \approx 10$  cm,  $x' \approx 0.05$  rad  
 rescaled @ 200 MeV

$\pi$  and  $\mu$  after  
 focusing

Alain Blondel 

## Ionization Cooling : the principle

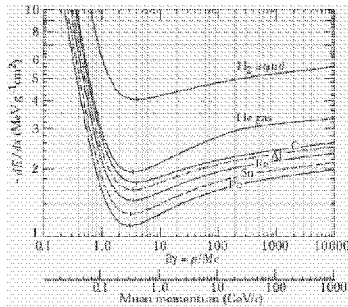
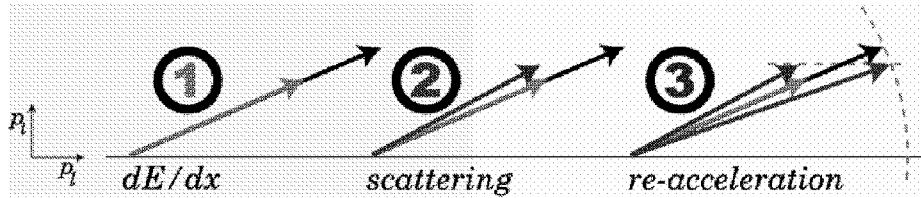

### Liquid H<sub>2</sub>: dE/dx

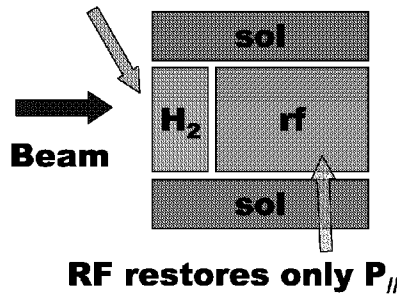

Alain Blondel



## What muon cooling buys

*MUON Yield without and with Cooling*

	<i>NOCOOL</i>	<i>with cooling</i>
<i>long. emittance</i>	0.05 eVs	0.05 eVs
<i>rotation</i>	$6.7 \times 10^{19}$	$6.7 \times 10^{19}$
<i>44 MHz</i>	$6.8 \times 10^{19}$	
<i>88 MHz</i>	$7.3 \times 10^{19}$	$1.2 \times 10^{21}$
<i>176 MHz</i>	$5.5 \times 10^{19}$	$1.0 \times 10^{21}$

exact gain depends on relative amount of phase rotation  
(monochromatization vs cooling trade off)

cooling of minimum ionizing muons has never been realized in practice  
involves RF cavities, Liquid Hydrogen absorbers, all in magnetic field  
designs similar in EU and US Nufact concepts

Alain Blondel



## IONIZATION COOLING

principle:

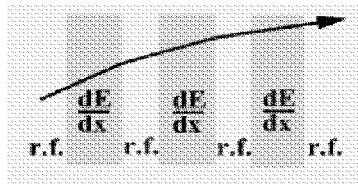

*this will surely work..!*

reality (simplified)

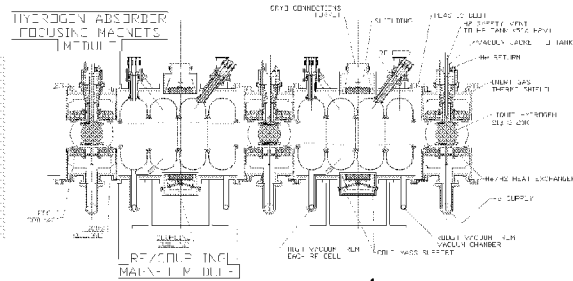

*...maybe...*

A delicate technology and integration problem

⇒ Need to build a realistic prototype and verify that it works (i.e. cools a beam)

**Difficulty:** affordable prototype of cooling section only cools beam by 10%, while standard emittance measurements barely achieve this precision.

**Solution:** measure the beam particle-by-particle

*state-of-the-art particle physics instrumentation will test state-of-the-art accelerator technology.*

⇒ RF Noise??



Alain Blondel

## An International Muon Ionization Cooling Experiment

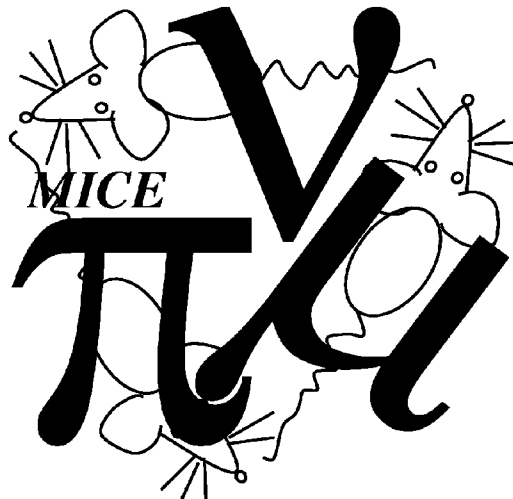

Alain Blondel





10% cooling of 200 MeV/c muons requires ~ 20 MV of RF  
 single particle measurements =>  
 measurement precision can be as good as  $\Delta(\epsilon_{out}/\epsilon_{in}) = 10^{-3}$   
 never done before either....

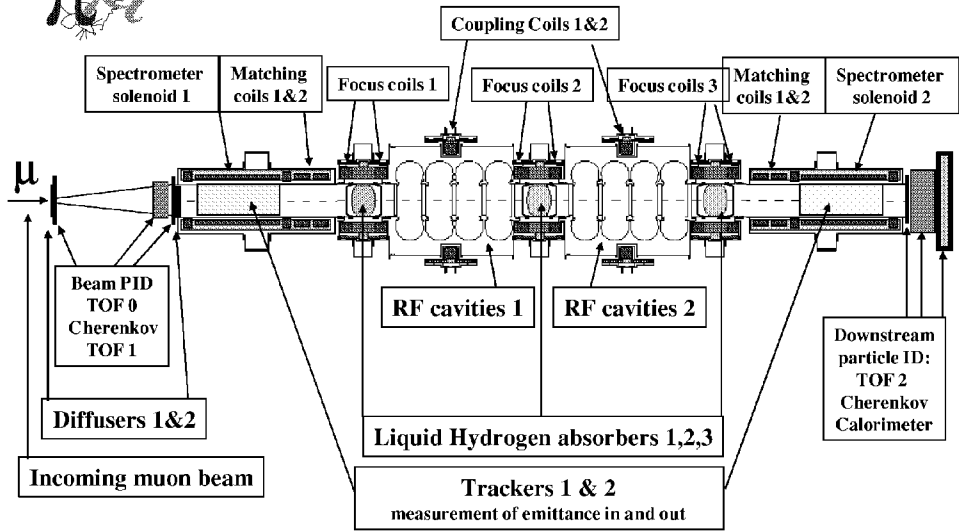

Quantities to be measured in a cooling experiment

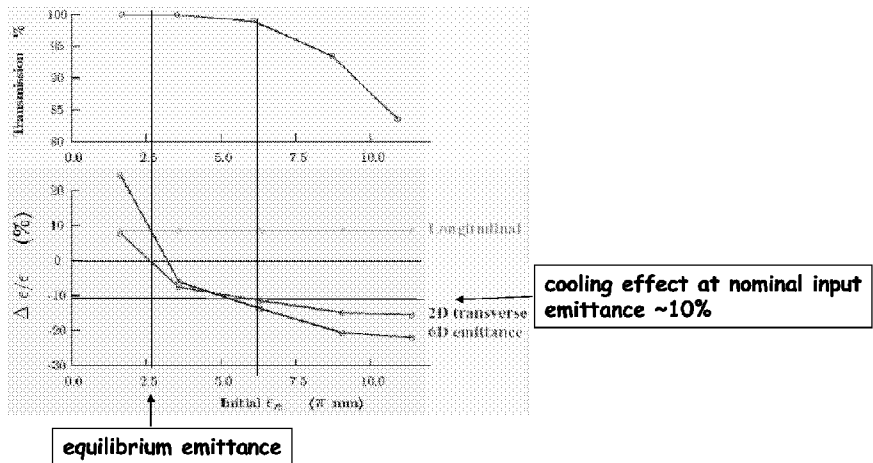

curves for 23 MV, 3 full absorbers, particles on crest

## Emittance measurement

Each spectrometer measures 6 parameters per particle

$$\begin{matrix} x & y & t \\ x' = dx/dz = p_x/p_z & y' = dy/dz = p_y/p_z & t' = dt/dz = E/p_z \end{matrix}$$

Determines, for an ensemble (sample) of N particles, the moments:

Averages  $\langle x \rangle$   $\langle y \rangle$  etc...

Second moments: variance(x)  $\sigma_x^2 = \langle x^2 - \langle x \rangle^2 \rangle$  etc...  
 covariance(x)  $\sigma_{xy} = \langle x \cdot y - \langle x \rangle \langle y \rangle \rangle$

Covariance matrix

$$M = \begin{pmatrix} \sigma_x^2 & \sigma_{xy} & \sigma_{xt} & \sigma_{xt} & \sigma_{yt} & \sigma_{xt} \\ \dots & \sigma_y^2 & \dots & \dots & \dots & \sigma_{yt} \\ \dots & \dots & \sigma_t^2 & \dots & \dots & \sigma_{tt} \\ \dots & \dots & \dots & \sigma_x^2 & \dots & \sigma_{xt} \\ \dots & \dots & \dots & \dots & \sigma_y^2 & \sigma_{yt} \\ \dots & \dots & \dots & \dots & \dots & \sigma_t^2 \end{pmatrix}$$

Getting at e.g.  $\sigma_{xt}$  is essentially impossible with multiparticle bunch measurements

Evaluate emittance with:  $\epsilon^{6D} = \sqrt{\det(M_{xytx'yt'})}$   
 $\epsilon^{4D} = \sqrt{\det(M_{xyx'y'})} = \epsilon_{\perp}^2$

Compare  $\epsilon^{in}$  with  $\epsilon^{out}$



Alain Blondel

requirements on spectrometer system:

1. must be sure particles considered are muons throughout
  - 1.a reject incoming e, p,  $\pi$   
=> TOF 2 stations 10 m flight with 70 ps resolution
  - 1.b reject outgoing e => Cerenkov + Calorimeter
2. measure 6 particle parameters  
i.e. x, y, t,  $p_x/p_z$ ,  $p_y/p_z$ ,  $E/p_z$
3. measure widths and correlations ...  
resolution in all parameters must be better than 10% of width at equilibrium emittance (correction less than 1%)  
 $\sigma_{meas}^2 = \sigma_{true}^2 + \sigma_{res}^2 = \sigma_{true}^2 [ 1 + (\sigma_{res}/\sigma_{true})^2 ]$
4. robust against noise from RF cavities



Alain Blondel



tracking in a solenoid:

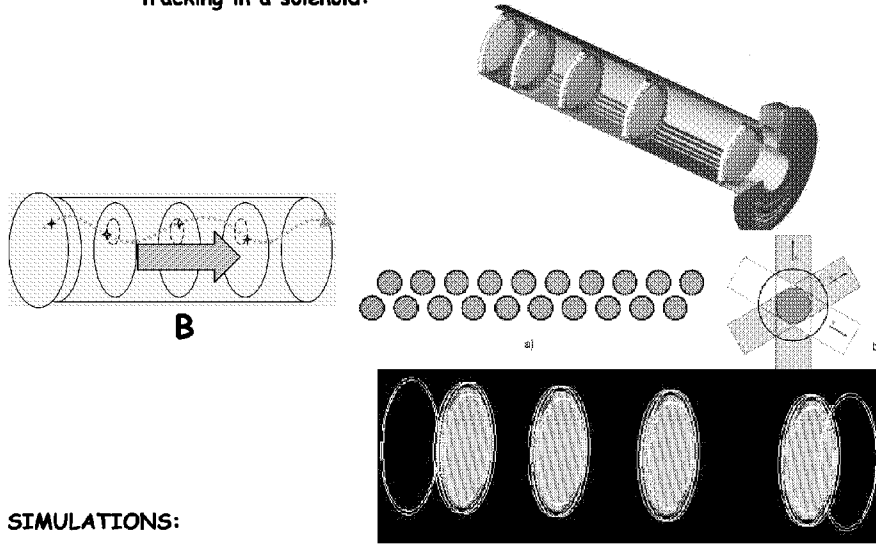

**SIMULATIONS:**

LOI: DWARF4.0 by P.Janot: a fast simulation including  $dE/dx$  & MS (ad-hoc)

Proposal: G4MICE: Geant 4 application including everything including noise  
(long term FOUNDATION FOR MICE software)

Alain Blondel



**RESULTS**

TRANSVERSE MOMENTUM RESOLUTION  $\sigma_{pt} = 110 \text{ keV}$

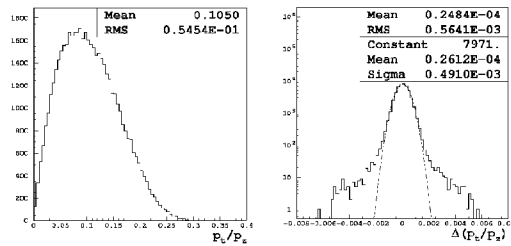

$P_z$  resolution degrades at low  $p_t$  :

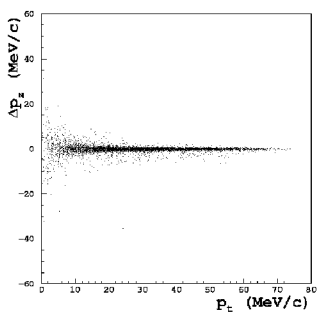

resolution in  $E/P_z$  is much better behaved

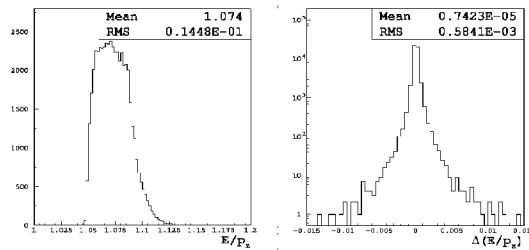

measurement rms is 4% of beam rms

Alain Blondel



# Backgrounds

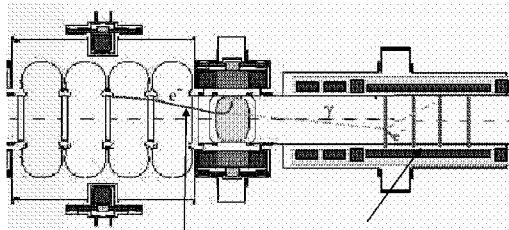
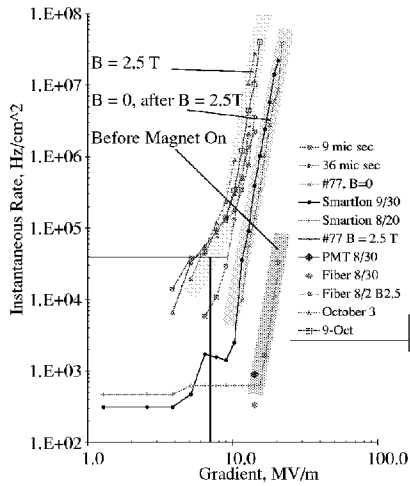

real background  
reduced by factor  
 $L/X0(H2) \cdot L/X0(det)$   
0.07      0.0026

Dark current backgrounds measured on a 805 MHz cavity in magnetic field with a 1mm scintillating fiber at  $d=O(1m)$

Extrapolation to MICE (201 MHz):  
scale rates as (area.energy) X 100  
and apply above reduction factor  $2 \cdot 10^{-4}$   
  
 $4 \cdot 10^4 \text{ Hz/cm}^2 @ 8 \text{ MV/m} @ 805 \text{ MHz}$   
 $\Rightarrow 0.8 \text{ kHz/cm}^2 \text{ per sci-fi}$   
 $\Rightarrow 500 \text{ kHz/plane}$   
 ! within  $\pm$  one order of magnitude !

Alain Blondel

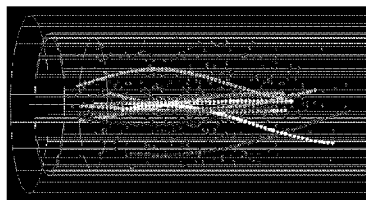
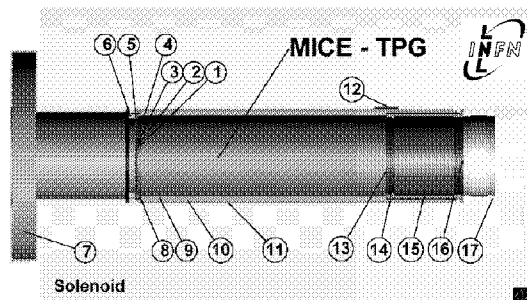

at noise rate similar to that simulated for fibers, no difficulty finding tracks and measuring them.

resolution somewhat better than sci-fi (which is good enough)

difficulty: nobody knows the effect of RF photons on the GEM themselves tests in 2003, decision October 2003

Alain Blondel



## International Muon Ionization Cooling Experiment

### Steering committee:

A. Blondel\* (University of Geneva) H. Haseroth (CERN\*\*) R. Edgecock (Rutherford Appleton Laboratory)  
Y. Kuno (Osaka University)  
S. Geer (FNAL) D. Kaplan (Illinois Institute of Technology) M. Zisman (Lawrence Berkeley Laboratory)  
\* convener for one year (June 2001-2002)

### Conveners of Technical teams:

a) **Concept development and simulations:** Alessandra Lombardi (CERN \*\*) Panagiotis Spentzouris (FNAL)  
Robert B Palmer (BNL)  
b) **Hydrogen absorbers:** Shigeru Ishimoto (KEK) Mary-Anne Cummings (Northern Illinois)  
c) **RF cavities and power sources** Bob Rimmer (LBNL) Roland Garoby (CERN\*\*)  
d) **Magnets** Mike Green (LBNL) Jean-Michel Rey (CEA Saclay)  
e) **Particle detectors** Vittorio Palladino (INFN Napoli) Alan Bross (FNAL)  
f) **Beam lines** Rob Edgecock (RAL) Claude Petitjean (PSI)  
g) **RF radiation** Jim Norem (Argonne) Ed McKigney (IC London)

### Participating institutes

INFN Bari INFN Milano INFN Padova INFN Napoli INFN LNF Frascati Roma  
INFN Trieste INFN Legnaro INFN Roma I Roma II Roma III  
Rutherford Appleton Laboratory University of Oxford Imperial College London  
DAPNIA, CEA Saclay  
Louvain La Neuve  
NESTOR institute University of Athens Hellenic Open University  
CERN\*\* (H. Haseroth)

\*\* only some limited simulation work and lend of used or refurbished equipment

University of Geneva University of Zurich ETH Zurich PSI  
KEK Osaka University  
Argonne National Laboratory Brookhaven National Laboratory Fermi National Accelerator Laboratory  
Lawrence Berkeley National Laboratory University of California Los Angeles University of Mississippi  
University of Indiana/ U.C. Riverside, Princeton University  
University of Illinois University of Chicago – Enrico Fermi Institute  
Michigan State University Northern Illinois University  
Illinois Institute of Technology

Alain Blondel



## Other physics opportunities at a V-factory complex

### Related to high intensity

Could begin as soon as SPL/accumulator is build:

- High intensity low energy muon experiments
  - rare muon decays and muon conversion (lepton Flavor violation)
  - $G_F$ ,  $g-2$ , edm, muonic atoms,  $e^+ \mu^- \leftrightarrow e^- \mu^+$
  - > design of target stations and beamlines needed.
- 2d generation ISOLDE (Radioactive nuclei)
  - extend understanding of nuclei outside valley of stability
  - muonic atoms with rare nuclei(?)

if a sufficient fraction of the protons can be accelerated to  $E > 15$  GeV:

- High intensity hadron experiments
  - rare K decays (e.g.  $K \rightarrow \pi^0 \nu \nu$ )

In parallel to long baseline neutrino experiments:

- short baseline neutrino experiments (standard fluxes  $\times 10^4$ )
  - DIS on various materials and targets, charm production
  - NC/CC  $\rightarrow m_W$  (10-20 MeV)  $\nu_\mu e \rightarrow \nu_\mu e$  &  $\nu_e e \rightarrow \nu_e e \rightarrow \sin^2 \theta_w^{\text{eff}}$  ( $2.10^{-4}$ )
  - > design of beamline + detectors needed

Alain Blondel



Rare muon decays

Lepton flavor violating processes  $\mu \rightarrow e\gamma$ ,  $\mu \rightarrow eee$ ,  $\mu^- N \rightarrow e^- N$   
observation of any of these decays would be  
**A MAJOR DISCOVERY**

From mixed neutrino loops: completely negligible rates ( $10^{-50}$ )

Rate in vicinity of observability due to SUSY loops

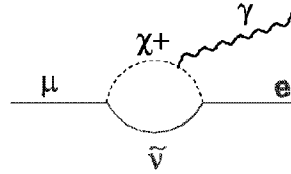
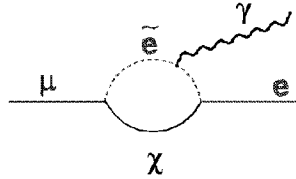

Or new (e.g RPV) interactions  
-- four-fermion operators

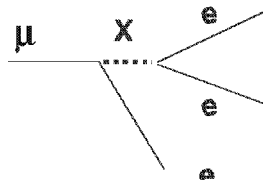

Alain Blondel

Rates for  $\mu \rightarrow e\gamma$

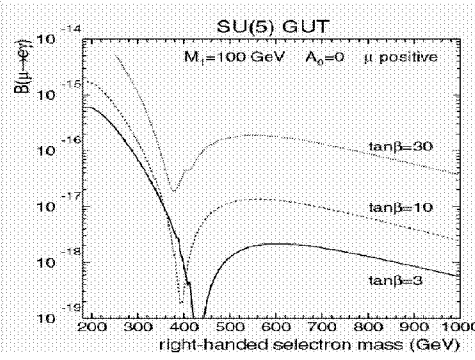
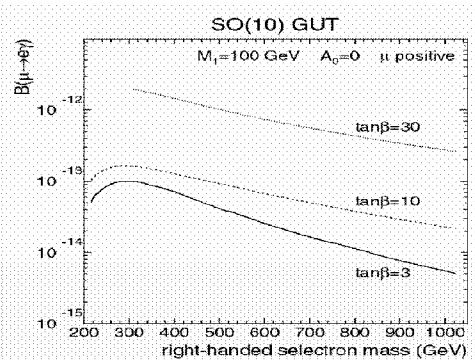
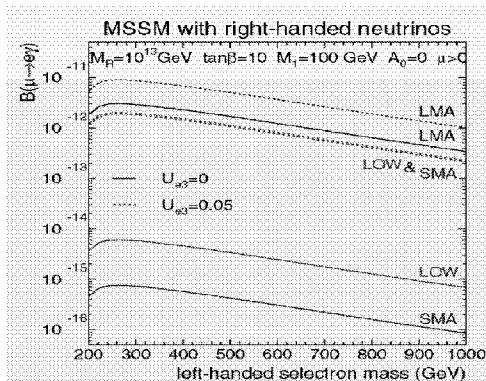

Message: it is difficult in SUSY to avoid  $\mu \rightarrow e\gamma$   
at a rate visible in the next generations of expts.  
(PSI MEG should go to a few  $10^{-14}$ )

**Present lines of thought for High Intensity Low Energy muon beams**

PSI already has 1 MW DC beam of 590 MeV protons  
with 5%  $\lambda_T$  target for muons. How can one do 1000 times better?

DC beams ( $\mu \rightarrow e\gamma$ ,  $\mu \rightarrow eee$ )

1. Thin inner target in proton accumulator
  - advantages: very efficient use of proton beam, point source
  - difficulties: - can target take the heat?
  - creates high-radiation area inside ring 20 - 120

2. Or Use full DC SPL 24 MW with thin muon target 20

- + solenoid collection  $(1/.16)^2 = 40$
- + better experiments ?

Pulsed beam ( $\mu^- N \rightarrow e^- N$ )

1. Use proton beam from buncher
2. Use muons at the end of cooling channel!

--> need now conceptual design of target station and muon beams

Alain Blondel

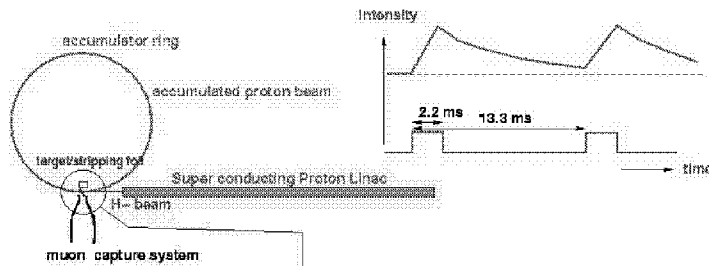

**A DC beam from SPL?**

Issue # 1:

will thin rotating target take the heat?

under study.

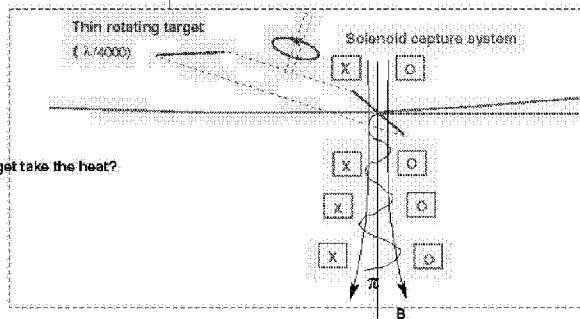

Alain Blondel



## Thoughts for muon targets in neutrino factory complex

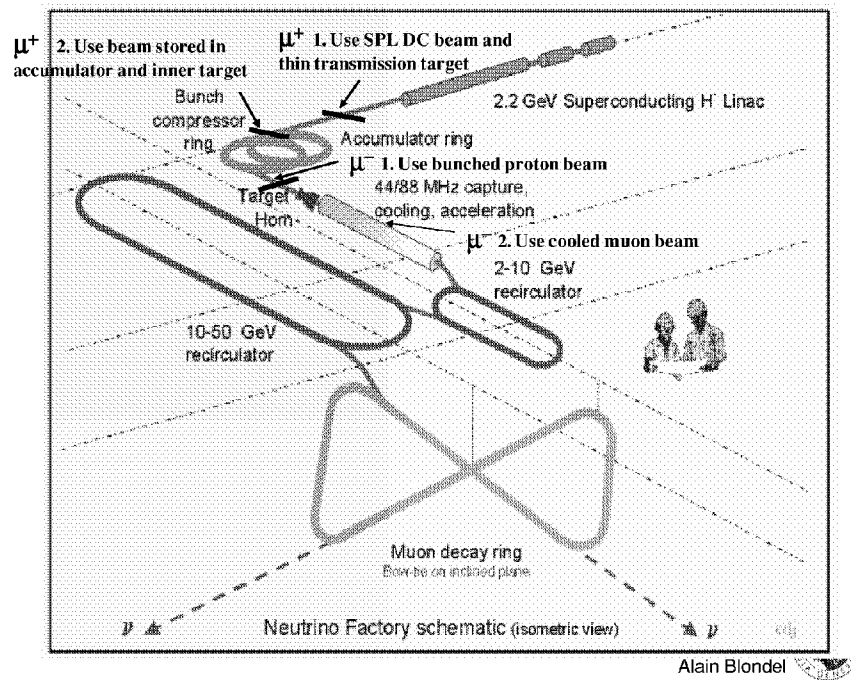

## Neutrino scattering experiments

Event rates very high.

High energy + small ring preferred

M. Mangano et al have evaluated in realistic way performance of possible experiments.

=> detector must measure scattered  $\mu$  as well as e

Big gains of precision in

- DIS structure functions
- nuclear effects,
- Higher twist effects
- QCD fits
- Polarised structure functions  
(neutrinos ARE polarised! Polarised targets)

ELECTROWEAK STUDIES

- NC/CC (efficient electron ID crucial here!)
- $\nu_\mu e \rightarrow \nu_\mu e$  &  $\nu_e e \rightarrow \nu_e e \rightarrow \sin^2\theta_w^{\text{eff}} (\pm 2.10^{-4})$

Alain Blondel



### Neutrino fluxes at near-by detectors

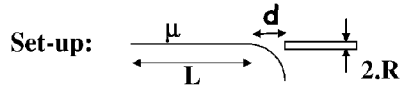
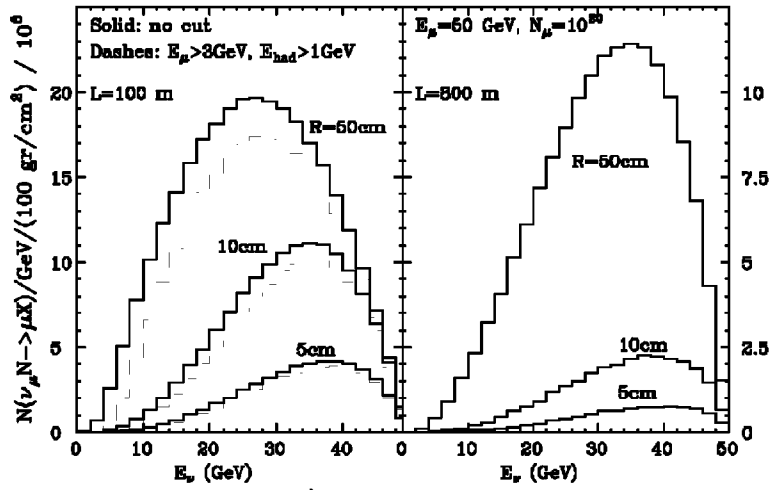

Integrated event rates  $2.10^8/\text{kg}/\text{year}$   
prefer small ring, short straight-sections

Alain Blondel



### Sort out nucleon spin structure

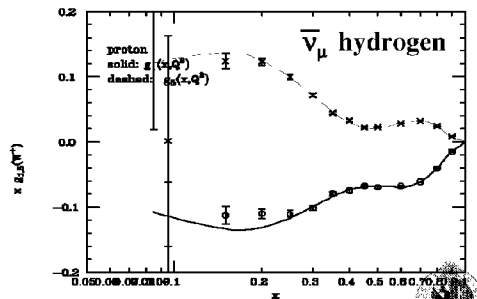
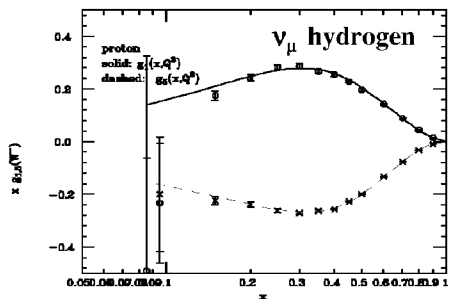
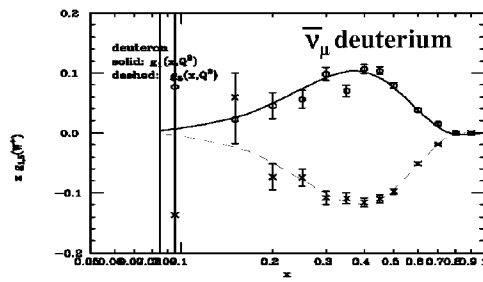
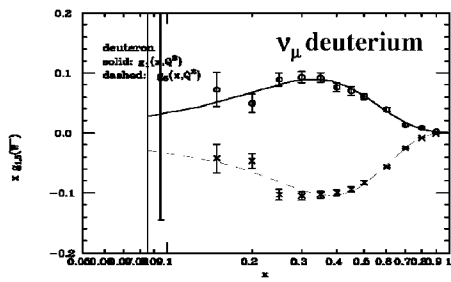

Alain Blondel



## Precision physics with neutrinos

$\Rightarrow \nu_\mu e \rightarrow \nu_\mu e$  &  $\nu_e e \rightarrow \nu_e e$

$10^7$  events/year in  $L=20\text{m}$   $R=20\text{ cm}$   
liq. scintillator detector  
 $\mu^+$  beam much better.  $\rightarrow$

flux normalization crucial.

$\Delta\Phi/\Phi = 10^{-3}$  allows  $\Delta\sin^2\theta_w^{\text{eff}} = \pm 2 \cdot 10^{-4}$

Noted:  $\nu_\mu e \rightarrow \mu^- \nu_e$  provides  
absolute normalization of  $\mu^-$  beam w  $10^8$  evts/yr  
(carry over to  $\mu^+$  beam?)

$\Rightarrow \nu N$  (NC/CC  $\rightarrow m_W$ ) under study

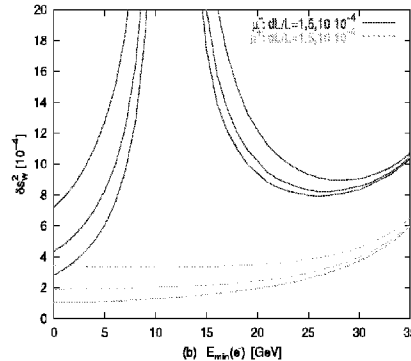

Accept e above  $E_{\text{min}}$

Alain Blondel 

## Beyond V-factory

### Step 1 towards muon collider(s)

#### Higgs and top factories

benefit from Higgs couplings ( $\sigma_{\text{higgs}} \propto m^2$ )  
and superior energy calibration/resolution  
ideal for  $m_h = 115 \text{ GeV}/c^2$ !  
and for study of Susy Higgses  $H, A$   
(masses, widths, couplings and CP violation)  
 $\rightarrow$  experimental feasibility needed (backgrounds, efficiencies, etc.)

Energy frontier (synergy with CLIC studies)

Alain Blondel 



### why muons?

muon collider is not a new idea (Skrinsky 1971)  
but it involves considerable difficulties.  
Why would one want to do this?

Muons characteristics:	With respect to e <sup>+</sup> e <sup>-</sup> colliders
<b>A. Muons are leptons</b>	
• Collisions to the full energy:	=
• Low and well-known physics backgrounds.	=
<b>B. Muons are heavy</b>	
• No synchrotron radiation:	
Small collider rings:	+
• No beamstrahlung:	
Energy resolution can be excellent:	+++
• Large coupling to Higgs bosons:	
$\mu^+\mu^- \rightarrow h, A, H$ cross section sizeable.	+++
<b>C. Muons are polarized (<math>\pi^+</math> decays) and they decay</b>	
• Infinitely precise energy calibration:	
Precise study of resonances (and of thresholds).	+++

Alain Blondel 

### From neutrino factory to Higgs collider

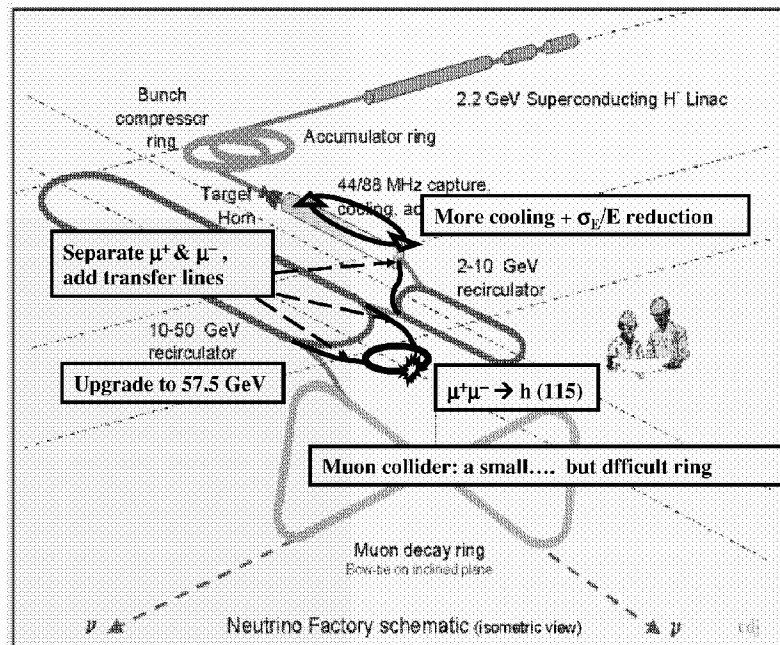

Alain Blondel 

### challenges of $\mu\mu$ collider

Now needs not only muons but also a very small beam.

- From neutrino factory to muon collider
- keep both signs of muons
- much more transverse cooling
- much better reduction of energy spread
- ring cooler?
- trade off between energy spread and transverse beam size:

$$N_{\text{events}} = \mathcal{L} \cdot \sigma \quad \mathcal{L} = \frac{f N_1 N_2}{4\pi\sigma_x \sigma_y}$$

$f$  = repetition rate (frequency of crossings)  
 $N_1$  particles in each bunch of beam 1  
 $N_2$  particles in each bunch of beam 2  
 $\pi\sigma_x \sigma_y$  : area of beam ellipse.

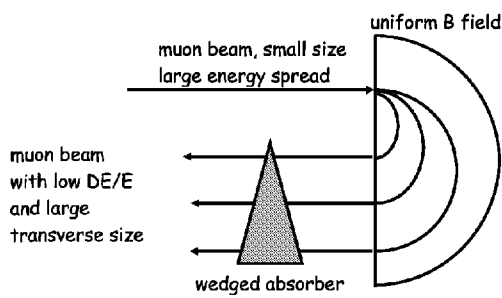

With a 4 MW proton driver; repetition rate 15 Hz:

$\delta E/E$ (%)	0.12	0.01	0.003
$\sigma_{x,y}$ ( $\mu\text{m}$ )	86	196	294
$\mathcal{L}$ ( $\text{cm}^{-2}\text{s}^{-1}$ )	$1.2 \cdot 10^{32}$	$2.2 \cdot 10^{31}$	$1.0 \cdot 10^{31}$
$\int \mathcal{L} dt/\text{year}$	$1.2 \text{ fb}^{-1}$	$220 \text{ pb}^{-1}$	$100 \text{ pb}^{-1}$

With 20 MW → 2.5 fb<sup>-1</sup> ?

Alain Blondel

## COOLING RINGS

- Two goals: 1) Reduce hardware expense on cooling channel  
 2) Combine with energy spread reduction (longitudinal and transverse cooling)

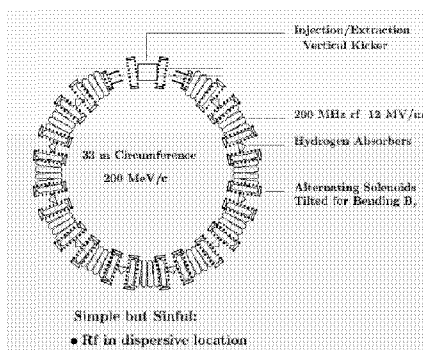

major problem: Kickers

(Same problem occurs in Japanese acceleration scheme with FFAG)

### ICOOL Simulation

Input From Study 2  
 $n/n = 485 / 1000$

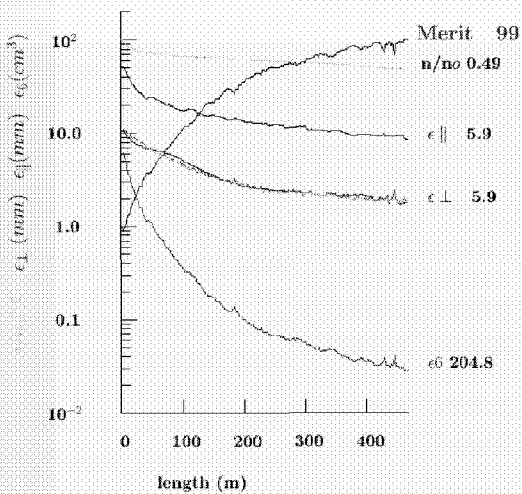

### Higgs factory $\mu^+ \mu^- \rightarrow h(115)$

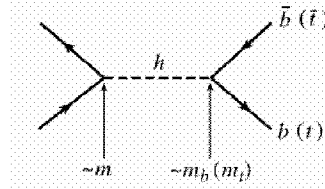

- S-channel production of Higgs is unique feature of Muon collider
- no beamstrahlung or Synch. Rad., g-2 precession
- => outstanding energy calibration (OK) and resolution  $R=DE/E$  (needs ideas and R&D, however!)

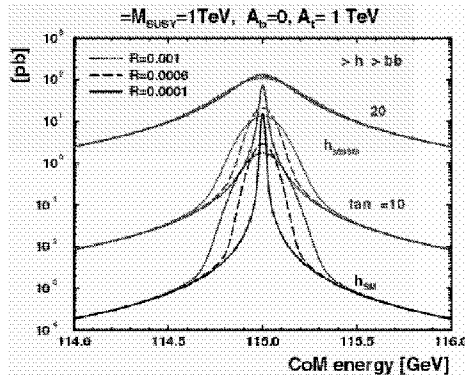

$\Delta m_h = 0.1 \text{ MeV}$   
 $\Delta \Gamma_h = 0.3 \text{ MeV}$   
 $\Delta \sigma_{h \rightarrow bb} / \sigma_h = 1\%$

very stringent constraints on Higgs couplings ( $\mu, \tau, b$ )



Alain Blondel

### The Higgs Line Shape

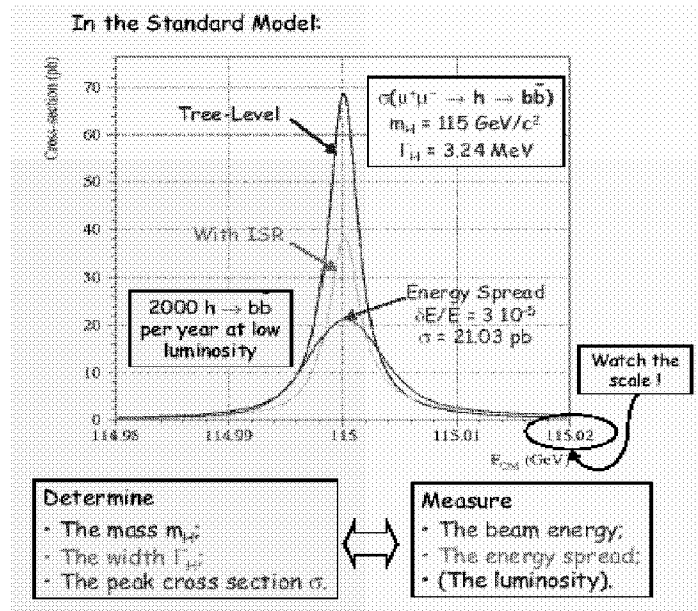

Alain Blondel

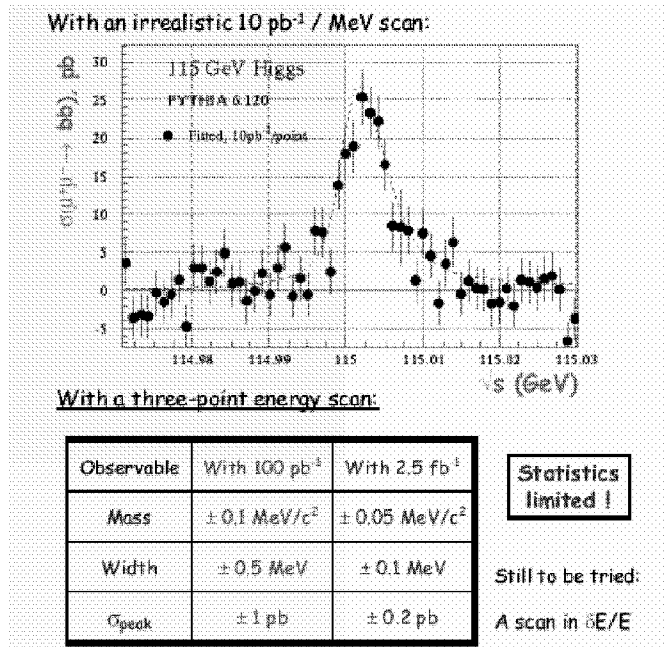

Alain Blondel

### Higgs Factory #2: $\mu^+ \mu^- \rightarrow H, A$

SUSY and 2DHM predict two neutral heavy Higgs with masses close to each other and to the charged Higgs, with different CP number, and decay modes.

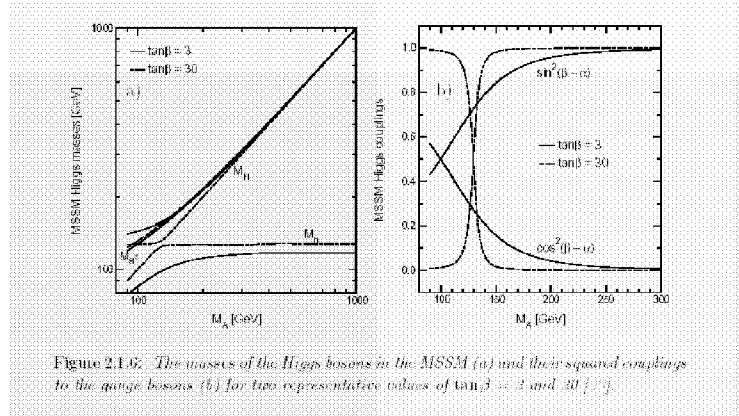

Alain Blondel

## Higgs Factory #2: $\mu^+ \mu^- \rightarrow H, A$

SUSY and 2DHM predict two neutral heavy Higgs with masses close to each other and to the charged Higgs, with different CP number, and decay modes.

Cross-sections are large. Determine masses & widths to high precision.

Telling H from A:  
bb and tt cross-sections  
(also: hh, WW, ZZ,.....)

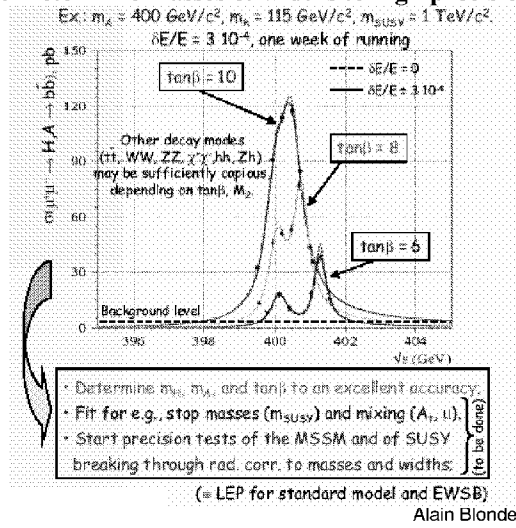

## CP violation in Higgs sector

$$\begin{pmatrix} \Phi_1 \\ \Phi_2 \\ a \end{pmatrix} = M \begin{pmatrix} H_1 \\ H_2 \\ H_3 \end{pmatrix} = (\text{if CP conserved}) \begin{pmatrix} h \\ A \\ H \end{pmatrix}$$

Effects are very small in SM, MSSM (loops), but could be larger in general

M= 3X3 matrix of Higgses with different CP numbers

Light Higgs:  
polarization asymmetries

Heavy Higgs: any mixing/interference between H and A => CP violation  
Interference or "wrong decays"-> CP violation look for A->hh, for instance.

Alain Blondel

- SUSY parameters (e.g.,  $A_t$  and  $\mu$ ) may have phases, which lead to CP violation in the Higgs sector and H/A mixing.
- Muon polarization (even partial) allows to measure CP sensitive cross sections:  $\sigma_{LL}$ ,  $\sigma_{RR}$ ,  $\sigma_{LR}$ ,  $\sigma_{RL}$ ,  $\sigma_{\parallel}$ ,  $\sigma_{\perp}$ .
- Nonzero values for  $\sigma_{RR} - \sigma_{LL}$  or  $\sigma_{\perp}$  come from nonzero phases of the MSSM parameters.

e.g., for  $\tan\beta = 3$ ,  $|A_t| = |\mu| = 1$  TeV,  $m_{H_t} = 400$  GeV:

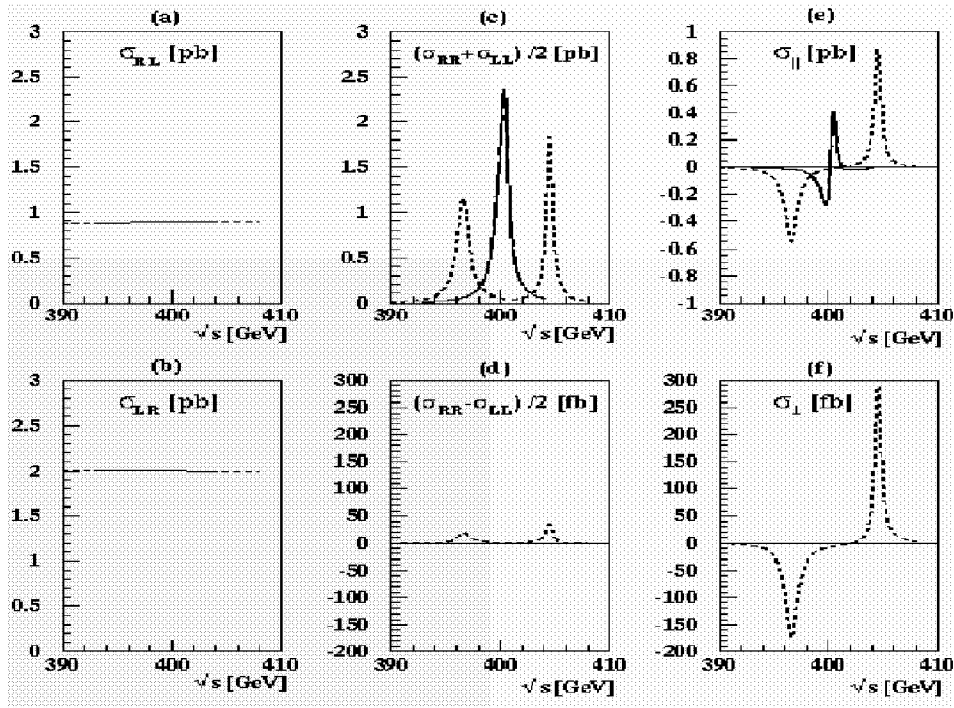
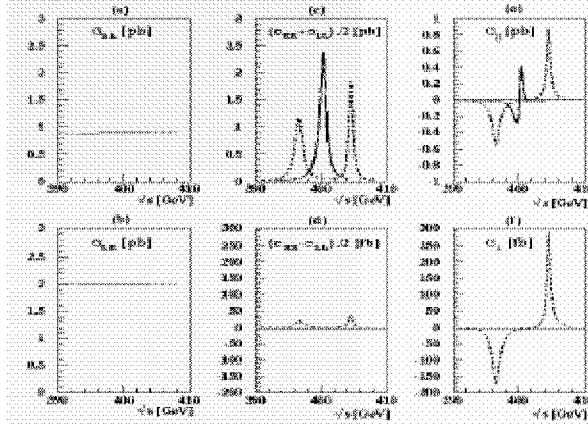

### **Much to do!**

- R&D for long baseline detectors
- target stations & beam designs for stopped muon physics
- beam design for near-by neutrino physics
- nufact target tests (collection system must be integrated)
- cooling test facility
- etc etc

**project has many facets; ideal to European competence**

#### **world wide:**

communication takes place already (NUFACT series) MICE is international, etc...

Alain Blondel



## **Conclusions**

**NuFact Complex addresses essential physics issues that will not be addressed by High Energy colliders (LHC, NLC/Tesla):**

- lepton number violation ( $\nu$ -mixing, rare muon&K decays)
- new CP violation phenomena (neutrinos, Higgses)

**and offers a large variety of physics opportunities and synergies**

- high intensity neutrino physics
- nuclear physics (muonic atoms, radioactive nuclei, etc..)

### **AN ATTRACTIVE OPTION FOR EUROPE AFTER LHC**

**Studies have become considerably more concrete over the last year thanks to an active and motivated community**

**There is a scheme for a NuFact that seems well adapted for CERN. Much work remains to be done to ascertain performance and.. Simply learn how a muon machine could work**

Alain Blondel

