

Advanced School and Conference on Non-commutative Geometry

(9 - 27 August 2004)

Algebraic geometry

T. Ekedahl

Department of Mathematics
Stockholm University
SE-106 91 Stockholm
Sweden

These are preliminary lecture notes, intended only for distribution to participants

Commutative geometry
Trieste summer school

Torsten Ekedahl
Stockholm University

Aug 12, 2004

Schedule

1. Introduction
2. More introduction
3. Schemes, **Spec**, and **Proj**
4. **Spec** and **Proj** for modules
5. Projective space and line bundles
6. Vector bundles
7. Elliptic curves
8. Vector bundles and stability

First lecture

Algebraic geometry

Algebraic geometry:

Part of general geometry; analytic, differential, projective geometry, topology.

Algebraic geometry:

- “Controlled” nice geometry (vs. e.g. fractal geometry).
- (Can use) purely algebraic methods.
- \Rightarrow Applications to arithmetic, non-commutative algebraic geometry. . .

Geometry \longleftrightarrow Algebra

$$x^2 + y^2 = 1:$$

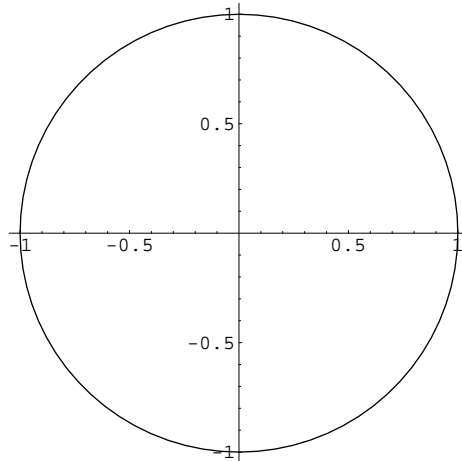

$$(x^2 - y^2)x^2 + y^6 = 0:$$

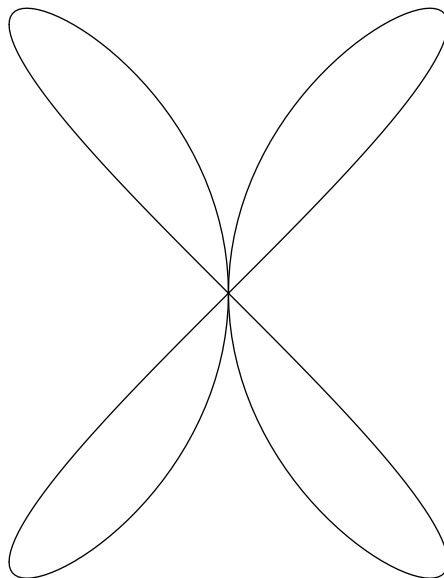

How to tell shape from equation?

Linear algebra

- Line: $ax + by = c$

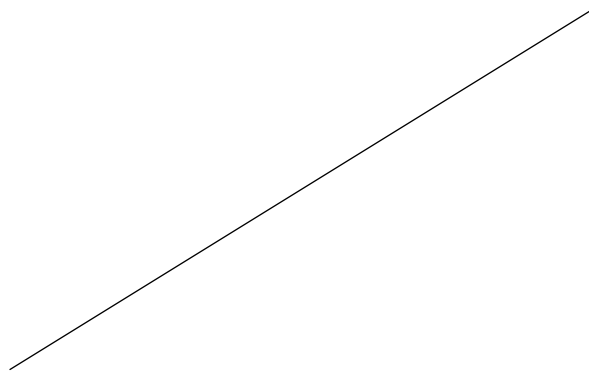

- Lines: $\begin{cases} ax + by = c \\ a'x + b'y = c' \end{cases}$

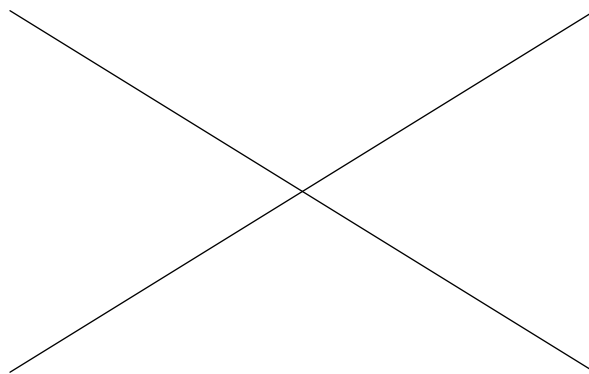

These equations can easily be solved algebraically.

- Line-plane:
$$\begin{cases} a_1x + b_1y + c_1z = d_1 \\ a_2x + b_2y + c_2z = d_2 \\ ax + by + cz = d \end{cases}$$

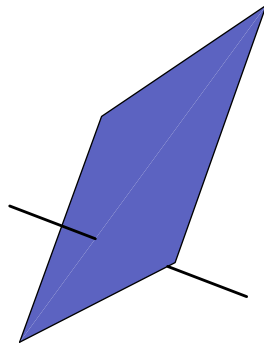

- Plane-plane:
$$\begin{cases} a_1x + b_1y + c_1z = d_1 \\ a_2x + b_2y + c_2z = d_2 \end{cases}$$

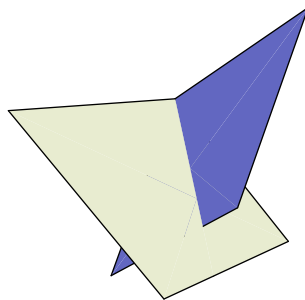

Drawing curves, real case

Real solutions: $y^2 = f(x)$

$$\text{Solutions: } y = \begin{cases} 0 & \text{if } f(x) = 0 \\ \pm\sqrt{f(x)} & \text{if } f(x) > 0 \\ - & \text{if } f(x) < 0 \end{cases}$$

- $x^2 + y^2 = 1 \iff$
 $y^2 = 1 - x^2 = (1 - x)(1 + x),$
 $x \in [-1, 1].$
- $y^2 = x^3 - 1 = (x - 1)((x + 1/2)^2 + 3/4),$
 $x \in [1, \infty[.$



- $y^2 = x^3 - x = (x - 1)x(x + 1),$
 $x \in [-1, 0] \cup [1, \infty[.$

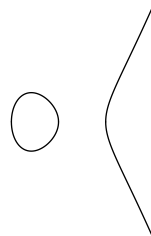

Drawing curves, complex case

$y^2 = x$, $x, y \in \mathbb{C}$ always solvable.

Furthermore:

Lemma 0.1 *Let $f: U \rightarrow \mathbb{C}^*$ be a continuous function from an open subset U of \mathbb{C} and $\gamma: [a, b] \rightarrow U$ also continuous. Then for any $c \in \mathbb{C}$ with $c^2 = f(\gamma(a))$ there is a unique continuous $\rho: [a, b] \rightarrow \mathbb{C}^*$ with*

- $\rho^2(t) = f(\gamma(t))$ for all $t \in [a, b]$,
- $\rho(a) = c$.

End point homotopic curves C and D :

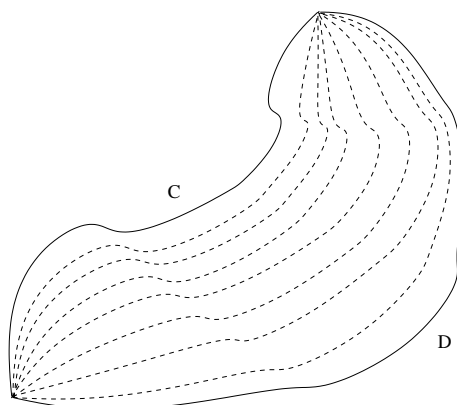

Lemma 0.2 *If f as in Lemma 0.1,*

$\gamma, \gamma': [a, b] \rightarrow U$ are end point homotopic and $\rho^2 = \gamma, \rho'^2 = \gamma'$ with $\rho(a) = \rho'(a)$ then $\rho(b) = \rho'(b)$.

$$y^2 = 1 - x^2, \quad x, y \in \mathbf{C}:$$

$$1 - x^2: \mathbf{C} \setminus \{\pm 1\} \rightarrow \mathbf{C}^*$$

For basepoint choose 0.

$y: \mathbf{C} \setminus \{\pm 1\} \rightarrow \mathbf{C}^*$ well defined once starting value ± 1 and a homotopy class of paths from 1 to x has been chosen.

$$\pm 1 \rightarrow \mp 1 \Rightarrow y \rightarrow -y$$

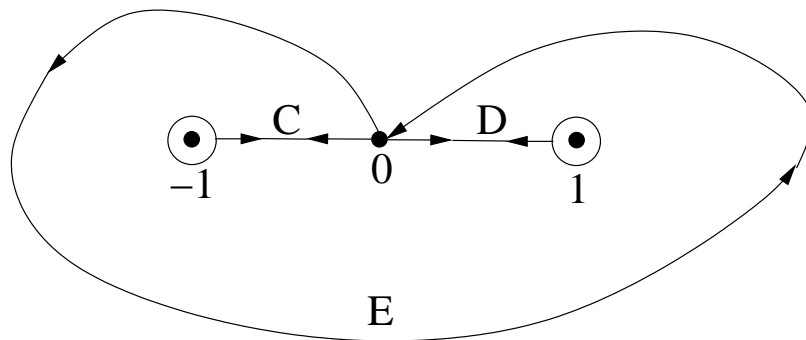

Choose $y(0) = 1$.

$y(D)$:

Around 1, $x - 1 = e^{i\theta}$, $\theta \in [0, 2\pi]$, so
 $\sqrt{x - 1} = e^{i\theta/2}$.

$$-x - 1 = (\sqrt{-x - 1})^2$$

Once around gives $e^{i2\pi/2} = -1$ and hence
the square root changes sign.

Back and forth gives same result so that

$$\boxed{y(D) = -1}$$

Similarly $\boxed{y(C) = -1}$.

Now E is homotopic to the composite, $D \circ C$, of C and D .

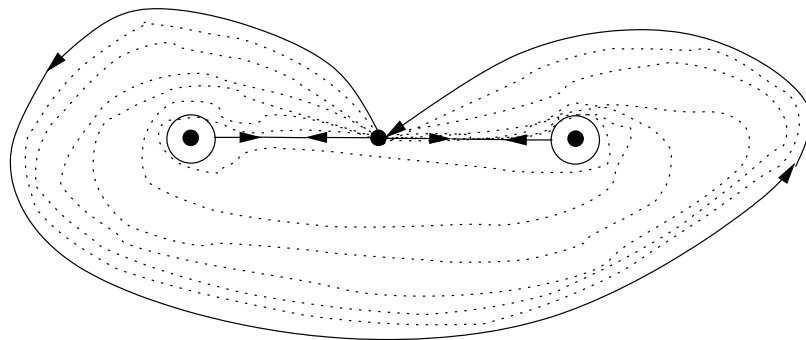

Hence $y(E) = 1$.

This gives that outside of the cutout, $|z| \geq 2$ say,

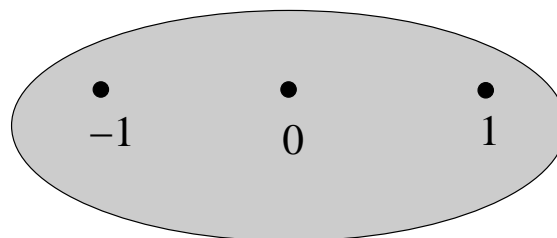

$x^2 - 1$ has two continuous square roots.

Therefore, the subset of the curve $\{(x, y) \in \mathbb{C}^2 \mid x^2 + y^2 = 1\}$ for which $|x| \geq 2$ consists of two copies of $|z| \geq 2$.

What about the inside $|z| \leq 2$? Cut up the disc along $[-1, 1]$. Again the square roots are well-defined away from the cut but are interchanged when passing through the cut.

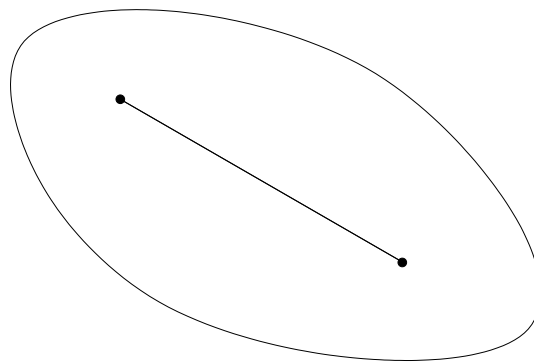

giving as inverse image something like

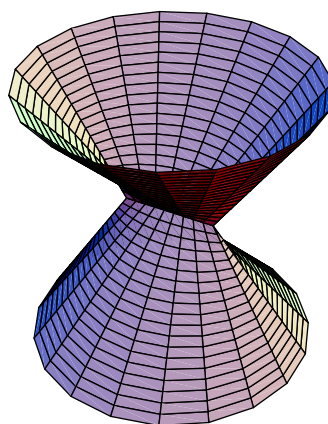

Note that the seeming intersection in the middle is no intersection.

The top part may be pushed through itself.

Cross section:

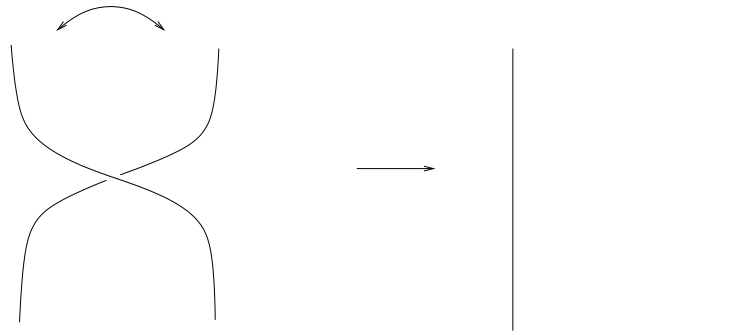

resulting in a cylinder:

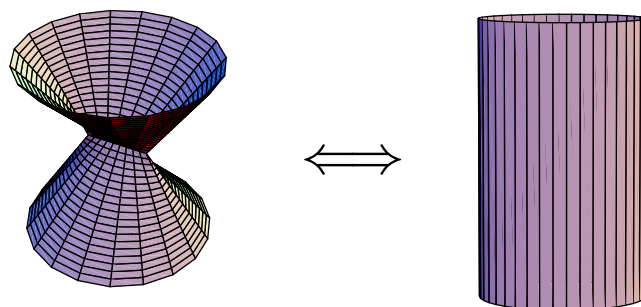

Putting all together gives

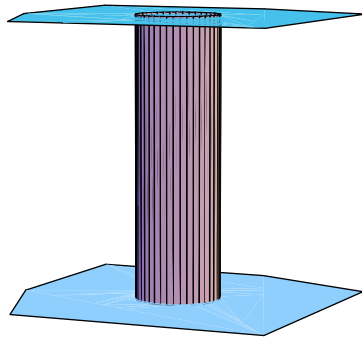

and “folding” the top plane gives a cap of the cylinder

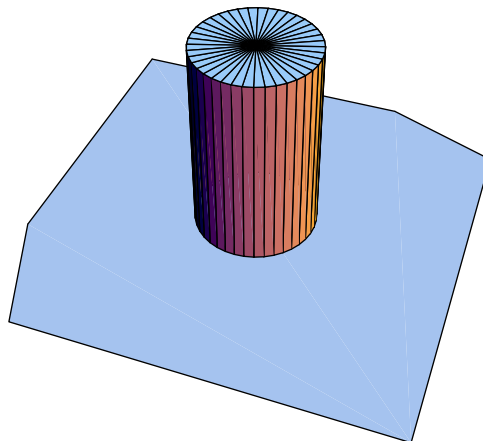

and pushing the cylinder down gives a *punctured* plane (centre missing).

Second lecture

Shape of the curve
 $\{(x, y) \in \mathbf{C} \mid x^2 + y^2 = 1\}$:

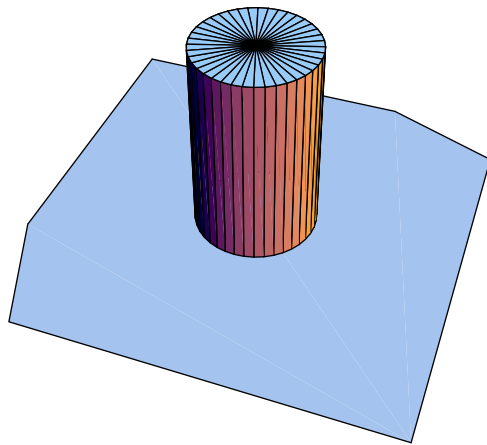

“Topologically” the punctured plane,
 $\mathbf{C} \setminus \{0\}$.
This is true also algebraically:

$$\begin{cases} x^2 + y^2 = 1 \\ y = k(x + 1) \end{cases}$$

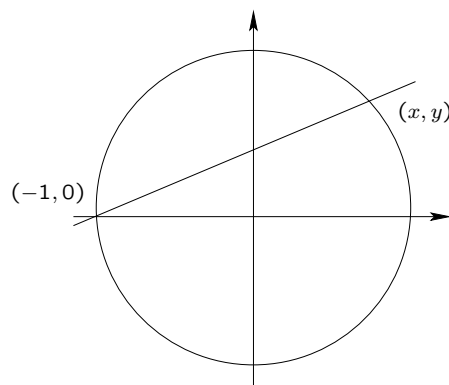

Solution:

$$k \mapsto \left(\frac{1 - k^2}{1 + k^2}, \frac{2k}{1 + k^2} \right)$$

$$(x, y) \mapsto \frac{y}{x + 1}$$

Missing points!

$$\begin{cases} k = \pm i \\ (x, y) = (-1, 0) \end{cases} \rightsquigarrow \text{Projective geometry}$$

$$y^2 = x^4 - 1 = (x \pm 1)(x \pm i)$$

Two cutouts:

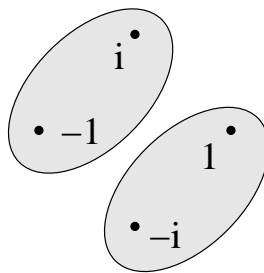

Hence

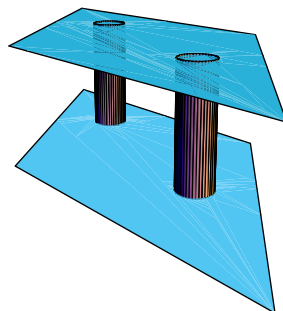

Folding top plane:

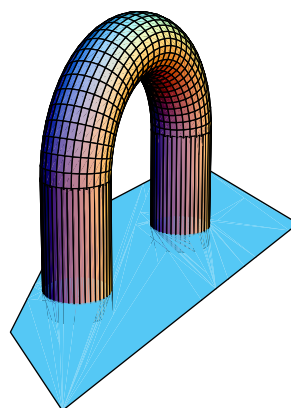

Folding also bottom plane gives,

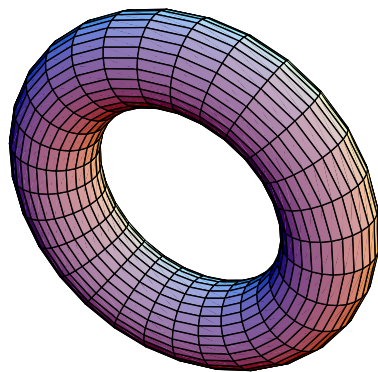

i.e., a torus *with two points missing*.

The story of the missing points

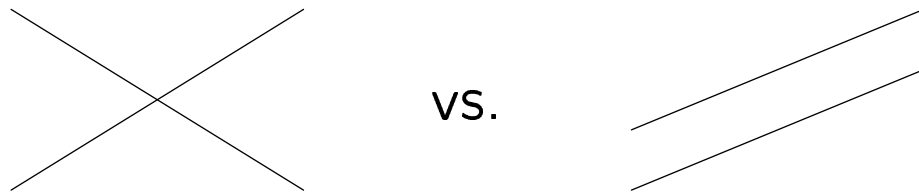

Laws of perspective (Alberti, 1404–1472).

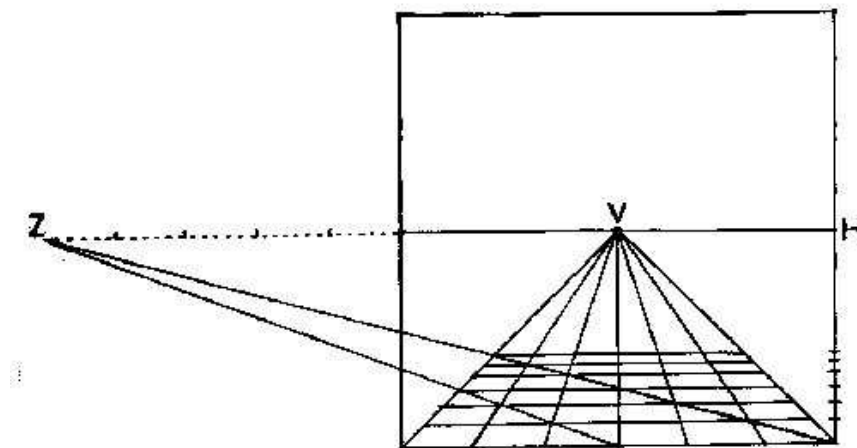

Central projection:

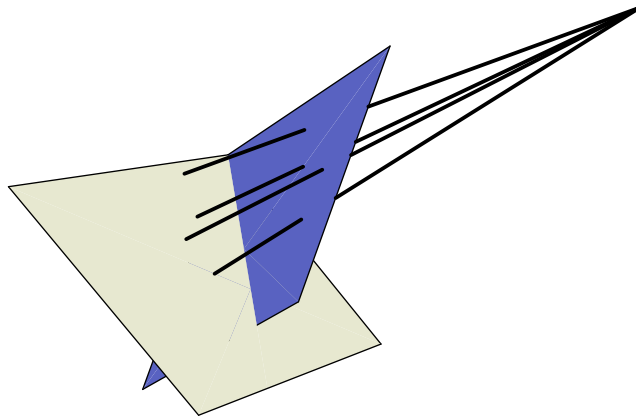

Parametrising a plane in K^3 (K a field):

$$\begin{aligned} K^2 &\rightarrow K^3 \\ (s, t) &\mapsto sv_1 + tv_2 + v_3 \end{aligned}$$

General form for central projection
between parametrised planes:

$$(s, t) \mapsto \left(\frac{a_{11}s + a_{12}t + a_{13}}{a_{31}s + a_{32}t + a_{33}}, \frac{a_{21}s + a_{22}t + a_{23}}{a_{31}s + a_{32}t + a_{33}} \right)$$

Not always defined!

For natural reasons!

Definition 0.3 *i) The n -dimensional projective space over a field K , $\mathbf{P}^n(K)$, is the set of 1-dimensional linear subspaces of K^{n+1} .*

ii) A k -dimensional projective subspace of $\mathbf{P}^n(K)$ consists of the 1-dimensional linear subspaces contained in a linear subspace of dimension $k + 1$.

$\mathbf{P}^2(\mathbf{F}_2)$:

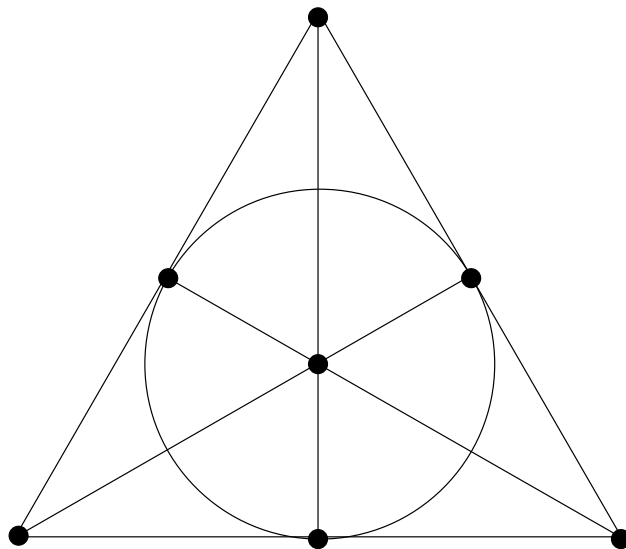

Homogeneous coordinates

$$L \subseteq K^{n+1}, \dim L = 1 \Rightarrow$$

$$L = Kv, 0 \neq v = (a_0, a_1, \dots, a_n)$$

$$Kv = Kv' \iff$$

$$(a'_0, a'_1, \dots, a'_n) = \lambda(a_0, a_1, \dots, a_n), \lambda \neq 0$$

$$(a_0 : a_1 : \dots : a_n) :=$$

equivalence class of (a_0, a_1, \dots, a_n)

$$a_0 \neq 0:$$

$$(a_0 : a_1 : \dots : a_n) = (1 : a_1/a_0 : \dots : a_n/a_0)$$

Unique! $\{(a) \in \mathbf{P}^n(K) \mid a_0 \neq 0\} = K^n.$

$z \neq 0$:

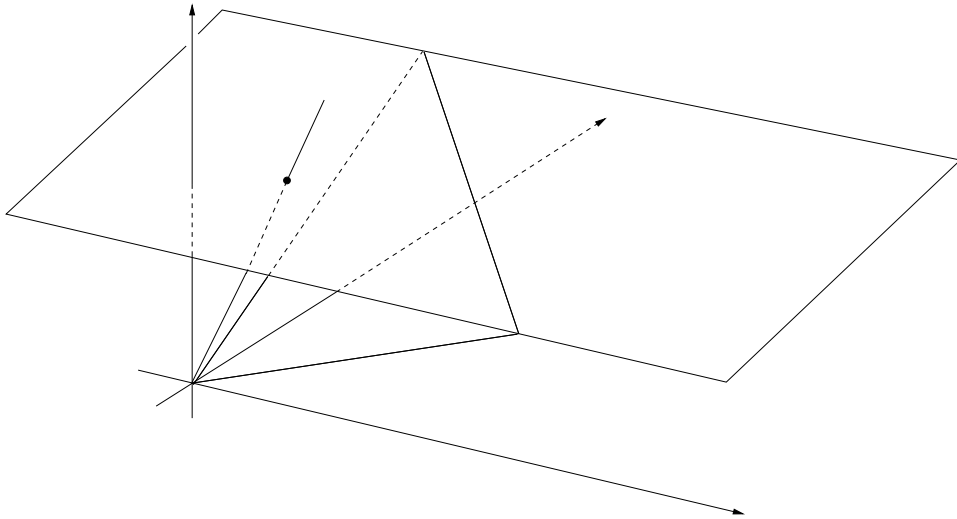

Standard affine patches:

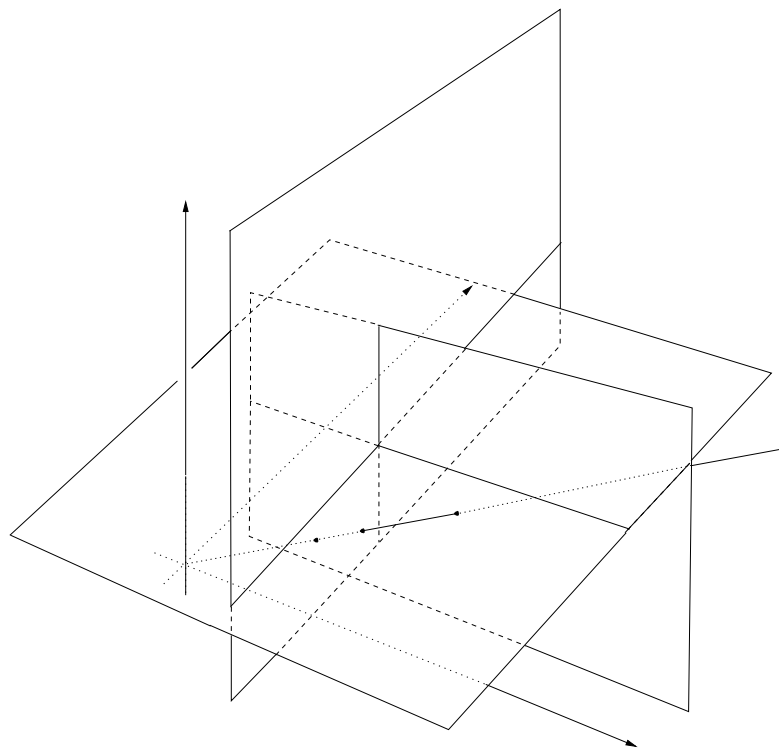

$$(x:y:1) = (x/y:1:1/y) = (1:y/x:1/x)$$

Projective completion

Polynomials not welldefined on $\mathbf{P}^n(K)$.

$\{v \in \mathbf{P}^n(K) \mid f(v) = 0\}$ is welldefined if f is *homogeneous*, i.e.,

$$f(\lambda x_0, \lambda x_1, \dots, \lambda x_n) = \lambda^d f(x_0, x_1, \dots, x_n).$$

$f(x, y, z) = y^2 + x^2 - z^2$: Affine patch $z \neq 0$

$$0 = f(x, y, 1) = y^2 + x^2 - 1 \iff$$
$$y^2 + x^2 = 1$$

Points at infinity:

$$0 = f(x, y, 0) = x^2 + y^2, (\pm i : 1 : 0)$$

Missing points!

$$(x : y : z) = (x/z : y/z : 1)$$

$$f(x, y, z) = z^2 f(x/z, y/z, 1)$$

Adding points at ∞

The projective line

$$\mathbf{P}^1(K) = \{(x:1) \mid x \in K\} \cup \{\infty := (1:0)\}$$

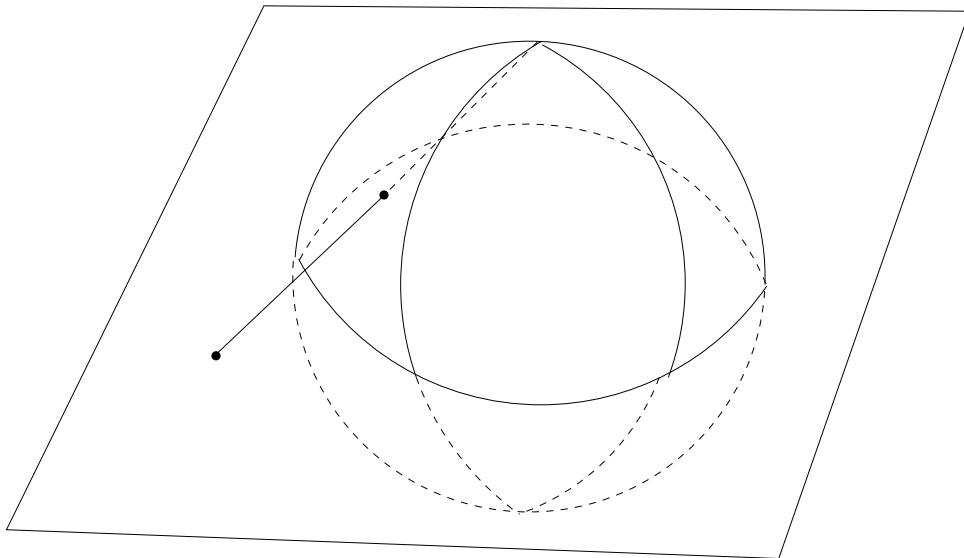

$$\mathbf{P}^1(K) = \{x \mid x \in K\} \cup \{y \mid y \in K\},$$
$$y = 1/x, x = 1/y$$

The circle revisited

Put

$$Q := \{(x:y:z) \in \mathbf{P}^1(K) \mid x^2 + y^2 = z^2\}$$

Inverse maps:

$$\begin{array}{ccc} \mathbf{P}^1(K) & \rightarrow & Q \\ (k:\ell) & \mapsto & (k^2 - \ell^2 : 2k\ell : k^2 + \ell^2) \end{array}$$

and

$$\begin{array}{ccc} Q & \rightarrow & \mathbf{P}^1(K) \\ (x:y:z) & \mapsto & (y:x+z) \end{array}$$

NB: $(-1:0:1) \mapsto (0:0)$, not defined!

For $K = \mathbf{C}$ $(-1:0:1) \mapsto (1:0)$ gives a continuous extension.

Third lecture

Spec and all that

Affine n -dimensional space:

$$\mathbf{A}^n(K) := K^n$$

$$\{\varphi: K[x_1, \dots, x_n] \rightarrow K \mid \varphi \text{ } K\text{-alg. hom.}\} \\ \updownarrow \\ \mathbf{A}^n(K)$$

$$\varphi \leftrightarrow (\varphi(x_1), \dots, \varphi(x_n)) \\ f \in K[x_1, \dots, x_n]$$

$f(a_1, \dots, a_n) \iff \varphi(f) = 0 \iff \varphi$ vanishes on the ideal generated by f .

System of equations $\{f_i\} \leftrightarrow K[x_1, \dots, x_n]/(f_i)$

Pitfalls

$$x^2 = 0 \leftrightarrow K[x]/(x^2)$$

$$x = 0 \leftrightarrow K[x]/(x)$$

$$K[x]/(x^2) \not\cong K[x]/(x)$$

Bijection ($t = x/y$):

$$\begin{array}{ccc} \mathbf{A}^1(K) & \rightarrow & \{(x, y) \in K^2 \mid y^2 = x^3\} \\ t & \mapsto & (t^2, t^3) \end{array}$$

$$K[t] \not\cong K[x, y]/(y^2 - x^3)$$

The “ring side” is in the right!

$$y^2 = x^3:$$

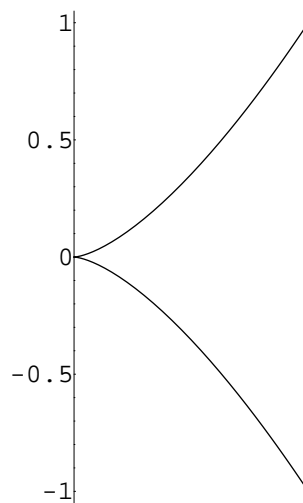

Schemes

... to hard-core pornography. I shall not today attempt further to define the kinds of material I understand to be embraced within that shorthand description; and perhaps I could never succeed in intelligibly doing so. But I know it when I see it,...

Justice Stewart, US Supreme Court

Affine K -schemes:

The opposite category of the category of K -algebras.

$\text{Spec} R$ the affine K -scheme of R .

A^n , the *affine n -space*, is $\text{Spec} K[x_1, \dots, x_n]$.

$\text{Spec} K$, or generally, $\text{Spec} L$, L a K -extension field, are points.

Definition 0.4 *If L is an extension field of K , then an L -point of a K -scheme X is a map $\text{Spec} L \rightarrow X$. The set of L -points of X is denoted $X(L)$.*

$$\mathbf{A}^n(L) = \mathbf{A}^n(L)!!$$

Unqualified “scheme”: The opposite category of commutative rings.

$\text{Spec} \mathbf{Z}(L) \leftrightarrow \mathbf{Z} \rightarrow L$, exactly one for each L .

$\text{Spec} \mathbf{Z}[x](L) \leftrightarrow \mathbf{Z}[x] \rightarrow L$:

- $\text{char } L = 0$, $\mathbf{Q}[x] \rightarrow L \leftrightarrow \mathbf{Q}[x]/(f(x)) \hookrightarrow L$, $f = 0$ or f irred.
- $\text{char } L = p > 0$, $\mathbf{Z}/p\mathbf{Z}[x] \rightarrow L \leftrightarrow \mathbf{Z}/p\mathbf{Z}[x]/(f(x)) \hookrightarrow L$, $f = 0$ or f irred.

General schemes

Remark: The actual gluing maps that can be used to construct schemes are more general than those we shall consider here.

Requirements:

- An affine scheme, $\text{Spec } R$, is a scheme.
- An intersection of “open” affine schemes shall be affine.
- A scheme is a union of open affine schemes.

$$X = \bigcup_i U_i, \quad U_i = \text{Spec } R_i$$

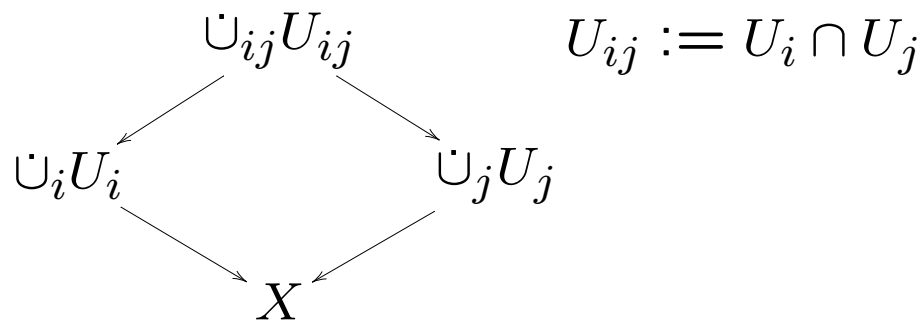

$$U_{ij} = \text{Spec } R_{ij}, \quad U_{ij} \hookrightarrow U_i \leftrightarrow R_i \rightarrow R_{ij}$$

When is $U_{ij} \hookrightarrow U_i$ open?

Example: $R_{ij} = R_i[r_{ij}^{-1}]$, $r_{ij} \in R_i$.

Following seems reasonable:

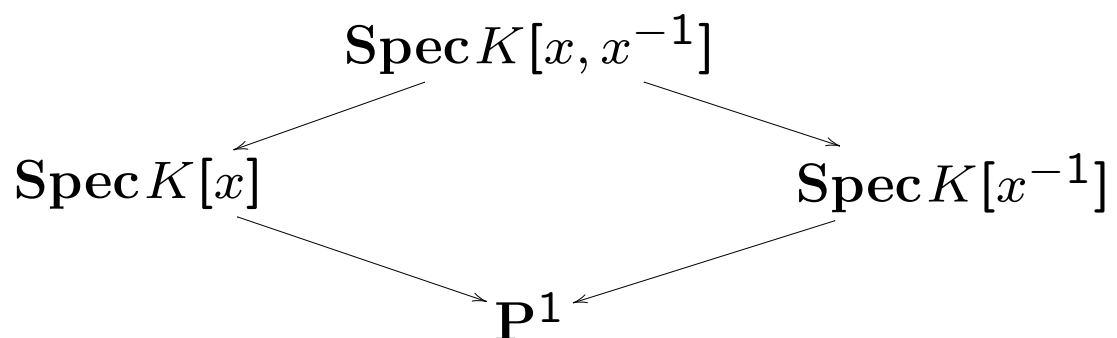

More precisely: Isomorphisms $\psi_{ij}: R_i[r_{ij}^{-1}] \rightarrow R_j[r_{ji}^{-1}]$ with compatibility condition.

\mathbf{P}^1 :

$$\begin{array}{ccc} K[x][x^{-1}] & \rightarrow & K[y][y^{-1}] \\ x & \mapsto & y^{-1} \end{array}$$

Remark: Could have chosen $x \mapsto y$. That would identify K^* with itself but getting two zeroes. This is a *non-separated scheme*. Topologically (over \mathbb{R} or \mathbb{C}) for instance $(1/n)$ converges to *both* zeroes.

Projective space

$$U_i := \text{Spec } K[x_0/x_i, \dots, x_n/x_i],$$

$$K[x_0/x_i, \dots, x_n/x_i] \subset K(x_0, \dots, x_n)$$

$$U_{ij} = \text{Spec } K[x_0/x_i, \dots, x_n/x_i][(x_j/x_i)^{-1}]$$

ψ_{ij} given by

$$\begin{aligned} K[x_0/x_i, \dots, x_n/x_i][(x_j/x_i)^{-1}] &= \\ K[x_0/x_j, \dots, x_n/x_j][(x_i/x_j)^{-1}] & \end{aligned}$$

Separating the rings more

$$U_i := \text{Spec } K[x_{i0}, \dots, \widehat{x_{ii}}, \dots, x_{in}]$$

$$U_{ij} = \text{Spec } K[x_{i0}, \dots, \widehat{x_{ii}}, \dots, x_{in}][x_{ij}^{-1}]$$

$$\psi_{ij}(x_{ik}) = x_{jk}/x_{ji}$$

Remark: Even more natural is to take

$$U_i = \text{Spec } K[x_{i0}, \dots, x_{in}]/(x_{ii} - 1).$$

A K -point $\text{Spec } K \rightarrow \mathbf{P}^n$ lands in one U_i (covering!).

$$\text{Hom}(\text{Spec } K, U_i) = \{(a_0, \dots, \widehat{a_i}, \dots, a_n)\}.$$

$$\text{Different } i: \text{Hom}(\text{Spec } K, U_{ij}) \stackrel{\psi_{ij}}{=} \text{Hom}(\text{Spec } K, U_{ji})$$

$$\text{Hom}(\text{Spec } K, U_{ji}) \Rightarrow (a_0 : \dots : 1 : \dots : a_n)$$

welldefined.

Projective spectrum

Let $R = \bigoplus_i R_i$ be a graded K -algebra. Assume (for simplicity) that R is generated by a finite set $\{f_i\}$ of positively graded elements, $d_i := \deg f_i$. Then $R[f_i^{-1}]$ is a graded ring, let $R[f_i^{-1}]_0$ be the subring of degree 0 elements.

$$U_i := \text{Spec } R[f_i^{-1}]_0$$

$$U_{ij} := \text{Spec } R[f_i^{-1}]_0[(f_j^{d_i}/f_i^{d_j})^{-1}]$$

$$\begin{aligned} \psi_{ij}: R[f_i^{-1}]_0[(f_j^{d_i}/f_i^{d_j})^{-1}] &= R[(f_i f_j)^{-1}]_0 = \\ &= R[f_j^{-1}]_0[(f_i^{d_j}/f_j^{d_i})^{-1}] \end{aligned}$$

The *projective spectrum*:

$$\mathbf{Proj} R := \cup_i U_i$$

Examples

- $R = K[t]$, $\deg t = 1$.
 $\{t\}$ set of generators. $R[t^{-1}] = K[t, t^{-1}]$.
 $R[t^{-1}]_0 = K$, $\boxed{\text{Proj } R = \text{Spec } K}$.
 - $R = K[x_0, \dots, x_n]$, $\deg x_i = 1$.
 $\{x_i\}$ generators.
 $R[x_i^{-1}]_0 = K[x_0/x_i, \dots, \widehat{x_i/x_i}, \dots, x_n/x_i]$.
 $\boxed{\text{Proj } R = \mathbf{P}^n}$.
 - $R = K[x, y, z]$, $\deg(x, y, z) = (2, 3, 1)$.
 - $R[x^{-1}]_0 = K[z^2/x, y^2/x^3, yz/x^2] = K[r, s, t]/(rs - t^2)$,
not a polynomial ring.
 - $R[y^{-1}]_0 = K[z^3/y, x^3/y^2, xz/y] = K[a, b, c]/(ab - c^3)$,
not a polynomial ring.
 - $R[z^{-1}]_0 = K[x/z^2, y/z^3] = K[u, v]$.
- $\boxed{\text{Proj } R =: \mathbf{P}(2, 3, 1)}$, a weighted projective space

Points of $\mathbb{P}(2, 3, 1)$

- $U_x(K) = \{(r, s, t) \in K^3 \mid rs = t^2\}$.
- $U_y(K) = \{(a, b, c) \in K^3 \mid ab = c^3\}$.
- $U_z(K) = \{(u, v) \in K^2\}$

Gluing:

- $U_x(K) \cap U_y(K)$: $bs = 1$,
 $r = c^2/b, t = c/b, c = t/s, a = rt/s$
- $U_x(K) \cap U_z(K)$: $ru = 1$,
 $v = t/r^2, s = v^2/u^3, t = v/u^2$
- $U_y(K) \cap U_z(K)$: $av = 1$,
 $u = c/a, b = u^3/v^2, c = u/v$

Weighted homogeneous coordinates:

$$(x:y:z) = (\lambda^2 x : \lambda^3 y : \lambda z), \lambda \in K^*.$$

- $x \neq 0$:
 $(x:y:z) \mapsto (z^2/x, y^2/x^3, yz/x^2) \in U_x(K)$
- $y \neq 0$:
 $(x:y:z) \mapsto (z^3/y, x^3/y^2, xz/y) \in U_y(K)$
- $z \neq 0$:
 $(x:y:z) \mapsto (x/z^2, y/z^3) \in U_z(K)$

This gives a bijection,
homogeneous coord's $\leftrightarrow \mathbf{P}(2, 3, 1)(K)$ if
 K is algebraically closed.

General homogeneous coordinates

Definition 0.5 R as before, $X := \text{Proj } R$,
A graded K -algebra homomorphism $R \rightarrow K[t]$,
 $\deg t = 1$, is irrelevant if it is zero on positive
elements.

$R \rightarrow K[t]$ not irrelevant \Rightarrow some $f_i \not\mapsto 0$
 $\leadsto R[f_i^{-1}] \rightarrow K[t, t^{-1}] \leadsto R[f_i^{-1}]_0 \rightarrow K$
 $\leadsto x \in U_i(K)$

“Independent” of $i \leadsto x \in X(K)$.

$\lambda \in K^*$: $\varphi_\lambda: K[t] \rightarrow K[t]$, $\varphi_\lambda(t) = \lambda t$.
 $f: R \rightarrow K[t]$ and $\varphi_\lambda \circ f$ give same x .

Proposition 0.6 If K is algebraically closed then
this gives a bijection between $X(K)$ and non-
irrelevant $R \rightarrow K[t]$ modulo the action of the
 φ_λ .

Fourth lecture

Quasi-coherent sheaves

Definition 0.7 *i) Let R be a commutative ring. A quasi-coherent sheaf on $X := \text{Spec } R$ is an R -module M and similarly for morphisms between them. A global section of M is a module homomorphism $R \rightarrow M$. The set of global sections is denoted $M(X)$.*

ii) If $f: R \rightarrow S$ is a ring homomorphism (of commutative rings) and M a quasi-coherent sheaf on $\text{Spec } R$, then $f^ M := S \otimes_R M$.*

Note: $R \rightarrow M \leftrightarrow m \in M$ by $1 \mapsto m$.

Definition 0.8 Let $X = (\{U_i\}, \{U_{ij}\}, \psi_{ij})$, $U_i := \text{Spec } R_i$, $U_{ij} := \text{Spec } R_{ij}$, $\psi_{ij}: U_{ij} \cong U_{ji}$, be a scheme. A quasi-coherent sheaf on X consists of the choice of a quasi-coherent sheaf M_i on U_i and the following data

- isomorphisms $\rho_{ij}: M_{ij} \rightarrow \psi_{ij}^* M_{ji}$, where $M_{ij} := s^* M_i$ with $s: U_{ij} \rightarrow U_i$ the “inclusions”,
- a compatibility $\rho_{ik} = \rho_{jk} \circ \rho_{ij}$ on $U_{ijk} := \text{Spec } R_{ij} \otimes_{R_j} R_{jk}$.

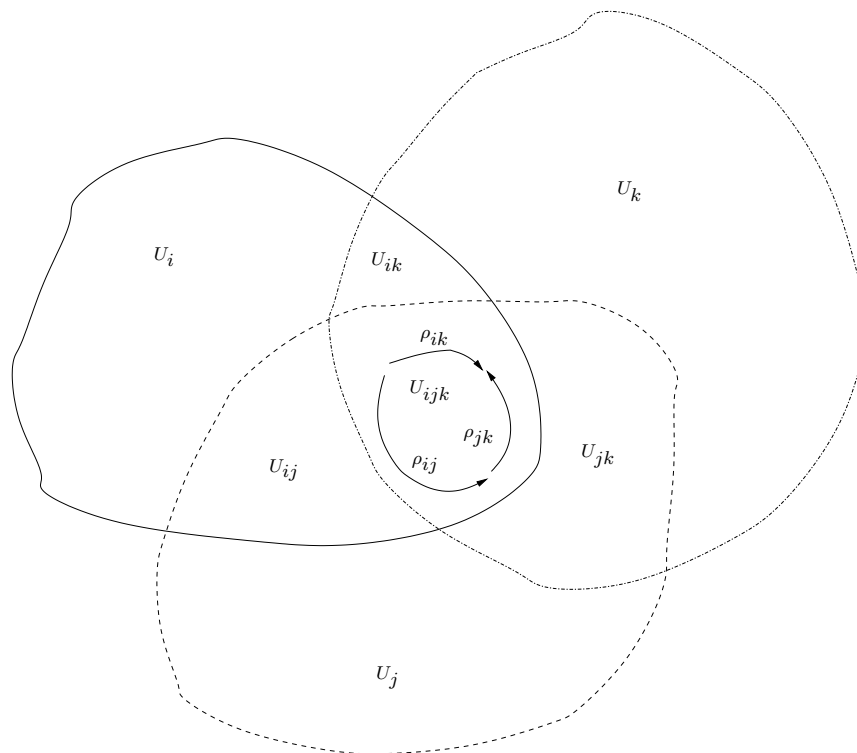

Examples

- $M_i = R_i$. This is the *structure sheaf* denoted \mathcal{O}_X .
- All constructions of modules that “commute with pullbacks” (i.e., with f^*). They include *direct sum*, $(\mathcal{M}, \mathcal{N}) \mapsto \mathcal{M} \oplus \mathcal{N}$ and *tensor products*, $(\mathcal{M}, \mathcal{N}) \mapsto \mathcal{M} \otimes_{\mathcal{O}_X} \mathcal{N}$. These are constructed requiring for instance $(\mathcal{M} \oplus \mathcal{N})_i = \mathcal{M}_i \oplus \mathcal{N}_i$.
- Let $x \in X(L)$. We define \mathbf{k}_x as follows: If $x \in U_i(L)$ then $(\mathbf{k}_x)_i := R_i/m_i$, where m_i is the kernel of $R_i \rightarrow L$. If $x \notin U_i(L)$, $(\mathbf{k}_x)_i = 0$. Similarly $m_x \subseteq \mathcal{O}_X$ is defined by $(m_x)_i = m_i$ resp. R_i .

Examples, cont'd

The category of quasi-coherent sheaves have most of the properties of the category of R -modules:

- Abelian category:
 $0 \rightarrow \mathcal{M} \rightarrow \mathcal{N} \rightarrow \mathcal{P} \rightarrow 0$
is exact precisely when
 $0 \rightarrow \mathcal{M}_i \rightarrow \mathcal{N}_i \rightarrow \mathcal{P}_i \rightarrow 0$ is.
- Enough injective objects.
- Exact directed limits.
- *Not* enough projective objects (in general).

Global sections:

$$\Gamma(X, \mathcal{M}) = \mathcal{M}(X) := \text{Hom}(\mathcal{O}_X, \mathcal{M}).$$

In general *not* exact:

$$0 \rightarrow \mathcal{M} \rightarrow \mathcal{N} \rightarrow \mathcal{P} \rightarrow 0 \text{ exact} \Rightarrow$$

$$0 \rightarrow \mathcal{M}(X) \rightarrow \mathcal{N}(X) \rightarrow \mathcal{P}(X) \text{ exact.}$$

The projective line

$$U_1 := \text{Spec } K[x], \quad U_2 := \text{Spec } K[x^{-1}].$$

\mathcal{M} : M_1 $K[x]$ -module, M_2 $K[x^{-1}]$ -module,
 $\rho: M_1[x^{-1}] \cong M_2[x]$.

- $x = (0:1)$.
 $(\mathbf{k}_x)_1 = K[x]/(x)$, $(\mathbf{k}_x)_2 = 0$.
- $x = (1:0)$.
 $(\mathbf{k}_x)_1 = 0$, $(\mathbf{k}_x)_2 = K[x^{-1}]/(x^{-1})$.
- $x = (\lambda:1)$, $\lambda \neq 0$.
 $(\mathbf{k}_x)_1 = K[x]/(x - \lambda)$,
 $(\mathbf{k}_x)_2 = K[x^{-1}]/(x^{-1} - \lambda^{-1})$,
 $\rho = \overline{id}$.

$$\mathcal{M} = \mathcal{O}_{\mathbf{P}^1}(n):$$

$$\mathcal{M}_1 = K[x], \mathcal{M}_2 = K[x^{-1}], \rho(1) = x^{-n}.$$

$s: \mathcal{O}_{\mathbf{P}^1} \rightarrow \mathcal{O}_{\mathbf{P}^1}(n)$ global section.

$$s(1) =: p(x) \in M_1, s(1) =: q(x^{-1}) \in M_2,$$

$$q(x^{-1}) = \rho(p(x)) = x^{-n}p(x).$$

- $n < 0$: $x^{-n}p(x) \in xK[x]$,
 $q(x^{-1}) \in K[x^{-1}]$,
 $p = q = 0$.
- $n \geq 0$: $x^{-n}p(x) \in x^{-n}K[x]$,
 $q(x^{-1}) \in K[x^{-1}]$,
 $\deg q \leq n$.
- $n = 0$: $q = 1$ gives isomorphism
 $\mathcal{O}_{\mathbf{P}^1} \cong \mathcal{O}_{\mathbf{P}^1}(0)$.

Proj of modules

R graded K -algebra (as before) and M a graded R -module.

$$X := \mathbf{Proj} R, \mathcal{M} = \mathbf{Proj} M:$$

$$\mathcal{M}_i := M[f_i^{-1}]_0,$$

$$\rho_{ij}: M[f_i^{-1}]_0[(f_j^{d_i}/f_i^{d_j})^{-1}] = M[(f_i f_j)^{-1}]_0 \\ M[f_j^{-1}]_0[(f_i^{d_j}/f_j^{d_i})^{-1}].$$

Examples for \mathbf{P}^1 :

- Shift of M , $M(n): M(n)_i = M_{n+i}$,
 $R = K[x, y]$, $M = K[x, y]$,
 $\mathbf{Proj} M(n) = \mathcal{O}_{\mathbf{P}^1}(n)$.
- $R = K[x, y]$, $M = K[t]$,
 $x \cdot 1 = at$, $y \cdot 1 = bt$, $(a, b) \neq (0, 0)$,
 $\mathbf{Proj} M = \mathbf{k}_x$, $x = (a:b)$.

$$m \in M_k \rightsquigarrow m/1 \in \Gamma(X, \mathbf{Proj} M(k)).$$

Examples for \mathbf{P}^n ($R = K[x_0, \dots, x_n]$):

- $M = K[x_0, \dots, x_n]$,
 $\mathcal{O}_{\mathbf{P}^n}(k) = \mathbf{Proj} M(k)$,
 $K[x_0, \dots, x_n]_k \rightarrow \Gamma(\mathbf{P}^n, \mathcal{O}(k))$,
 $K[x_0, \dots, x_n]_k$ homogeneous
polynomials of degree k .
- M graded R -module:
 $\mathbf{Proj} M(k) = (\mathbf{Proj} M) \otimes_{\mathcal{O}_{\mathbf{P}^n}} \mathcal{O}_{\mathbf{P}^n}(k)$.
- $\mathcal{O}_{\mathbf{P}^n}(k) \otimes_{\mathcal{O}_{\mathbf{P}^n}} \mathcal{O}_{\mathbf{P}^n}(l) \cong \mathcal{O}_{\mathbf{P}^n}(k + l)$.
- $\mathcal{O}_{\mathbf{P}^n} \cong \mathcal{O}_{\mathbf{P}^n}(0)$.

General properties

$X := \mathbf{Proj} R$, R graded (as before).

- $M \mapsto \mathbf{Proj} M$ is exact.
- $\mathbf{Proj} M = 0 \iff \forall m \in M_k, f \in R_+ \exists n: f^n m = 0$.
- If M is f.g. then $M_k \rightarrow \Gamma(X, \mathbf{Proj} M(k))$ isomorphism for $k \gg 0$.
- Every quasi-coherent sheaf on X is of the form $\mathbf{Proj} M$.

Kähler differentials.

R K -algebra. R -module $\Omega_{R/K}$:
Generators $df, f \in R$. Relations:

- $d(f + g) = df + dg$.
- $d(fg) = fdg + gdf$.
- $d\lambda = 0, \lambda \in K$.

$f \in R$: $\Omega_{R[f^{-1}]/K} = \Omega_{R/K}[f^{-1}] \simeq \Omega_{X/K}$,
 X K -scheme
($d(g/f^n) = f^{-n}dg - n g f^{-n-1}df$).

The projective line

$R = K[x]$: $d(p(x)) = p'(x)dx$, $\Omega_{K[x]/K}$
free on dx .

$\Omega_{\mathbf{P}^1/K}$: $K[x]dx$, $K[x^{-1}]d(x^{-1})$,

$d(1/x) = x^{-2}dx$,

$\rho(dx) = x^2d(1/x) \rightsquigarrow \Omega_{\mathbf{P}^1/K} \cong \mathcal{O}_{\mathbf{P}^1}(-2)$.

Fifth lecture

Definition 0.9 *i) A scheme is noetherian if it can be given by noetherian gluing data (U, V, s, t) , i.e., $U = \text{Spec } R$ for a noetherian ring R .*

ii) A quasi-coherent sheaf on X is coherent if it is the form (M, ρ) with M a finitely generated R -module for some noetherian gluing data.

Assume $U = \dot{\cup}_i U_i$:

noetherian \iff finite indexset and R_i
noetherian

coherence $\iff M_i$ finitely generated.

From now on we shall assume that all schemes are noetherian.

Line bundles

Definition 0.10 A line bundle or invertible sheaf on a scheme X is a quasi-coherent sheaf \mathcal{L} such that there is another quasi-coherent sheaf \mathcal{L}^* so that $\mathcal{L}^* \otimes_{\mathcal{O}_X} \mathcal{L} \cong \mathcal{O}_X$.

Recall: $\mathcal{O}_{\mathbb{P}^n}(k) \otimes_{\mathcal{O}_{\mathbb{P}^n}} \mathcal{O}_{\mathbb{P}^n}(\ell) \cong \mathcal{O}_{\mathbb{P}^n}(k + \ell)$,
 $k := -\ell$

R Dedekind ring: \mathfrak{n} fractionary ideal
 $\mathfrak{n}^{-1} := \{r \in \text{Frac } R \mid r\mathfrak{n} \subseteq R\}$

$$\begin{array}{ccc} \mathfrak{n}^{-1} \otimes_R \mathfrak{n} & \rightarrow & \mathfrak{n}^{-1} \mathfrak{n} \\ r \otimes s & \mapsto & rs \end{array}$$

is an isomorphism $\Rightarrow \mathfrak{n}$ line bundle
 $(\mathfrak{n}^{-1} \mathfrak{n} = R \iff R \text{ is Dedekind})$

$\text{Pic}(X) :=$ iso classes of line bundles:
 Group under $\otimes_{\mathcal{O}_X}$

Proposition 0.11 *Line bundles are coherent.*

Line bundles on Dedekind ring R :

Fractionary ideals \leadsto

$$\text{Pic}(\text{Spec } R) = \text{Cl}(R)$$

Line bundles on \mathbf{A}^1 : Only $\mathcal{O}_{\mathbf{A}^1}$ (PID).

Line bundles on \mathbf{P}^1 :

Restriction to patches trivial

$$\rho: K[x, x^{-1}] \cong K[x, x^{-1}], \rho(1) = \lambda x^n$$

Mult. by λ on first patch $\leadsto \rho(1) = x^n \leadsto$

$$\mathcal{O}_{\mathbf{P}^1}(n) \Rightarrow \text{Pic}(\mathbf{P}^1) = \mathbf{Z}$$

Čech cocycles

Assume gluing data:

$$(\dot{\cup}_i U_i, \dot{\cup}_{ij} U_{ij}, s, t), \quad s: U_{ij} \rightarrow U_i, \quad t: U_{ij} \rightarrow U_j.$$

Assume \mathcal{L} line bundle and

$$\begin{aligned} \mathcal{L}|_{U_i} &\cong R_i e_i, \quad U_i = \mathbf{Spec} R_i, \\ \rho_{ij}(e_i) &= u_{ij} e_j, \quad e_{ij} \in R_{ij}^*, \quad U_{ij} = \mathbf{Spec} R_{ij}, \end{aligned}$$

Cocycle condition:

$$u_{ik} = u_{jk} u_{ij} \in R_{ijk} := R_{ij} \otimes_{R_j} R_{jk}.$$

$$e'_i = u_i e_i \rightsquigarrow u'_{ij} = u_j u_i^{-1} u_{ij}$$

u_{ij} and u'_{ij} define same line bundle

Projective space

$$M = K[x_0, \dots, x_n](m):$$

$$M[x_i^{-1}]_0: \text{generator } x_i^{-m}$$

$$\rho_{ij}(x_i^{-m}) = (x_i/x_j)^m x_i^{-m}$$

$$\Gamma(\mathbf{P}^n, \mathcal{O}_{\mathbf{P}^n}(m)):$$

$$s \in \Gamma(\mathbf{P}^n, \mathcal{O}_{\mathbf{P}^n}(m)) \Rightarrow s_i = p_i x_i^{-m},$$

$$p_i \in K[x_0/x_i, \dots, x_n/x_i]$$

$$s_j = \rho_{ij}(s_i) \Rightarrow$$

$$p_j = (x_i/x_j)^m p_i \Rightarrow x_j^m p_j = x_i^m p_i$$

$$\deg p_j \leq m$$

$$K[x_0, \dots, x_n]_m = M_0 \rightarrow \Gamma(\mathbf{P}^n, \mathcal{O}_{\mathbf{P}^n}(m)) \Rightarrow$$

$$\Gamma(\mathbf{P}^n, \mathcal{O}_{\mathbf{P}^n}(m)) = K[x_0, \dots, x_n]_m$$

Line bundle \mathcal{L} on \mathbf{P}^n :

Line bundle on \mathbf{A}^n trivial:

$K[x_0, \dots, x_n]$ UFD.

$\Rightarrow \mathcal{L}$ determined by

$$u_{ij} \in K[x_0/x_i, \dots, x_n/x_i][(x_j/x_i)^{-1}]$$

$$u_{ij} = \lambda_{ij}(x_i/x_j)^{n_{ij}}, \lambda_{ij} \in K^*$$

Cocycle condition \leadsto

$$\lambda_{ij} = \lambda_j/\lambda_i \leadsto u_{ij}(x_i/x_j)^{n_{ij}}$$

Cocycle condition \iff

$$(x_i/x_k)^{n_{ik}} = (x_j/x_k)^{n_{jk}}(x_i/x_j)^{n_{ij}} \iff$$

$$\begin{cases} n_{ik} = n_{ij} \\ n_{ik} = n_{jk} \\ n_{jk} = -n_{ij} \end{cases} \iff n_{ij} = m, i < j$$

Conclusion $\mathcal{L} \cong \mathcal{O}_{\mathbf{P}^n}(m)$

Maps to projective space

$V \subset K^{n+1}$, hyperplane (i.e., $\dim V = n$),
 $V \mapsto V^\perp := \{u \in K^{n+1} \mid \forall v \in V: \langle u, v \rangle = 0\}$
 lines \leftrightarrow hyperplanes

X K -scheme,
 \mathcal{L} line bundle on X , $s_0, \dots, s_n \in \Gamma(X, \mathcal{L}) \rightsquigarrow$
 $\varphi: \mathcal{O}^{n+1} \xrightarrow{(s_0, \dots, s_n)} \mathcal{L}$

Definition 0.12 *The s_i generate \mathcal{L} if φ is surjective.*

Idea: $x \in X(K)$, $\mathcal{L}_x := x^*(\mathcal{L})$ 1-dimensional,
 $x^*(\varphi): K^{n+1} \rightarrow \mathcal{L}_x$ surjective \Rightarrow
 kernel hyperplane $H_x \rightsquigarrow$

$$\begin{array}{ccc} X(K) & \rightarrow & \mathbf{P}^n(K) \\ x & \mapsto & H_x^\perp \end{array}$$

should come from $X \rightarrow \mathbf{P}^n$

Remark: For this reason sometimes
 $\mathbf{P}^n(K) := \{\text{hyperplanes} \subset K^{n+1}\}$

More concretely:

$$s_i^x \in \mathcal{L}_x, \dim \mathcal{L}_x = 1 \Rightarrow$$

$$\exists i_0: s_{i_0}^x \neq 0 \Rightarrow \mathcal{L}_x = K s_{i_0}^x \Rightarrow s_i^x = \lambda_i s_{i_0}^x:$$

$$z \mapsto (\lambda_0 : \dots : \lambda_n)$$

X_i : open subscheme where

$s_i: \mathcal{O}_X \rightarrow \mathcal{L}$ is iso.

$$X = \mathbf{Spec} R, \mathcal{L} = \mathcal{O}_X \Rightarrow$$

$$s_i \in R \Rightarrow X_i = \mathbf{Spec} R[s_i^{-1}]$$

In general exists gluing data

$(\cup_k U_k, \cup_{kl} U_{kl})$ such that

$$\mathcal{L}|_{U_k} \cong \mathcal{O}_{U_k} \Rightarrow X_i \cap U_k = \mathbf{Spec} R_k[s_i^{-1}]$$

On X_i $\mathcal{L} = \mathcal{O}_{s_i} \Rightarrow s_j = f_j^i s_i, f_j^i \in \Gamma(X_i, \mathcal{O}_{X_i})$

$$f \in \Gamma(Y, \mathcal{O}_Y) \leftrightarrow f: Y \rightarrow \mathbf{A}^1:$$

$$f \leftrightarrow K[t] \rightarrow R \leftrightarrow \mathbf{Spec} R \rightarrow \mathbf{A}^1$$

Gives $f^i: X_i \xrightarrow{(f_0^i, \dots, f_n^i)} \mathbf{A}^n \subset \mathbf{P}^n$

symbolically: $x \mapsto (f_0^i(x), \dots, f_n^i(x))$
lies in i 'th affine patch ($f_i^i = 1$)

On $X_i \cap X_j$ $f^i = f^j \rightsquigarrow f: X \rightarrow \mathbf{P}^n$.

Properties:

- $f^* \mathcal{O}_{\mathbf{P}^n}(1) = \mathcal{L}$.
- $x_i \in \Gamma(\mathbf{P}^n, \mathcal{O}_{\mathbf{P}^n}(1))$, $s_i = f^* x_i$.
- This characterises f

Examples

- $X = \mathbf{P}^1$, $\mathcal{L} = \mathcal{O}_{\mathbf{P}^1}(n)$, $x_0^n, x_0^{n-1}x_1, \dots, x_1^n$
 $(s:t) \mapsto (s^n : s^{n-1}t : \dots : t^n)$

- $x = (a_0 : a_1 : \dots : a_n) \in \mathbf{P}^n(\mathbf{Q})$
 $a_i \in L := \mathbf{Z}a_0 + \dots + \mathbf{Z}a_n$
 set of generators \rightsquigarrow
 $\text{Spec} \mathbf{Z} \rightarrow \mathbf{P}^n$ s.t. composite
 $\text{Spec} \mathbf{Q} \rightarrow \text{Spec} \mathbf{Z} \rightarrow \mathbf{P}^n$ equals x
 $\rightsquigarrow \mathbf{P}^n(\mathbf{Q}) = \mathbf{P}^n(\mathbf{Z})$.

$$g := \gcd(a_0, a_1, \dots, a_n), L = \mathbf{Z}g \Rightarrow$$

$$x = (b_0 : b_1 : \dots : b_n), b_i := a_i/g,$$

$$b_i \in \mathbf{Z}, \gcd(b_0, \dots, b_n) = 1 \rightsquigarrow$$

$$\text{Spec} \mathbf{Z} =$$

$$\{(a_0, \dots, a_n) \in \mathbf{Z}^{n+1} \mid$$

$$\gcd(a_0, \dots, a_n) = 1\} / \{\pm 1\}$$

Examples, cont'd

- $X = \text{Spec} R$, R Dedekind ring,
 $K := \text{Frac} R$
 $x = (a_0 : a_1 : \dots : a_n) \in \mathbf{P}^n(K)$
 $a_i \in L := Ra_0 + \dots + Ra_n$
 set of generators \rightsquigarrow
 $\text{Spec} R \rightarrow \mathbf{P}^n$
NB: L may *not* be a trivial line bundle,
 e.g.,
 $R = \mathbf{Z}[\sqrt{-5}]$, $x = (2 : 1 + \sqrt{-5})$
- $X = \mathbf{P}^m \times \mathbf{P}^n$, $\mathcal{L}_1 := \pi_1^* \mathcal{O}_{\mathbf{P}^m}(1)$,
 $\mathcal{L}_2 := \pi_2^* \mathcal{O}_{\mathbf{P}^n}(1)$, $\mathcal{L} := \mathcal{L}_1 \otimes \mathcal{L}_2$,
 $x_{ij} := \pi_1^* x_i \otimes \pi_2^* x_j$,
 $((x_0 : x_1 : \dots : x_m), (y_0 : y_1 : \dots : y_n)) \mapsto$
 $(x_0 y_0 : \dots : x_0 y_n : \dots : x_m y_n)$
 This, the *Segre embedding*,
 identifies $\mathbf{P}^m \times \mathbf{P}^n$ with a
 closed subscheme of \mathbf{P}^{mn+m+n} .

Sixth lecture

Definition 0.13 *i) A module over a commutative ring is projective if it is a direct factor of a free module.*

ii) A quasi-coherent sheaf (M, ρ) with respect to gluing data $(\text{Spec } R, \text{Spec } S, s, t)$ on a scheme X is a vector bundle or a locally free sheaf if M is a finitely generated projective R -module.

Examples:

- Line bundles are vector bundles.
- Direct sums of vector bundles are vector bundles.
- More generally, extensions of vector bundles are vector bundles.
- $\Omega_{\mathbb{P}^n/K}^1$ is a vector bundle: Its restriction to an affine patch is $\Omega_{\mathbb{A}^n/K}^1$ and $\Omega_{K[x_1, \dots, x_n]/K}^1$ has dx_1, dx_2, \dots, dx_n as basis.

- The tensor product of vector bundles is a vector bundle.
- M R -module, $\Lambda^n M := M^{\otimes n} / \{a_1 \otimes \cdots \otimes a_i \otimes a_i \otimes \cdots \otimes a_{n-1}\}$,
exterior power
 \mathcal{E} vector bundle $\Rightarrow \Lambda^n \mathcal{E}$ v.b.
- *Symmetric powers* of vector bundles are vector bundles.

The projective line

Finitely generated modules over PID R :
Exact sequence

$$R^m \xrightarrow{A} R^n \rightarrow M \rightarrow 0$$

$m \times n$ -matrix A

Elementary row and column operations \rightsquigarrow

$$A = NDM, M \in \mathrm{SL}_m(R), N \in \mathrm{SL}_n(R),$$

D diagonal \rightsquigarrow

M is a sum of cyclic modules (i.e.,
 $\cong R/(f)$)

Torsion free \Rightarrow all f 's zero $\Rightarrow M$ free.

\mathcal{M} vector bundle over $\mathbf{P}^1 \leftrightarrow$

M_1 projective $K[x]$ -module,

M_2 projective $K[x^{-1}]$ -module,

$$\rho: M_1[x^{-1}] \cong M_2[x].$$

$$M_1 \cong K[x]^n, M_2 \cong K[x^{-1}]^n$$

$$\rho = R \in \mathrm{GL}_n(K[x, x^{-1}])$$

$$R \sim NRM, M \in \mathrm{GL}_n(K[x]), N \in \mathrm{GL}_n(K[x^{-1}])$$

Elementary row ($/K[x^{-1}]$) and
column ($/K[x]$) ops \rightsquigarrow :

$$R = NDM, M \in \mathrm{GL}_n(K[x]),$$

$$N \in \mathrm{GL}_n(K[x^{-1}]),$$

$$D \text{ diagonal w. entries } x^{k_i} \Rightarrow \mathcal{M} \cong \bigoplus_i \mathcal{O}_{\mathbf{P}^1}(k_i),$$

$$k_1 \leq k_2 \leq \dots \leq k_n$$

The k_i determined:

$$\mathcal{M} \otimes \mathcal{O}(m) \cong \bigoplus_i \mathcal{O}_{\mathbf{P}^1}(m + k_i)$$

$$\dim \Gamma(\mathbf{P}^1, \mathcal{M} \otimes \mathcal{O}(m)) = \sum_{m+k_i \geq 0} m + k_i$$

Remark: Krull-Schmidt also
does the trick

$$x, y \in \Gamma(\mathbf{P}^1, \mathcal{O}(1)) \rightsquigarrow$$

$$0 \rightarrow \mathcal{L} \longrightarrow \mathcal{O} \oplus \mathcal{O} \longrightarrow \mathcal{O}(1) \rightarrow 0$$

$$\mathcal{L} \cong ?$$

$$\text{rk } \mathcal{E}, \det \mathcal{E} := \wedge^{\text{rk } \mathcal{E}} \mathcal{E},$$

$$0 \rightarrow \mathcal{E} \longrightarrow \mathcal{F} \longrightarrow \mathcal{G} \rightarrow 0 \Rightarrow$$

$$\det \mathcal{F} \cong \det \mathcal{E} \otimes \det \mathcal{G} \Rightarrow$$

$$\mathcal{O}_{\mathbf{P}^1} \cong \mathcal{L} \otimes \mathcal{O}_{\mathbf{P}^1}(1) \Rightarrow \mathcal{L} \cong \mathcal{O}(-1)$$

$q_1, q_2, q_3 \in \Gamma(\mathbf{P}^1, \mathcal{O}(2))$ generating $\mathcal{O}(2)$:

$$0 \rightarrow \mathcal{E} \longrightarrow \mathcal{O}^3 \longrightarrow \mathcal{O}(2) \rightarrow 0$$

$$\mathcal{E} \cong \mathcal{O}(k_1) \oplus \mathcal{O}(k_2) \Rightarrow k_1 + k_2 = -2$$

$$0 \rightarrow \Gamma(\mathbf{P}^1, \mathcal{E}) \rightarrow K^3 \xrightarrow{(q_1, q_2, q_3)} K[x, y]_2$$

$$(q_1, q_2, q_3) = (x^2, xy, y^2) \Rightarrow$$

$$\Gamma(\mathbf{P}^1, \mathcal{E}) = 0 \Rightarrow$$

$$k_1, k_2 < 0 \Rightarrow k_1 = k_2 = -1$$

$$(q_1, q_2, q_3) = (x^2, 0, y^2) \Rightarrow$$

$$\Gamma(\mathbf{P}^1, \mathcal{E}) = K \Rightarrow (k_1, k_2) = (-2, 0)$$

The Kähler differentials

$$R = K[x_0, \dots, x_n]$$

$$\partial/\partial x_i: \Omega_{R/K}^1 \rightarrow K(-1), df \mapsto \partial f/\partial x_i \rightsquigarrow$$

$$\Omega_{R/K}^1 \cong R(-1)^{n+1}$$

$$\text{Proj} \rightsquigarrow \Omega_{\mathbf{P}^n/K}^1 \rightarrow \mathcal{O}(-1)^{n+1}$$

Euler's theorem: $Ef := \sum_i x_i \partial f/\partial x_i = \deg f \cdot f \Rightarrow f \in K(x_0, \dots, x_n)_0 \Rightarrow Ef = 0 \rightsquigarrow$

Complex:

$$0 \rightarrow \Omega_{\mathbf{P}^1/K}^1 \rightarrow \mathcal{O}_{\mathbf{P}^n}(-1)^{n+1} \xrightarrow{(x_0, \dots, x_n)} \mathcal{O}_{\mathbf{P}^n} \rightarrow 0$$

An exact sequence.

$\Omega_{\mathbf{P}^1/K}^1$ indecomposable

Seventh lecture

Some definitions

- *Dedekind scheme*:
Gluing data $(\mathbf{Spec} R, \mathbf{Spec} S, s, t)$,
 R Dedekind
- *finite type K -scheme*:
Gluing data $(\mathbf{Spec} R, \mathbf{Spec} S, s, t)$,
 R finitely generated K -algebra
- *smooth curve*:
Dedekind K -scheme, finite type
- *projective K -scheme*:
 $X = \mathbf{Proj} R$
- *connected scheme*:
not a non-trivial disjoint union

Assume $K = \overline{K}$

C proj. smooth connected curve

Proposition 0.14

$\exists!$ grp hom $\deg: \text{Pic}(C) \rightarrow \mathbf{Z}$ s.t.

$\mathcal{L} \subseteq \mathcal{M} \Rightarrow \deg(\mathcal{M}) - \deg(\mathcal{L}) = \text{length } \mathcal{M}/\mathcal{L}$

Special case:

$s: \mathcal{O}_C \rightarrow \mathcal{L}$, $\text{length } \mathcal{M}/\mathcal{O} = \#$ of zeroes

$\deg(\mathcal{M}) - \deg(\mathcal{O}) = \deg(\mathcal{M})$

\mathcal{F} coherent sheaf $/C \Rightarrow h^0(\mathcal{F}) :=$

$\dim H^0(C, \mathcal{F}) < \infty$

Riemann's theorem:

$\exists g \geq 0: \mathcal{L} \in \text{Pic}(C) \Rightarrow$

$$h^0(\mathcal{L}) \geq \deg \mathcal{L} + 1 - g$$

$\Omega_{C/K}^1 \in \text{Pic}(C)$, $g = h^0(\Omega_{C/K}^1)$

Proposition 0.15

$$H^0(C, \mathcal{O}_C) = K$$

PROOF:

\mathcal{O}_C coherent \Rightarrow

$T = H^0(C, \mathcal{O}_C)$ fin. alg.

Non-trivial idemp.: C non-conn.

$T \subset R$, Dedekind \Rightarrow no nilp.

$$K = \overline{K} \Rightarrow T = K$$

□

Consequence:

$$\mathcal{L} \in \text{Pic}(C) \Rightarrow H^0(C, \mathcal{L}) = K$$

Curves of Genus 0

$g = 0$:

$$x \in C(K), \mathcal{O}(x) := m_x^{-1}, \sim$$

$$0 \rightarrow \mathcal{O}_C \xrightarrow{s} \mathcal{O}(x) \rightarrow \mathbf{k}_x \rightarrow 0 \Rightarrow$$

$$\text{deg: } (x) = 1 \Rightarrow$$

$$h^0(\mathcal{O}(x)) \geq 1 + 1 - 0 = 2 \Rightarrow$$

$$\exists t \in H^0(C, \mathcal{O}(x)): t_x \neq 0 \Rightarrow$$

$$s, t \text{ span } \mathcal{O}(x) \sim$$

$$C \rightarrow \mathbf{P}^1,$$

$$\text{deg } \mathcal{O}(x) = 1 \Rightarrow \text{is isom.}$$

Argument gives:

$$\exists \mathcal{L} \in \text{Pic}(C): h^0(\mathcal{L}) \geq 2 \Rightarrow C \cong \mathbf{P}^1$$

Elliptic curves

char $K \neq 2$

$E := \mathbf{Proj} K[x, y, z]/(y^2z - F(x, z))$
 $F(x, z) = z^3 f(x/z)$, f homog of deg 3,
 f no mult. roots

$z \neq 0$ patch: $y^2 = f(x)$

Complex case:

Going around ∞ permutes roots \rightsquigarrow

Torus w. 1 missing pt.

$z = 0$: $F(x, 0) = 0 \Rightarrow (0:1:0)$

Missing point!

Genus of elliptic curve

$$dx/y \in \Gamma(E, \Omega_{E/K}^1):$$

$$y^2 = f(x) \Rightarrow \boxed{2ydy = f'(x)dx}$$

- $z \neq 0$:
 - $y \neq 0$: $\boxed{dx/y}$,
Also $f'(x) \neq 0 \Rightarrow dx/y = 2dy/f'(x)$
 - $f'(x) \neq 0$: $\boxed{2dy/f'(x)}$
 - $y = 0, f'(x) = 0 \Rightarrow f(x) = 0 \Rightarrow$
 $\boxed{\text{Double root}}$

- $y \neq 0$: $(x':1:z') = (x'/z':1/z':1) \Rightarrow$
 $dx/y = (d(x'/z'))/(1/z') = dx' - x'/z' dz'$
 $g(x', z')z' = x'^3, g(0, 0) \neq 0 \Rightarrow$
 May assume $h = g^{-1}$ exists \Rightarrow
 $z' = gx'^3 \Rightarrow \frac{x'}{z'} dz' = x' h dg + 3dx'$

- $y = 0, z = 0 \Rightarrow 0 = F(x, 0) \Rightarrow x = 0$

$$dx/y \text{ generator} \Rightarrow \boxed{g = 1}$$

Picard group

$$\infty := (0:1:0),$$

$$x \in E(K): \mathcal{O}(x) := m_x^{-1}$$

$$\text{Pic}^0(E) := \ker \deg$$

Theorem 0.16 *The map*

$$\begin{array}{ccc} E(K) & \rightarrow & \text{Pic}^0(E) \\ x & \mapsto & \mathcal{O}(x) \otimes \mathcal{O}(\infty)^{-1} \end{array}$$

is a bijection.

PROOF:

Injectivity:

$$\mathcal{O}(x) \otimes \mathcal{O}(\infty)^{-1} \cong \mathcal{O}(y) \otimes \mathcal{O}(\infty)^{-1} \iff$$

$$\mathcal{O}(x) \cong \mathcal{O}(y):$$

$$s^x \in \Gamma(E, \mathcal{O}(x)), s^y \in \Gamma(E, \mathcal{O}(y))$$

$$g \neq 0 \Rightarrow h^0(\mathcal{O}(x)) \leq 1 \Rightarrow x = y$$

Surjectivity:

$$\mathcal{L} \in \text{Pic}^0(E) \Rightarrow$$

$$h^0(\mathcal{L} \otimes \mathcal{O}(\infty)) \geq 1 \Rightarrow$$

$$0 \rightarrow \mathcal{O}_E \rightarrow \mathcal{L} \otimes \mathcal{O}(\infty) \rightarrow x \rightarrow 0 \rightsquigarrow$$

$$\mathcal{L} \otimes \mathcal{O}(\infty) \cong \mathcal{O}(x)$$

□

Group structure

$$x, y \in E(K) \Rightarrow \exists! z \in E(K): \\ \mathcal{O}(x) \otimes \mathcal{O}(y) \cong \mathcal{O}(z) \otimes \mathcal{O}(\infty)$$

Which is it?

$$q \in \Gamma(\mathbf{P}^2, \mathcal{O}(n)):$$

Restriction $q: \mathcal{O}_E \rightarrow \mathcal{O}(n)|_E$ has zeroes x_1, \dots, x_m with multiplicity!

- $m = 3n$ (Bezout's theorem)
- $\mathcal{O}(n)|_E \cong \mathcal{O}_E(x_1) \otimes \cdots \otimes \mathcal{O}_E(x_m)$
Factorisation into prime ideals!

Consequence:

$$\mathcal{O}_E(x_1) \otimes \cdots \otimes \mathcal{O}_E(x_m) \text{ indep. of } q$$

$n = 1, q = z:$

$$z = 0 \wedge y^2 z = F(x, z) \Rightarrow (x:y:z) = \infty \Rightarrow$$

$$x_1 = x_2 = x_3 = \infty$$

General $\ell \in \Gamma(\mathbf{P}^2, \mathcal{O}(1)):$

Zeros x_1, x_2, x_3

$$\mathcal{O}_E(x_1) \otimes \mathcal{O}_E(x_2) \otimes \cdots \otimes \mathcal{O}_E(x_3) \cong$$

$$\mathcal{O}_E(\infty) \otimes \mathcal{O}_E(\infty) \otimes \cdots \otimes \mathcal{O}_E(\infty)$$

Symbolically: $x_1 + x_2 + x_3 \equiv 3\infty$

$$\ell = x - \lambda z \Rightarrow$$

$$(\lambda:\mu:1) + (\lambda:-\mu:1) + \infty \equiv 3\infty$$

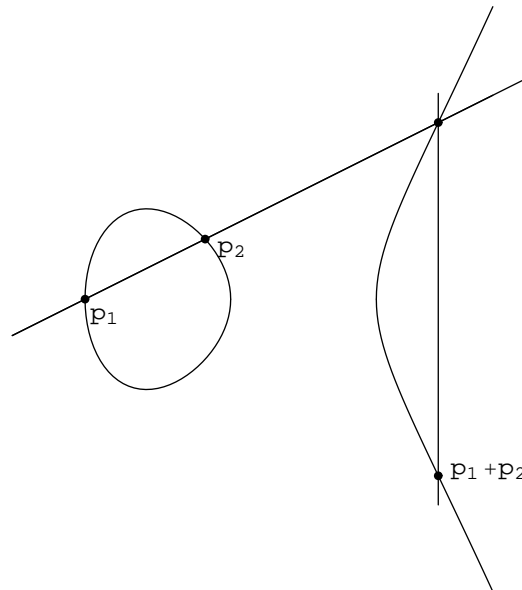

$$P_1 + P_2 + Q \equiv 3\infty \wedge$$

$$Q + (P_1 + P_2) + \infty \equiv 3\infty \Rightarrow$$

$$P_1 + P_2 \equiv (P_1 + P_2) + \infty$$

$$\infty \leftrightarrow 0: (P_1, P_2) \mapsto P_1 + P_2$$

Theorem 0.17 *There is a (unique) commutative group operation*

$$+ : E(K) \times E(K) \rightarrow E(K) \text{ s.t.}$$

$$\mathcal{O}(x) \otimes \mathcal{O}(y) \cong \mathcal{O}(x + y) \otimes \mathcal{O}(\infty)$$

$$(x_1 : y_1 : 1) + (x_1 : y_1 : 1) = (x_3 : y_3 : 1):$$

$$\begin{cases} y_3^2 = f(x_3) \\ y_3 = \frac{y_2 - y_1}{x_2 - x_1}(x_3 - x_1) + y_1 \end{cases} \quad k := \frac{y_2 - y_1}{x_2 - x_1}$$

$$k^2(x_3 - x_1)^2 = x_3^3 + bx_3^2 + cx_3 + d$$

$$x_1 + x_2 + x_3 = b - k^2 \Rightarrow$$

$$x_3 = b - k^2 - x_1 - x_2,$$

$$y_3 = k(x_3 - x_1) + y_1 \rightsquigarrow$$

Algebraic group scheme:

$$\boxed{+ : E \times E \rightarrow E}$$

Remark:

i) Associativity non-obvious!

Clear from previous results

ii) *Projective* group scheme

Putting things together

$f(x) \in \mathbf{Z}[x]$:

E \mathbf{Z} -scheme (=scheme) $\mathbf{P}^2(\mathbf{Q}) = \mathbf{P}^2(\mathbf{Z}) \Rightarrow$

$E(\mathbf{Q}) = E(\mathbf{Z})$

$\mathbf{Z} \rightarrow \mathbf{Z}/\mathbf{Z}_p \rightsquigarrow E(\mathbf{Q}) \rightarrow E(\mathbf{Z}/\mathbf{Z}_p)$

$f(x) = x^3 + 4x - 1$

$(1/8 : 1/4 : 1) \in E(\mathbf{Q}) :$

$(1/8)^2 = (1/4)^3 + 4 \cdot 1/4 - 1 = 0$

$(1 : 2 : 8) \in E(\mathbf{Z}) \rightsquigarrow$

$(1 : -1 : -1) = (-1 : 1 : 1) \in E(\mathbf{Z}/\mathbf{Z}_5)$

$E(\mathbf{Q}) \rightarrow E(\mathbf{Z}/\mathbf{Z}_p)$ group homomorphism:

Lines reduce to lines or

$f: X \rightarrow Y \Rightarrow \mathcal{L} \rightsquigarrow f^* \mathcal{L}$

$f^*(\mathcal{L} \otimes \mathcal{M}) = f^* \mathcal{L} \otimes f^* \mathcal{M}$

Classification for $g = 1$

$g(C) = 1$:

Pick $p \in C(K), 0 \neq z \in \Gamma(C, \mathcal{O}(p)),$

$x^2 := x \otimes x \in \Gamma(C, \mathcal{O}(2p)),$

$\mathcal{O}(2p) := \mathcal{O}(p) \otimes \mathcal{O}(p)$

Riemann: $h^0(\mathcal{O}(2p)) \geq 2 + 1 - 1 = 2 \Rightarrow$

$x \in \Gamma(C, \mathcal{O}(2p)), x^2$ and y lin. indep.

$x_p \neq 0$:

$x_p = 0 \Rightarrow x = zt, t \in \Gamma(C, \mathcal{O}(p)),$

$\Gamma(C, \mathcal{O}(p)) = Kx$ as $\deg \mathcal{O}(p) = 1 \Rightarrow$

$h^0(\mathcal{O}(p)) \leq 1 \Rightarrow x \in Kzt = Kz^2$

Conclusion: x and z^2 generate $\mathcal{O}(2p)$.

$h^0(\mathcal{O}(3p)) \geq 3 + 1 - 1 = 3 \Rightarrow$

$y \in \Gamma(C, \mathcal{O}(3p)), y \notin Kxz + Kz^3$

$y^2, yxz, yz^3, x^3, x^2z^2, xz^4, z^6 \in \Gamma(C, \mathcal{O}(6p))$

Classification, cont'd

Riemann-Roch

$$\Rightarrow h^0(\mathcal{O}(6p)) = 6 + 1 - 1 = 6 \Rightarrow$$

$$y^2, yxz, yz^2, x^3, x^2z, xz, z^3$$

linearly dependent: \rightsquigarrow

$$y^2 + a_1 yxz + a_3 yz^3 =$$

$$x^3 + a_2 x^2z + a_4 xz^4 + a_6 z^6$$

x, y not determined.

$$\begin{cases} y \mapsto uy + rxz + sz^3 \\ x \mapsto vx + tz^2 \end{cases}$$

$\text{char } K \neq 2 \Rightarrow$

$$y^2 = x^3 + a_2 x^2z + a_4 xz^4 + a_6 z^6$$

Homogeneous if

$$\deg x = 2, \deg y = 3, \deg z = 1.$$

weighted projective space!

$$z \neq 0: (x:y:1) \Rightarrow y^2 = f(x)$$

$$z = 0: y^2 = x^3 \rightsquigarrow (1:1:0)$$

Conclusion: Completes by one point.

Highlights

- Over \mathbb{C} torus, $E = \mathbb{C}/\mathbb{Z}\omega_1 + \mathbb{Z}\omega_2$.

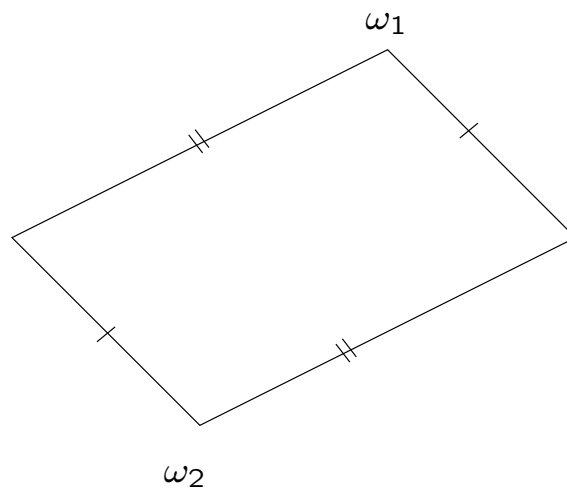

- Construct interesting *non-commutative* algebras (*Sklyanin algebras*).
- $f(x) \in \mathbb{Q}[x]$, $E(\mathbb{Q})$ finitely generated group.
- $f(x) \in \mathbb{F}_q$, $|\mathbb{F}_q| = q$, $|\#E(\mathbb{F}_q) - q - 1| \leq 2\sqrt{q}$.

- Ramanujam's conjecture:
 $q \prod_i (1 - q^n)^{24} = \sum_n \tau(n) q^n \Rightarrow$
 $|\tau(n)| \leq \sigma_0(n) n^{11/2}$
 $\sigma_0(n) = \sum_{d|n} 1$
- String theory
- “Monstrous moonshine”
- Arithmetic of torsion points:
 $\{x \in E(\overline{\mathbf{Q}}) \mid nx = 0\}$
- Elliptic curve cryptography

Eighth lecture

Vector bundles on curves

C smooth, proper, connected curve

$\mathcal{F} \subseteq \mathcal{E}$ two vector bundles on C .

\mathcal{F} is a *subbundle* if

\mathcal{E}/\mathcal{F} is a vector bundle.

$\mathcal{F} \subseteq \mathcal{E}$ subbundle \iff

$\mathcal{F} \subseteq \mathcal{F}' \subseteq \mathcal{E} \wedge \text{rk } \mathcal{F} = \text{rk } \mathcal{F}' \Rightarrow \mathcal{F} = \mathcal{F}'$

$\mathcal{L} \subset \mathcal{M}$, line bundles,

\mathcal{L} subbundle $\iff \mathcal{L} = \mathcal{M}$.

\mathcal{E} vector bundle, *slope*,

$s(\mathcal{E}) := \text{deg } \mathcal{E} / \text{rk } \mathcal{E}$, $\text{deg } \mathcal{E} := \text{deg det } \mathcal{E}$

Definition 0.18 *A vector bundle \mathcal{E} on C is stable resp. semi-stable if for every subsheaf $\mathcal{F} \subset \mathcal{E}$ we have $s(\mathcal{F}) < s(\mathcal{E})$ resp. $s(\mathcal{F}) \leq s(\mathcal{E})$.*

$\mathcal{S}_s :=$ category of semi-stable vector bundles of fixed slope s .

Lemma 0.19 $b, d > 0, \frac{a}{b} \leq \frac{c}{d} \Rightarrow$
 $\frac{a}{b} \leq \frac{a+c}{b+d} \leq \frac{c}{d}$

Consequence:

$0 \rightarrow \mathcal{E} \rightarrow \mathcal{F} \rightarrow \mathcal{G} \rightarrow 0$ exact \Rightarrow
 $\deg \mathcal{F} = \deg \mathcal{E} + \deg \mathcal{G}, \text{rk } \mathcal{F} = \text{rk } \mathcal{E} + \text{rk } \mathcal{G} \Rightarrow$
 $t := \max(s(\mathcal{E}), s(\mathcal{G})), r := \min(s(\mathcal{E}), s(\mathcal{G}))$
 $\Rightarrow \boxed{r \leq s(\mathcal{F}) \leq t}$

Big surprise:

Proposition 0.20 \mathcal{S}_s is an abelian subcategory of the category of quasi-coherent sheaves. Every object has finite length and the simple objects are the stable sheaves.

Proof:

Let $f: \mathcal{E} \rightarrow \mathcal{F}, \mathcal{E}, \mathcal{F} \in \mathcal{S}_s$
 $\mathcal{G} := \ker f, \mathcal{H} := \text{Im } f,$
 Semistability of $\mathcal{E} \Rightarrow$
 $s(\mathcal{G}) \leq s(\mathcal{E}) \Rightarrow s(\mathcal{H}) \geq s(\mathcal{E}) = s$
 Semistability of $\mathcal{F} \Rightarrow$
 $s(\mathcal{H}) \leq s(\mathcal{F}) = s$
 Together: $s(\mathcal{G}) = s = s(\mathcal{H})$

Proof, cont'd

$$s(\ker f) = s(\operatorname{Im} f) = s(\operatorname{coker} f) = s$$

Assume

$$\mathcal{E}, \mathcal{F} \in \mathcal{S}_s, \mathcal{E} \hookrightarrow \mathcal{F}, \operatorname{rk} \mathcal{E} = m = \operatorname{rk} \mathcal{F}$$

$$\Rightarrow \deg \mathcal{E} = ms = \deg \mathcal{F}$$

$$\mathcal{E} \rightarrow \mathcal{F} \text{ iso} \iff \Lambda^m \mathcal{E} \rightarrow \Lambda^m \mathcal{F} \text{ iso}$$

$$\iff (\det(A) \text{ invert.} \iff A \text{ invert.})$$

$$\mathcal{E} \hookrightarrow \mathcal{F} \Rightarrow \det \mathcal{E} \hookrightarrow \det \mathcal{F}$$

$$0 = \deg \det \mathcal{E} - \deg \det \mathcal{F} = \operatorname{length} \det \mathcal{F} / \det \mathcal{E} \Rightarrow$$

$$\mathcal{E} \hookrightarrow \mathcal{F} \text{ iso}$$

$$\text{Conclusion: } \mathcal{E}, \mathcal{F} \in \mathcal{S}_s, \mathcal{E} \not\subseteq \mathcal{F}$$

$$\Rightarrow \operatorname{rk} \mathcal{E} < \operatorname{rk} \mathcal{F} \Rightarrow \text{finite length.}$$

Clear: Stable \iff simple

The Harder-Narasimhan filtration

\mathcal{E} vector bundle on C

$$s_{max}(\mathcal{E}) = s := \max \{s(\mathcal{F}) \mid \mathcal{F} \subseteq \mathcal{E}\}$$

s exists:

Riemann's theorem for vector bundles:

$$h^0(\mathcal{G}) \geq \deg \mathcal{G} + \text{rk } \mathcal{G}(1 - g)$$

$s(\mathcal{F})$ unbounded $\Rightarrow h^0(\mathcal{G})$ unbounded but

$$h^0(\mathcal{F}) \leq h^0(\mathcal{E}) < \infty$$

Let $\mathcal{F} \subseteq \mathcal{E}$, $s(\mathcal{F}) = s$, maximal rank

Assume $\mathcal{G} \subseteq \mathcal{E}$, $s(\mathcal{G}) = s$

$$0 \rightarrow \mathcal{G} \cap \mathcal{F} \rightarrow \mathcal{G} \rightarrow \mathcal{G}/\mathcal{G} \cap \mathcal{F} \rightarrow 0$$

$$s(\mathcal{G} \cap \mathcal{F}) \leq s \Rightarrow s(\mathcal{G}/\mathcal{G} \cap \mathcal{F}) \geq s$$

$$\mathcal{G}/\mathcal{G} \cap \mathcal{F} = \mathcal{G} + \mathcal{F}/\mathcal{F} \Rightarrow s(\mathcal{G} + \mathcal{F}) \geq s \Rightarrow$$

$$\text{rk } \mathcal{G} + \mathcal{F} = \text{rk } \mathcal{F} \Rightarrow \det \mathcal{F} \hookrightarrow \det(\mathcal{G} + \mathcal{F})$$

$$\deg \mathcal{F} = \deg(\mathcal{G} + \mathcal{F}) \Rightarrow \mathcal{F} = \mathcal{G} + \mathcal{F} \Rightarrow \mathcal{G} \subseteq \mathcal{F}$$

Conclusion

$\mathcal{E}_s := \mathcal{F}$ largest subsheaf with slope s .

- \mathcal{E}_s subbundle: If not
 $\mathcal{E}_s \subsetneq \mathcal{F} \subseteq \mathcal{E}, \text{rk } \mathcal{E}_s = \text{rk } \mathcal{F} \Rightarrow$
 $s(\mathcal{F}) > s(\mathcal{E}_s)$
- $s_{\max}(\mathcal{E}/\mathcal{E}_s) < s$: If not
 $\mathcal{E}_s \subsetneq \mathcal{F} \subseteq \mathcal{E}, s(\mathcal{F}/\mathcal{E}_s) \geq s \Rightarrow s(\mathcal{F}) \geq s$.
- \mathcal{E}_s semi-stable: If not,
 $0 \neq \mathcal{F} \subsetneq \mathcal{E}_s, s(\mathcal{F}) > s$

Repeating:

Proposition 0.21 \mathcal{E} vector bundle / C

Unique filtration by subbundles:

$$0 \subsetneq \mathcal{E}_1 \subsetneq \mathcal{E}_2 \subsetneq \dots \subsetneq \mathcal{E}_n = \mathcal{E}$$

$$s(\mathcal{E}_1) > s(\mathcal{E}_2/\mathcal{E}_1) > \dots > s(\mathcal{E}/\mathcal{E}_{n-1})$$

$\mathcal{E}_i/\mathcal{E}_{i-1}$ semi-stable

The projective line

$\mathcal{L} \in \text{Pic}(C)$: \mathcal{E} (semi-)stable $\iff \mathcal{E} \otimes \mathcal{L}$

$(-)\otimes\mathcal{L}$ exact with inverse $(-)\otimes\mathcal{L}^{-1}$

$\det(\mathcal{E} \otimes \mathcal{L}) = \det \mathcal{E} \otimes \mathcal{L}^{\otimes \text{rk } \mathcal{E}} \Rightarrow$

$s(\mathcal{E} \otimes \mathcal{L}) = s(\mathcal{E}) + \deg \mathcal{L}$

Riemann:

$$\frac{h^0(\mathcal{E})}{\text{rk } \mathcal{E}} \geq s(\mathcal{E}) + 1 - g$$

$C = \mathbf{P}^1$, \mathcal{E} stable:

$\mathcal{E} \leftrightarrow \mathcal{E}(m)$: $-1 < s(\mathcal{E}) \leq 0$

$h^0(\mathcal{E}) / \text{rk } \mathcal{E} > -1 + 1 - 0 = 0 \Rightarrow$

$\mathcal{O}_{\mathbf{P}^1} \subseteq \mathcal{E}$, $s(\mathcal{O}) = 0 = s(\mathcal{E}) \Rightarrow \mathcal{E} = \mathcal{O}$

Semi-stable:

$\mathcal{E} = \mathcal{O}^n$ induction over rank

$\mathcal{F} \subseteq \mathcal{E}$, \mathcal{F} stable of slope 0.

$\mathcal{E}/\mathcal{F} \cong \mathcal{O}^{n-1}$

General facts:

$0 \rightarrow \mathcal{E} \rightarrow \mathcal{F} \rightarrow \mathcal{G} \rightarrow 0 \leftrightarrow \alpha \in \text{Ext}^1(\mathcal{G}, \mathcal{E})$

$\mathcal{F} \cong \mathcal{E} \oplus \mathcal{G} \leftrightarrow 0$

$\text{Ext}^1(\mathcal{G} \oplus \mathcal{G}', \mathcal{E}) = \text{Ext}^1(\mathcal{G}, \mathcal{E}) \oplus \text{Ext}^1(\mathcal{G}', \mathcal{E})$

Cont'd

Quasi-coherent sheaves on C :

$\mathcal{L}, \mathcal{M} \in \text{Pic}(C)$,

$$\dim_K \text{Ext}_{\mathcal{O}_C}(\mathcal{L}, \mathcal{M}) = h^0(\mathcal{L} \otimes \mathcal{M}^{-1} \otimes \Omega_{C/K}^1)$$

$$\dim_K \text{Ext}_{\mathcal{O}_{\mathbb{P}^1}}(\mathcal{O}, \mathcal{O}) =$$

$$h^0(\Omega_{\mathbb{P}^1/K}^1) = h^0(\mathcal{O}(-2)) = 0 \rightsquigarrow$$

$$\mathcal{E} \cong \mathcal{O}^n \Rightarrow \mathcal{E} \text{ semi-stable } \mathcal{E} \cong \mathcal{O}(m)^n, m = s(\mathcal{E})$$

\mathcal{E} general:

$$\mathcal{E}_i / \mathcal{E}_{i-1} \cong \mathcal{O}(s_i)^{n_i}, s_1 < s_2 < \dots < s_n$$

$$s < t \Rightarrow \dim \text{Ext}_{\mathcal{O}_{\mathbb{P}^1}}(\mathcal{O}(t), \mathcal{O}(s)) =$$

$$h^0(\mathcal{O}(-2 + s - t)) = 0$$

Remark:

$$0 \rightarrow \mathcal{O}(-1) \rightarrow \mathcal{O}^2 \rightarrow \mathcal{O}(1) \rightarrow 0$$

non-split

Elliptic curves

E elliptic curve, \mathcal{E} stable vector bundle

$\mathcal{E} \leftrightarrow \mathcal{E} \otimes \mathcal{L}$: May assume

$$\deg \mathcal{L} = 0 \Rightarrow h^0(\mathcal{E} \otimes \mathcal{L}) = 0$$

$$\exists \mathcal{M} \in \text{Pic}(E): \deg \mathcal{L} \wedge h^0(\mathcal{E} \otimes \mathcal{M}) > 0$$

$$\text{Riemann: } 0 = \frac{h^0(\mathcal{E})}{\text{rk } \mathcal{E}} \geq s(\mathcal{E}) + 1 - 1 \Rightarrow$$

$$s(\mathcal{E}) \leq 0$$

$$\mathcal{O} \rightarrow \mathcal{E} \otimes \mathcal{M} \leftrightarrow \mathcal{M}^{-1} \rightarrow \mathcal{E} \Rightarrow$$

$$-1 = s(\mathcal{M}^{-1}) < s(\mathcal{E})$$

Assume $\text{rk } \mathcal{E} = 2$: \Rightarrow

$$s(\mathcal{E}) = -1/2 \vee s(\mathcal{E}) = 0$$

$$s(\mathcal{E}) = -1/2:$$

$\mathcal{M}^{-1} \subset \mathcal{E}$ subbundle,

if not $\mathcal{M}^{-1} \not\subseteq \mathcal{L} \subset \mathcal{E} \Rightarrow$

$$s(\mathcal{L}) > s(\mathcal{M}^{-1}) = -1$$

Cont'd $s(\mathcal{E}) = -1/2$

$$\mathcal{M} \cong \mathcal{O}(x), x \in E(K), \mathcal{O}(-x) := \mathcal{O}(x)^{-1}$$

$$0 \rightarrow \mathcal{O}(-x) \rightarrow \mathcal{E} \rightarrow \mathcal{L} \rightarrow 0$$

$$\begin{aligned} -1 = \deg \mathcal{E} &= -1 + \deg \mathcal{L} \Rightarrow \\ \deg \mathcal{L} &= 0 \end{aligned}$$

$$0 \rightarrow \mathcal{O}(-x) \rightarrow \mathcal{E} \rightarrow \mathcal{L} \rightarrow 0$$

Non-split!

Conversely, $\text{Pic}(E) \ni \mathcal{M} \subset \mathcal{E}, \deg \mathcal{M} \geq 0$
 $\mathcal{M} \rightarrow \mathcal{E} \rightarrow \mathcal{L}, \text{ non-zero} \Rightarrow \text{iso} \Rightarrow \text{split} \Rightarrow$
 $\mathcal{M} \rightarrow \mathcal{O}(-x), \text{ non-zero} \Rightarrow$
 $-1 = \deg \mathcal{O}(-x) \geq \deg \mathcal{M} \geq 0$

Exists? $\dim \text{Ext}_{\mathcal{O}_E}(\mathcal{L}, \mathcal{O}(-x)) =$
 $h^0(\mathcal{O}(x) \otimes \mathcal{L} \otimes \Omega_{E/K}^1) = h^0(\mathcal{O}(x) \otimes \mathcal{L})$
 $\deg \mathcal{O}(x) \otimes \mathcal{L} = 1 \Rightarrow h^0(\mathcal{O}(x) \otimes \mathcal{L}) = 1$
 $\det \mathcal{E} = \mathcal{O}(-x) \otimes \mathcal{L} \cong \mathcal{O}(-y),$

Depends only on $y \Rightarrow$

parameter $y \in E(K)$

$s(\mathcal{E}) = 0$:

Example:

$$\dim \text{Ext}_{\mathcal{O}_E}(\mathcal{O}_E, \mathcal{O}_E) = h^0(\Omega_{E/K}^1) = 1 \Rightarrow$$

Non-split:

$$0 \rightarrow \mathcal{O}_E \longrightarrow \mathcal{F} \longrightarrow \mathcal{O}_E \rightarrow 0$$

Semi-stable

Stable \mathcal{E} :

$\mathcal{O}(-x) \hookrightarrow \mathcal{E}$, subbundle \Rightarrow

$$0 \rightarrow \mathcal{O}(-x) \longrightarrow \mathcal{E} \longrightarrow \mathcal{O}(y) \rightarrow 0$$

$\leadsto \exists \mathcal{L} \in \text{Pic}(E): \mathcal{E} \cong \mathcal{F} \otimes \mathcal{L}$,

only semi-stable

Conclusion: Semi-stable bundles

Slope	Form
0	$\mathcal{O}(x - \infty) \oplus \mathcal{O}(y - \infty)$
0	$\mathcal{E}/\mathcal{O}(x - \infty) \cong \mathcal{O}(-x + \infty)$
$-1/2$	$\mathcal{E}/\mathcal{O}(-\infty) \cong \mathcal{O}(\infty - x)$

$$\mathcal{O}(\infty - x) := \mathcal{O}(\infty) \otimes \mathcal{O}(x)^{-1}$$

General curves

C smooth proper connected curve

\mathcal{E} semi-stable, $n := \text{rk } \mathcal{E}$, $d := \text{deg } \mathcal{E}$

Action $\text{Pic}(C)$: $\mathcal{E} \mapsto \mathcal{E} \otimes \mathcal{L} \sim$

$0 \leq s(\mathcal{E}) < n$, $\det \mathcal{E}$ fixed

$\text{gcd}(d, n) = 1 \Rightarrow \mathcal{E}$ stable

Results for stable bundles:

- $g = 1$, $(n, d) = (2, -1)$:
 $\det \mathcal{E}$ fixed $\Rightarrow \mathcal{E}$ unique (up to iso)
- $g = 1$: Generally \mathcal{E} exists $\iff \text{gcd}(d, n)$
and then it is unique.
- $g > 1$: \mathcal{E} exists for all (d, n) .
“Smooth parameter scheme” of
dimension $(n^2 - 1)(g - 1)$
- $d = 0$: Over \mathbb{C} $\mathcal{E} \leftrightarrow$ irreducible
representations of the *fundamental*
group of C in SU_n up to conjugation