



The Abdus Salam
International Centre for Theoretical Physics



SMR: 1643/7

*WINTER COLLEGE ON OPTICS ON OPTICS AND PHOTONICS
IN NANOSCIENCE AND NANOTECHNOLOGY*

(7 - 18 February 2005)

"Biophotonics at the Nanoscale" - 1

presented by:

L. Novotny
The Institute of Optics
Rochester
U.S.A.

These are preliminary lecture notes, intended only for distribution to participants.

NANOBIOPHOTONICS

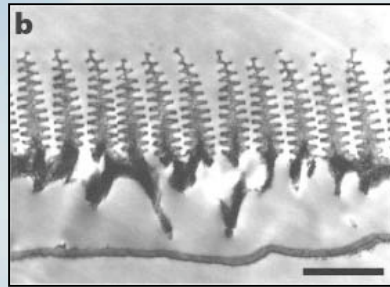

Lukas Novotny

The Institute of Optics, University of Rochester, Rochester, NY, 14627.

.. application of optical science and technology to
the study of nanoscale biological processes.

Basic Sciences . . . Optics . . . Technical Sciences

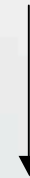

Nanoscience . . . **NANO-OPTICS** . . . Nanotechnology

Nano-Optics is the study of optical phenomena and techniques near or beyond the diffraction limit.

NANO-OPTICS @ ROCHESTER



www.nano-optics.org

OPTICS - BIOMEDICAL ENGINEERING BUILDING PROJECT



PROTEINS WORKING IN SYNCHRONY

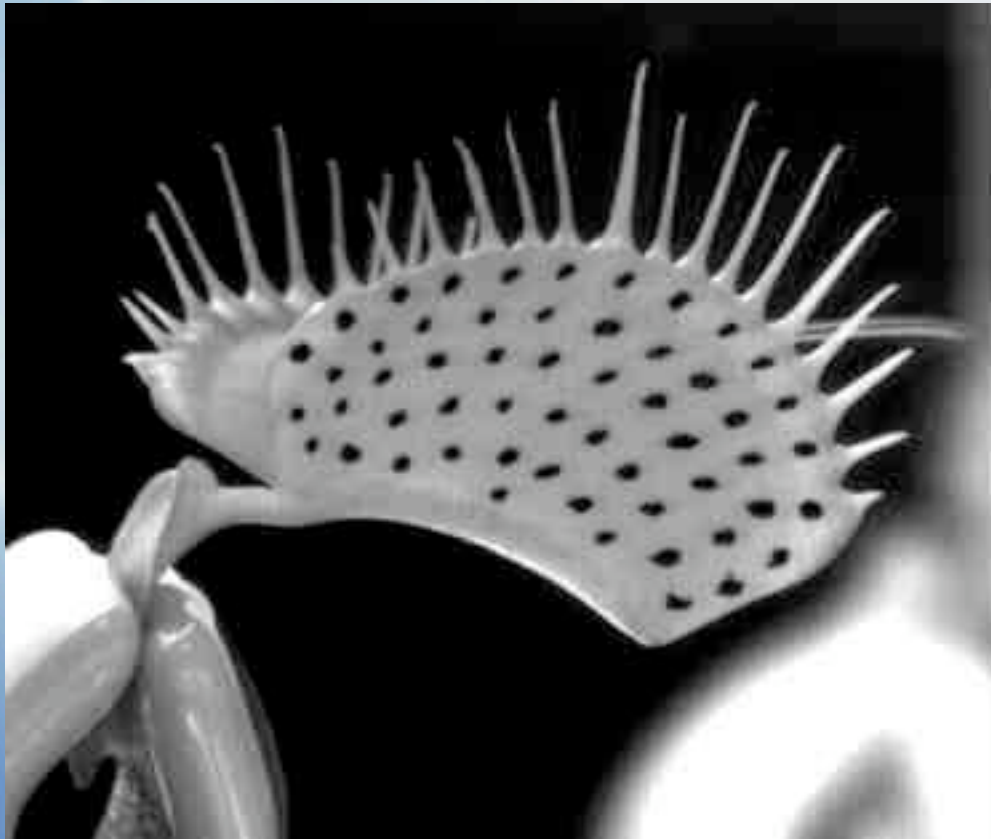

Cell signaling and coordination are true marvels of nature !

BIOLOGICAL BUILDING BLOCKS

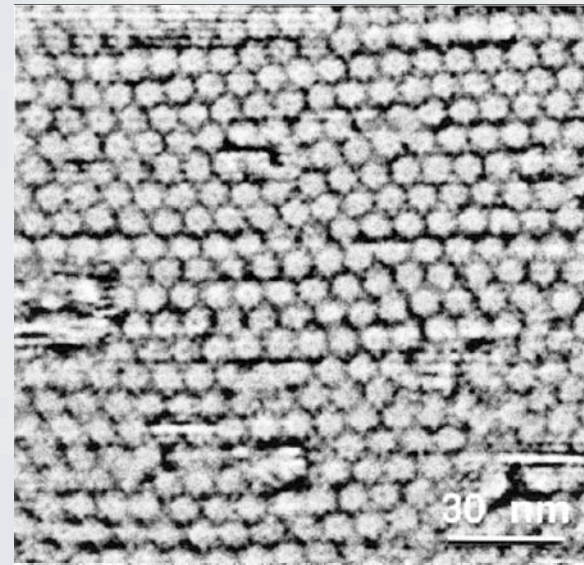
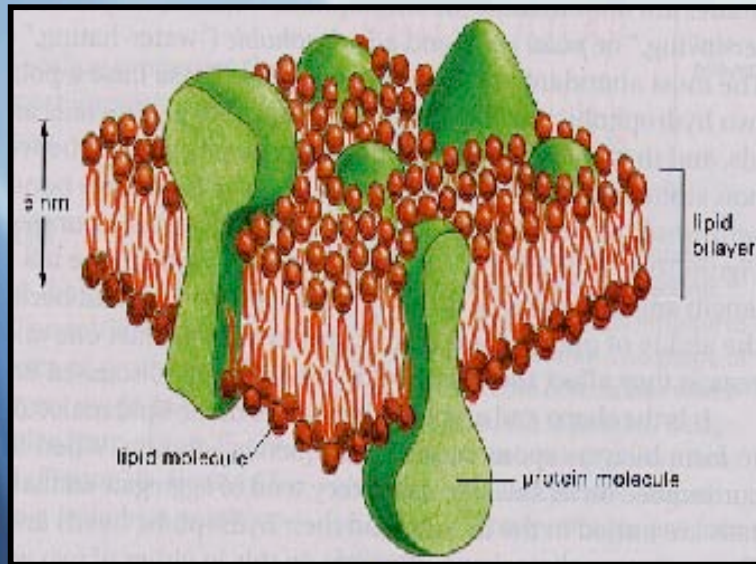

Biology functions through highly coordinated and complex interactions among nanostructures. Biology is Nanobiotechnology !

STRUCTURE OF NANOBIOPHOTONICS

BIOLOGY

PHOTONICS

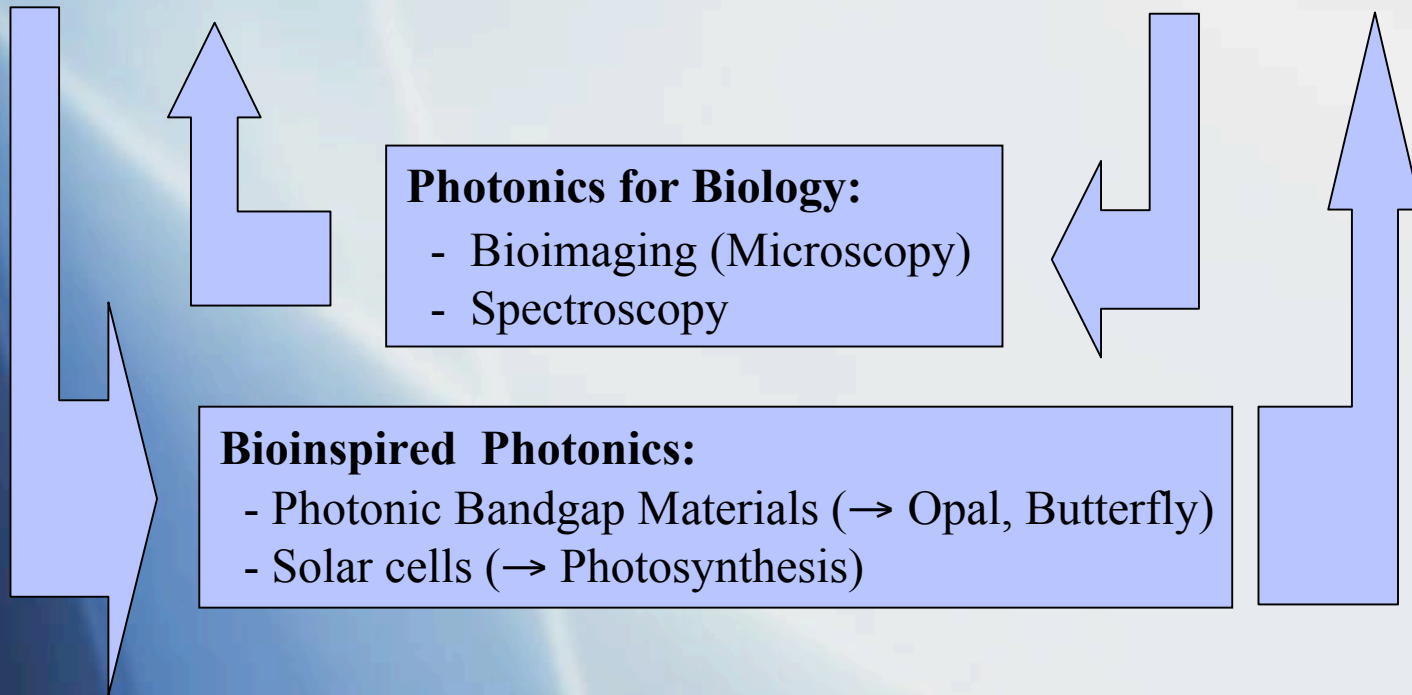

THE BIOTECH CYCLE

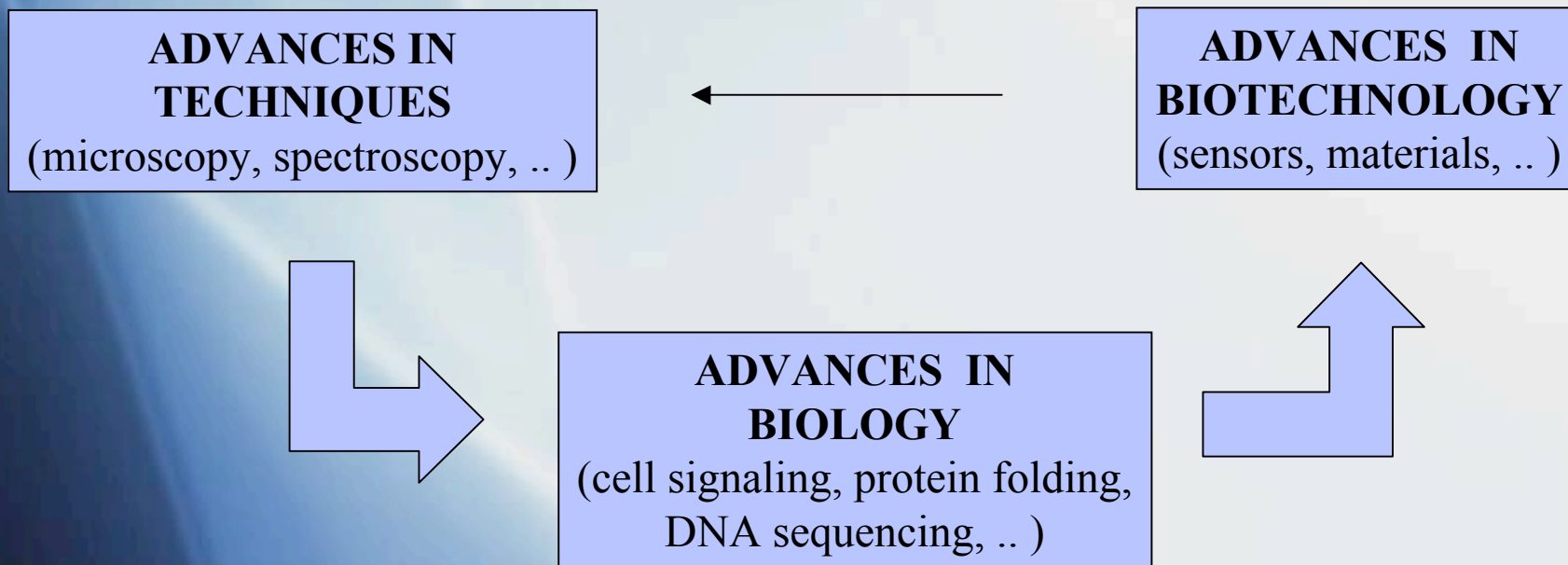

“New Truths become evident when new tools become available”
(Rosalyn Yalow, Nobel Laureate)

IMAGINE ..



... if there were no light microscopes

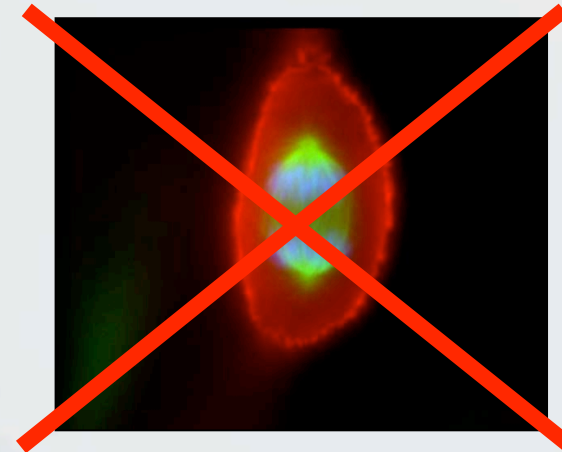
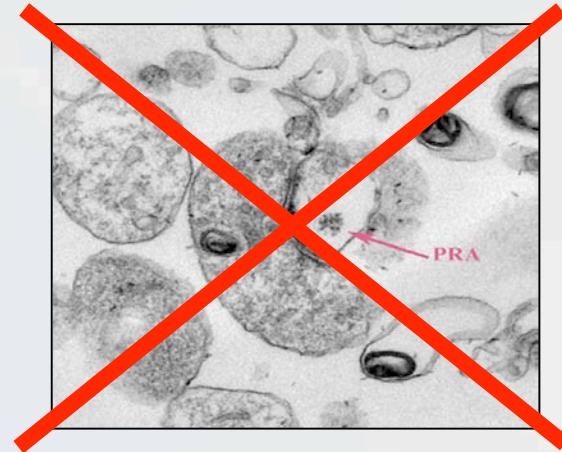
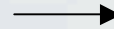

From DNA to AMINOACIDS to PROTEINS

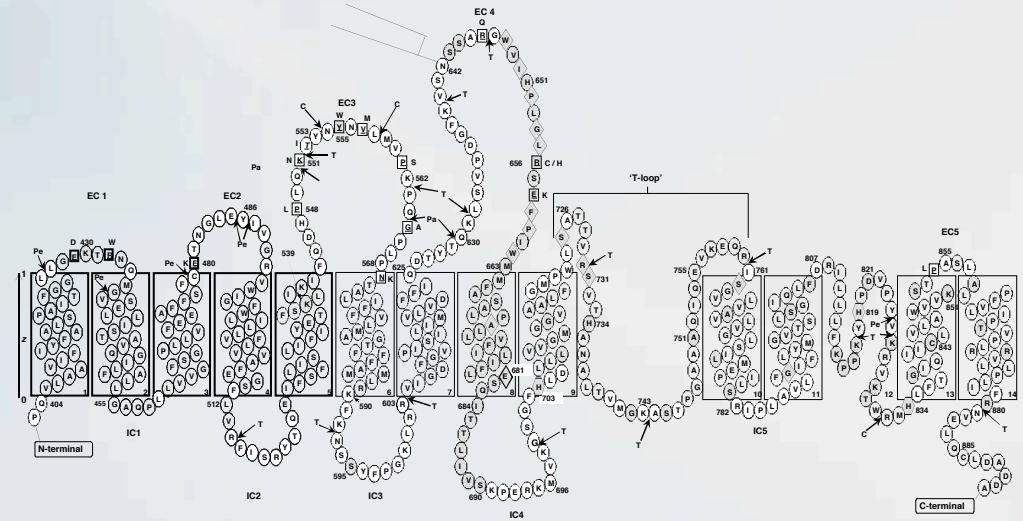
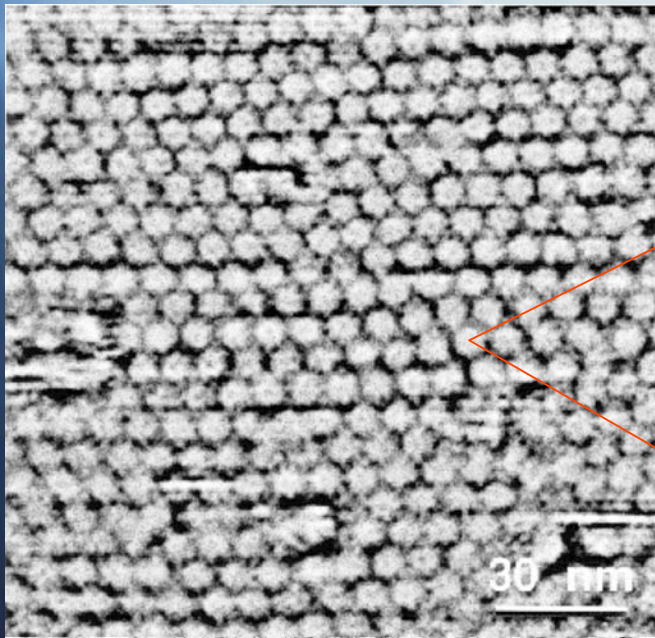

Protein ~ smallest functional unit !

HOW TO MEASURE PROTEINS ?

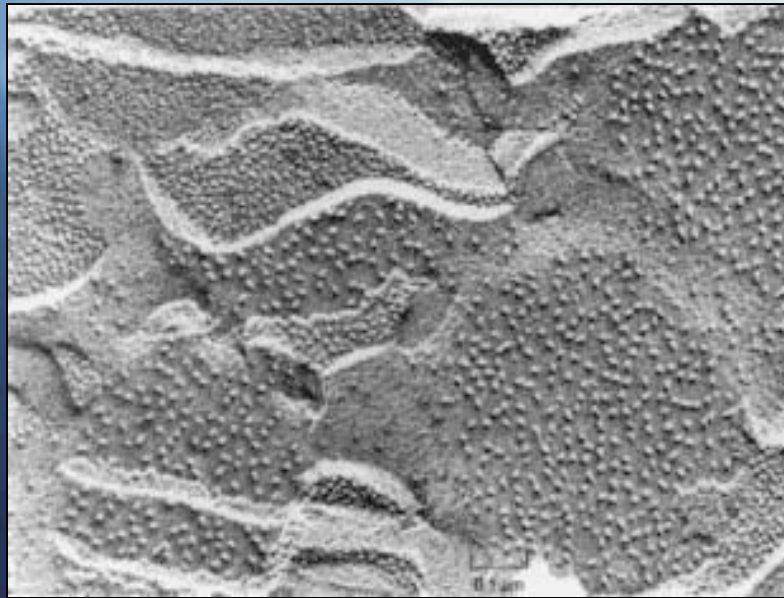

Freeze-fracture electron micrograph of the thylakoid membranes from the chloroplast of a plant cell.

A. Engel, MSB Biozentrum, Basel, Switzerland.

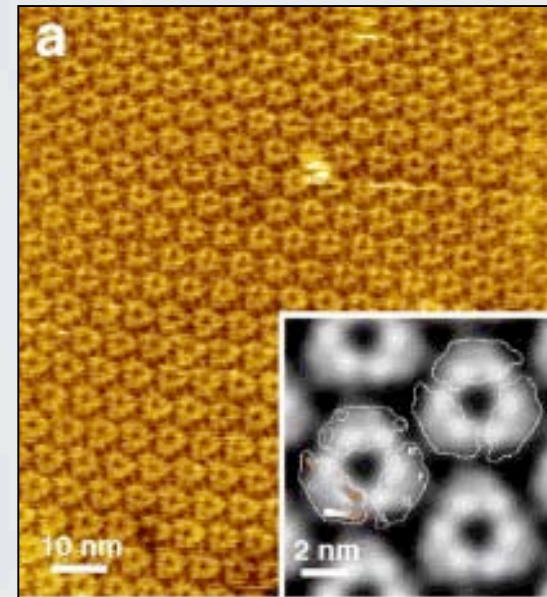

AFM topographs of purple membrane from *Halobacterium salinarium*.

SPATIAL RESOLUTION VS. CHEMICAL INFORMATION

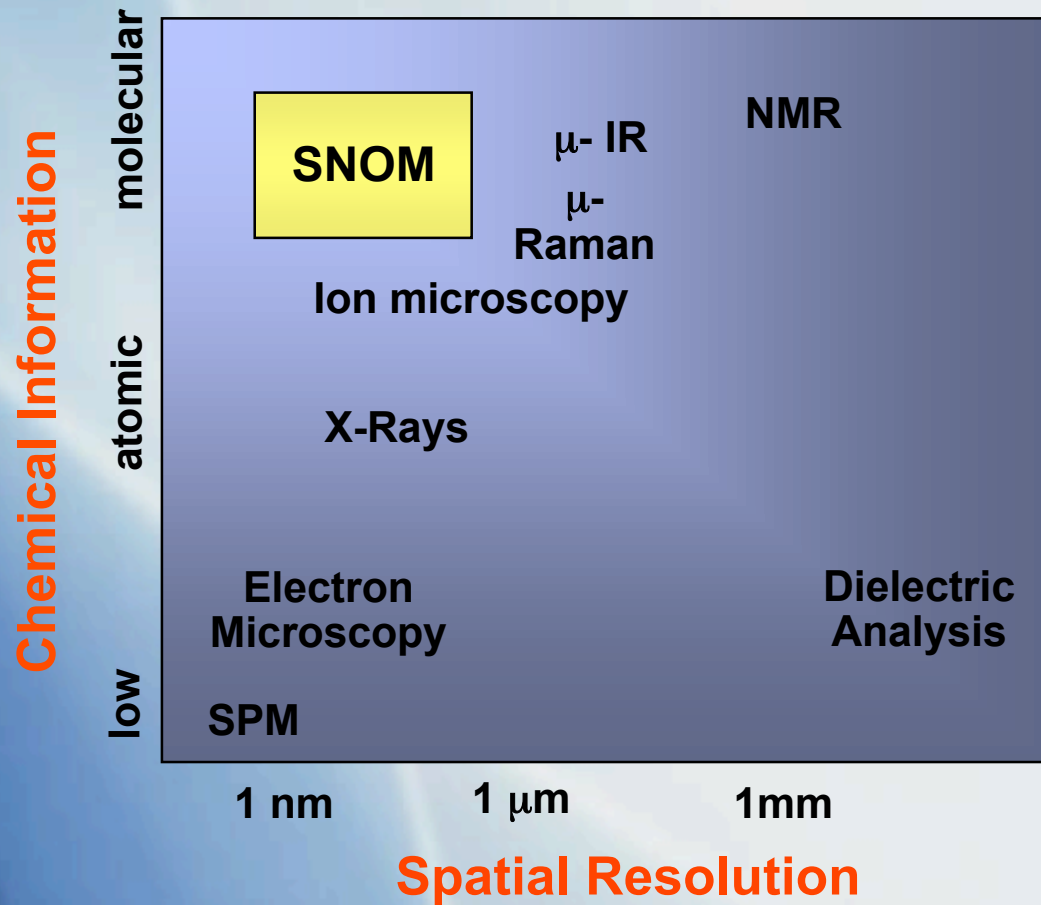

S. Stranick, NIST

HOW TO MEASURE PROTEINS ?

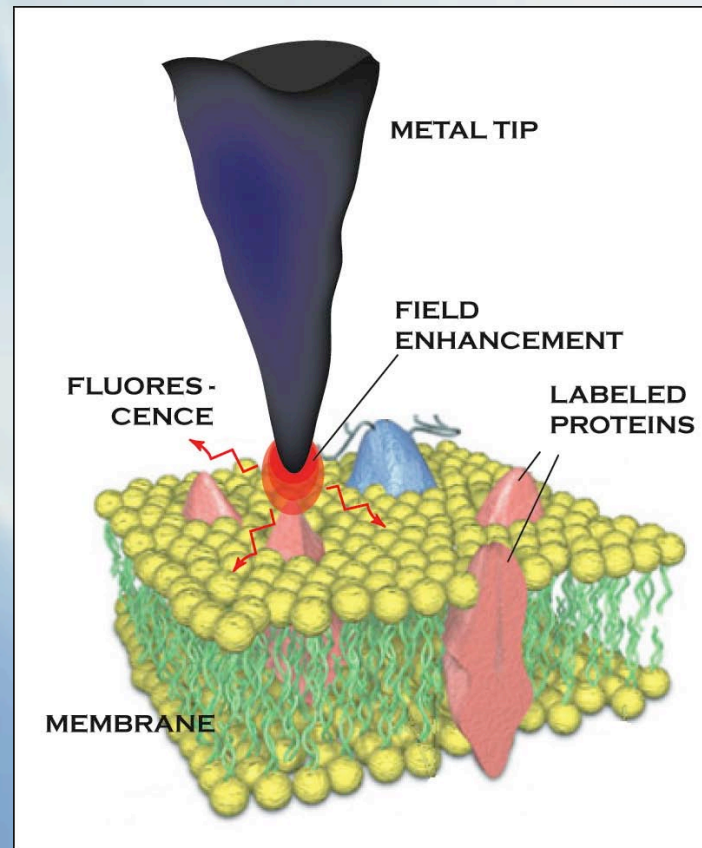

DOES IT WORK ?

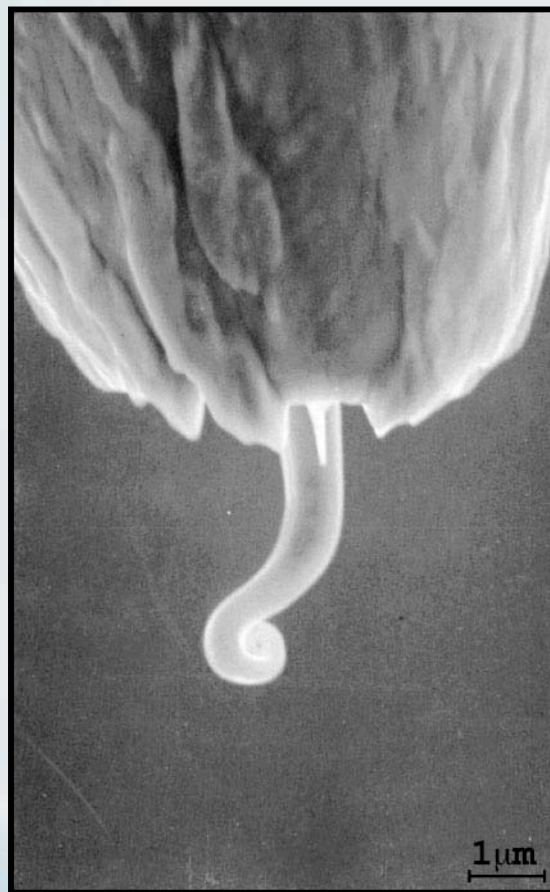

NEW GENERATION

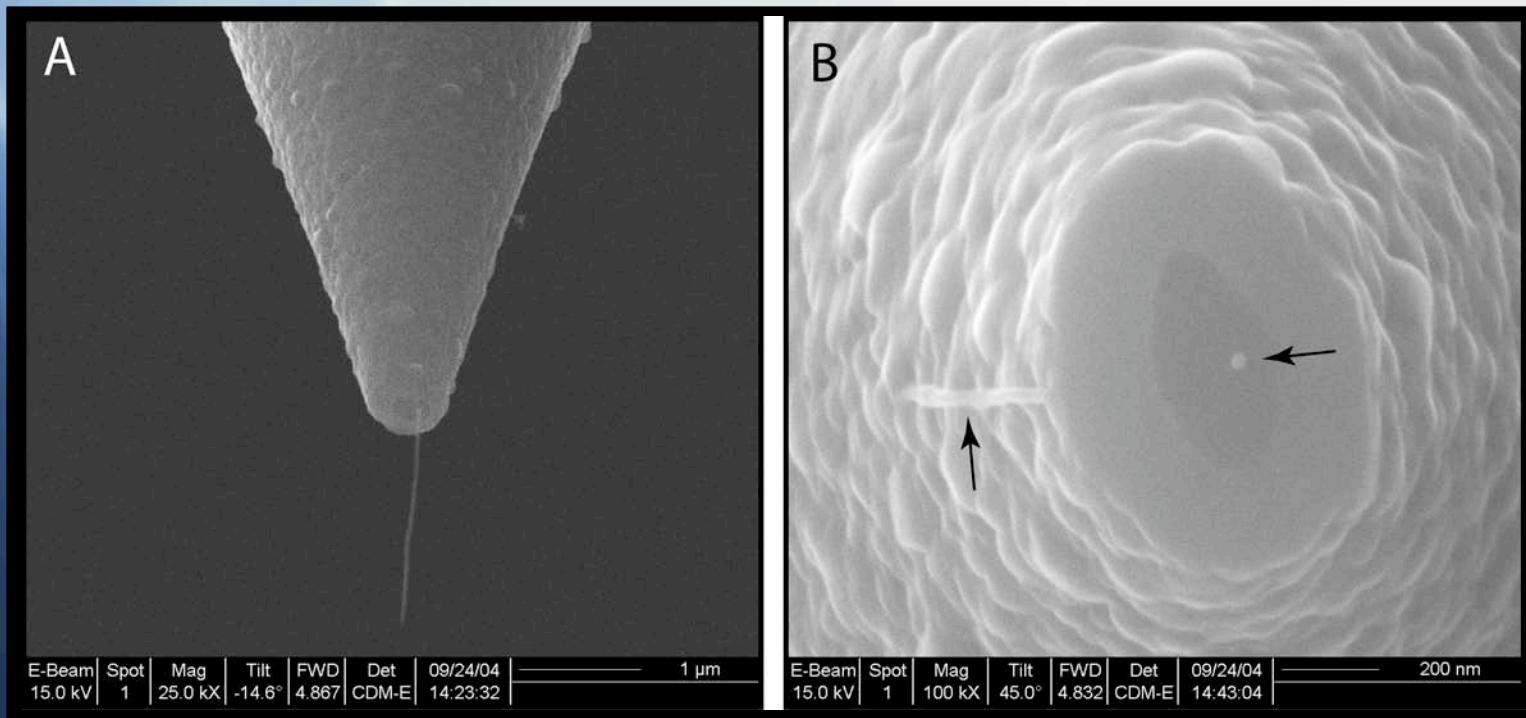

NEAR-FIELD TWO-PHOTON EXCITED FLUORESCENCE

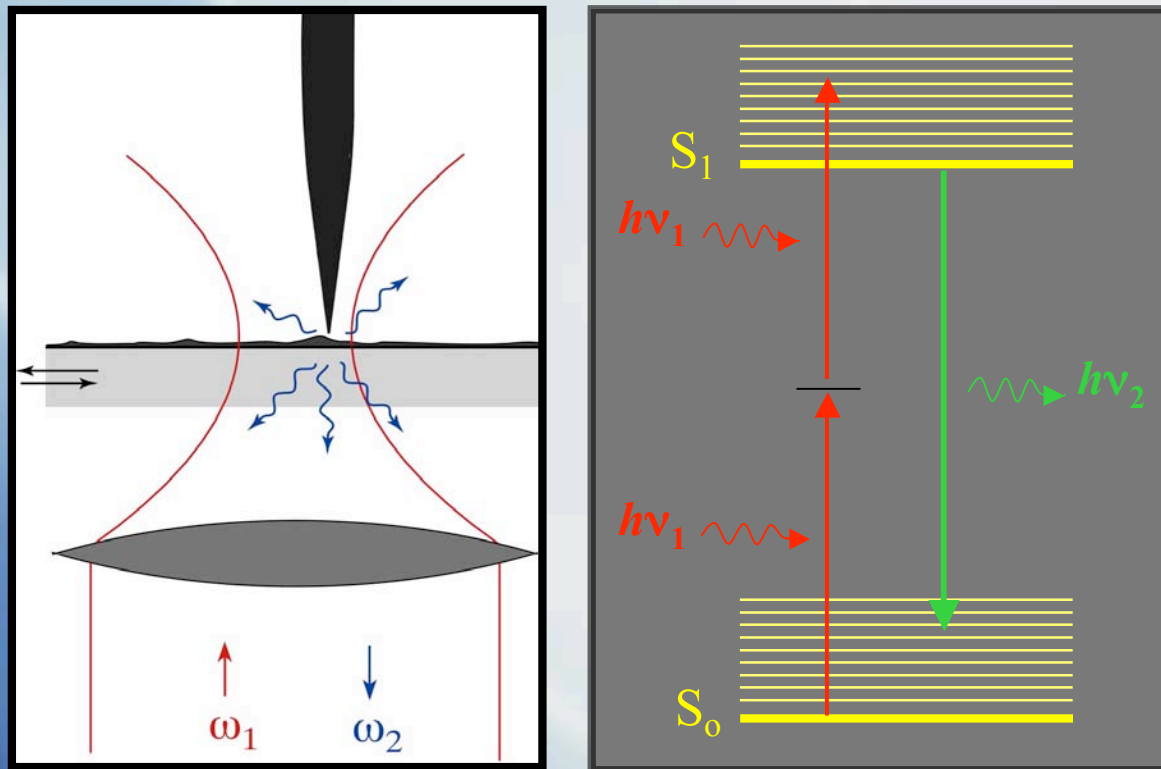

PHOTOSYNTHETIC MEMBRANE

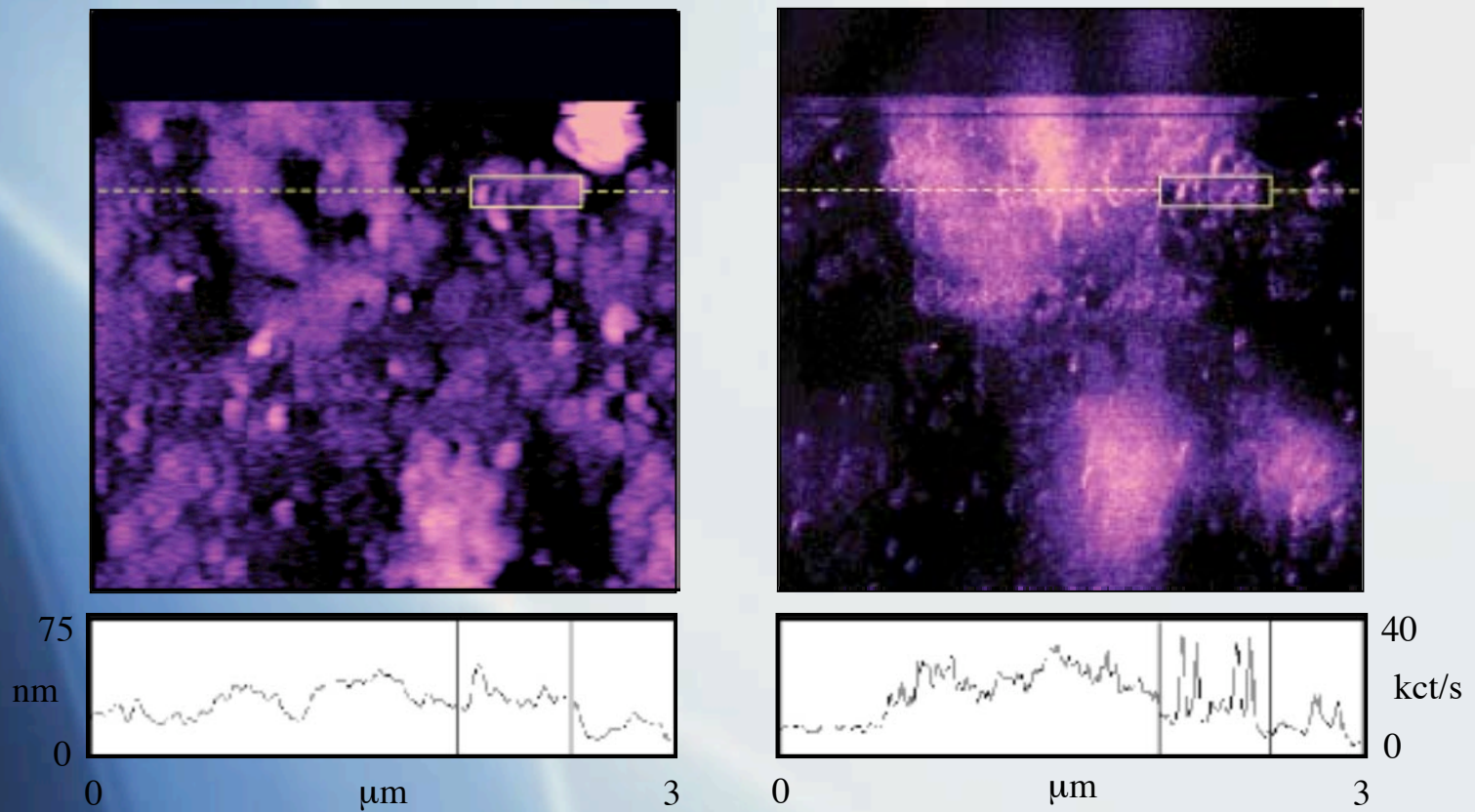

PRL 82, 4014 (1999).

NEAR-FIELD RAMAN SCATTERING ?

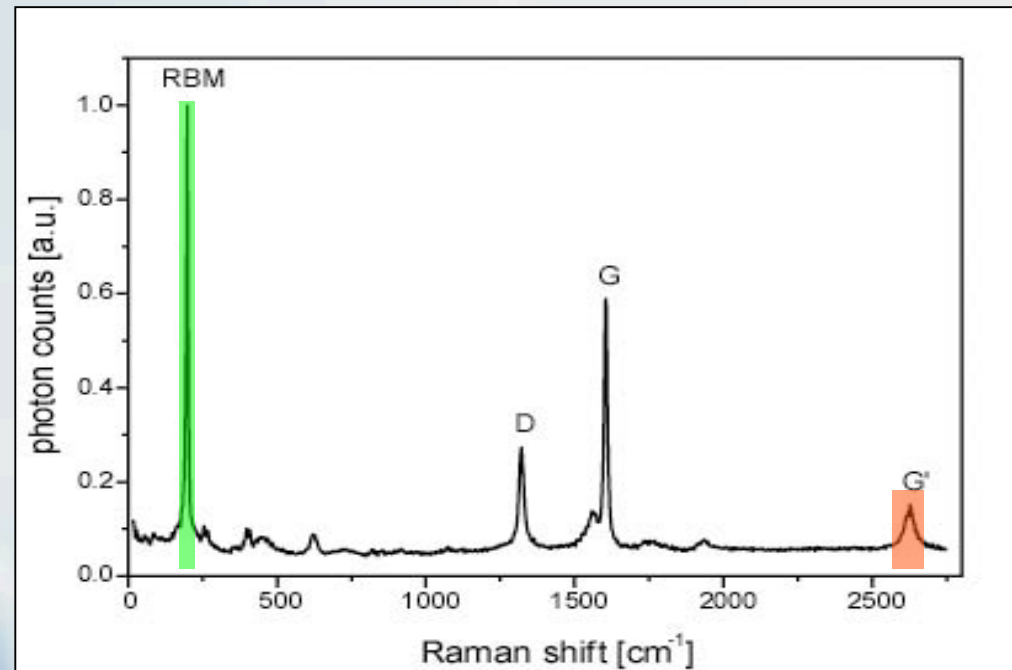
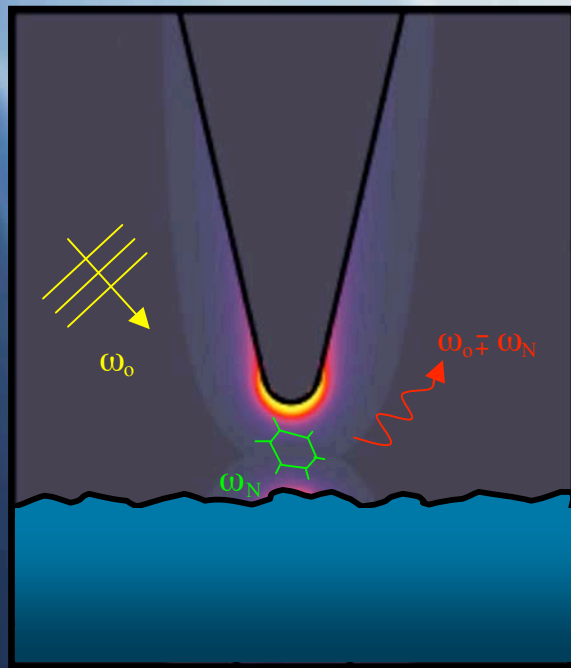

PRL **90**, 95503 (2003)

WHY RAMAN SCATTERING ?

Chemically specific (“fingerprint”)

Intrinsic properties of molecular structures (no need for labels)

“No” photo-bleaching.

Raman signals can be locally enhanced by up to 10^{14} (SERS).

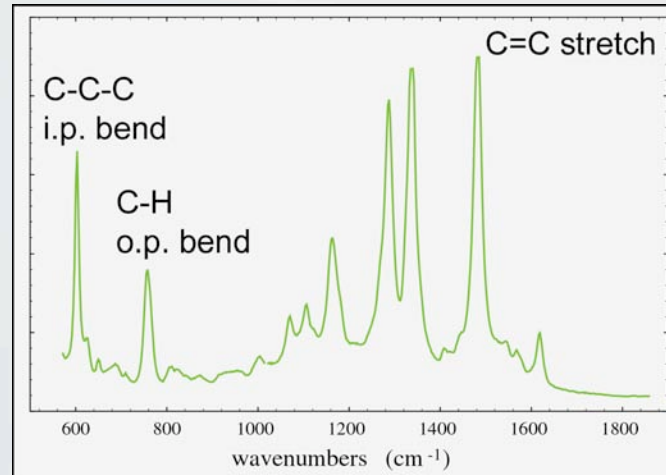

LEARN WITH EFFICIENT MOLECULES ..

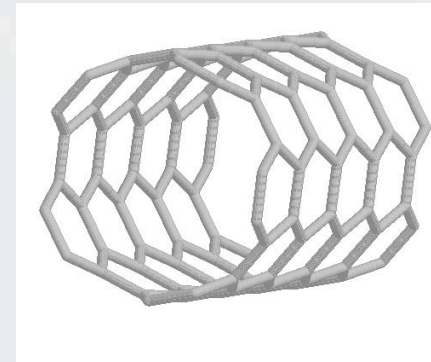
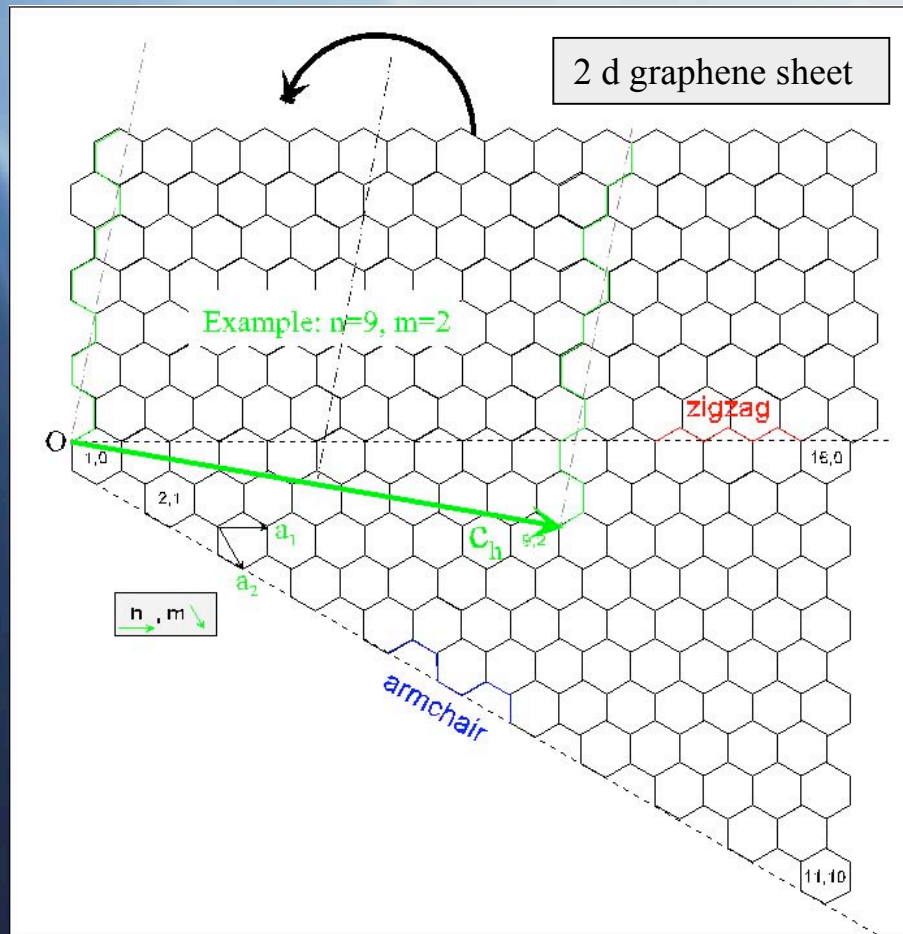

diameter: 0.7 - 2nm
length: up to several 10 μm

→ one dimensional systems

- well defined topography
- large σ_{Raman}
- resonance enhancement

THE ACTORS

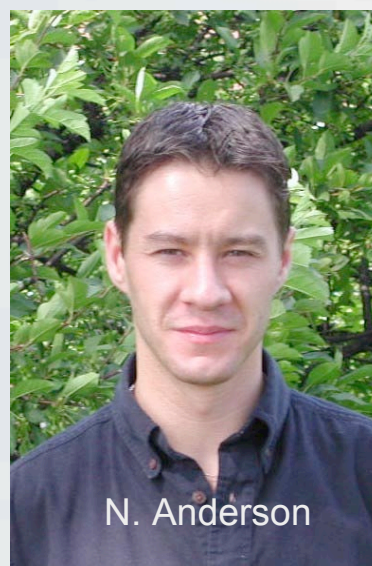

NEAR-FIELD RAMAN SCATTERING

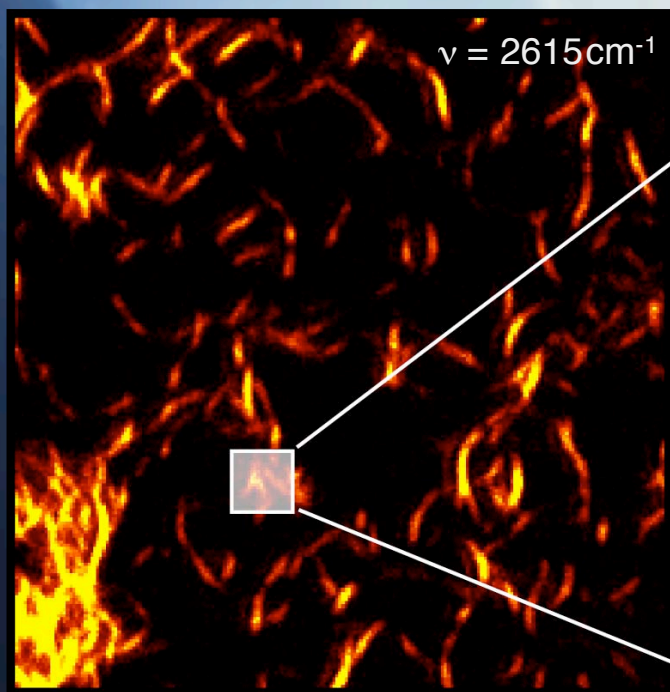

Diffraction limited :

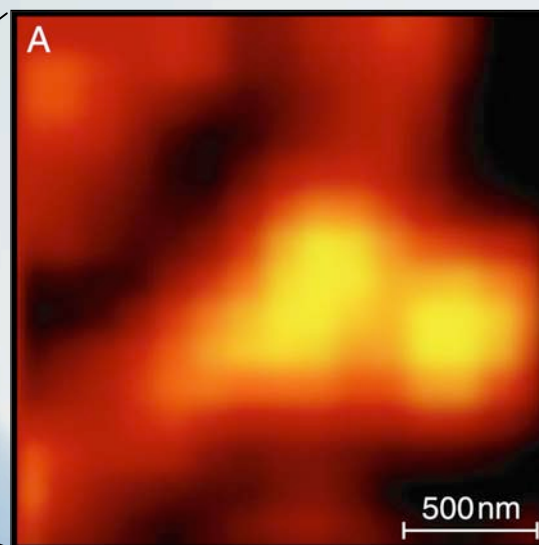

Near-field :

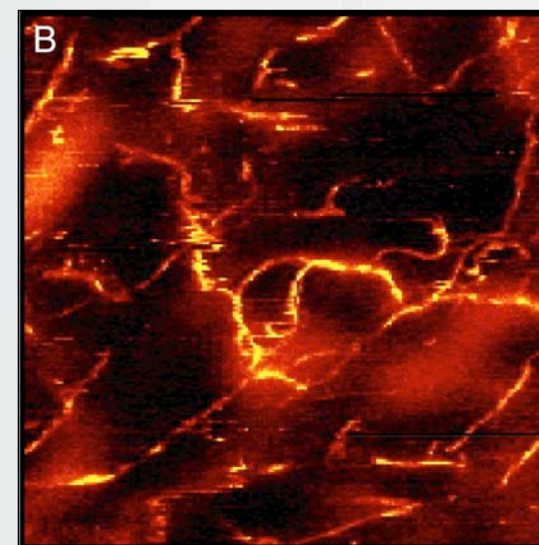

HIGH-RESOLUTION OPTICAL SPECTROSCOPY

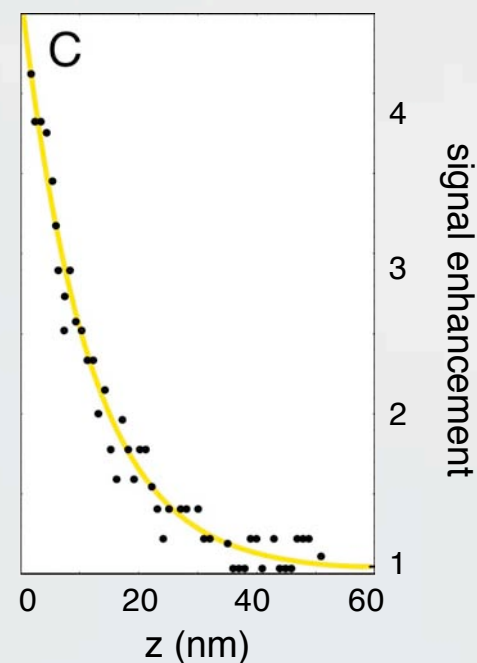
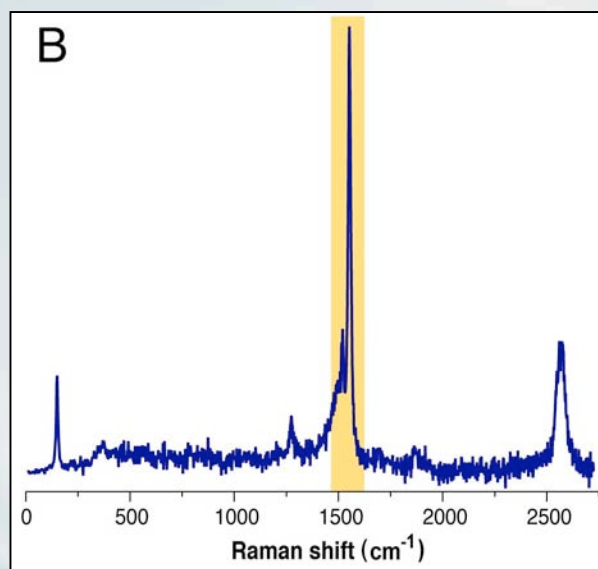
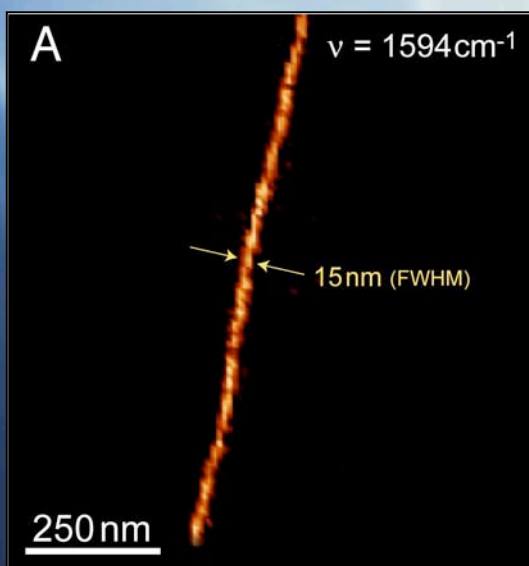

Featured in 2005 Guinness Book of World Records.

NEAR-FIELD SIGNAL ENHANCEMENT

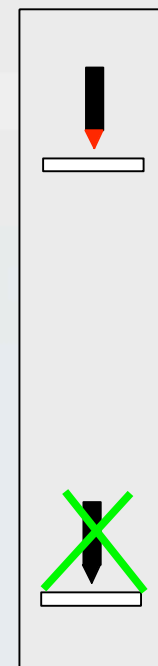
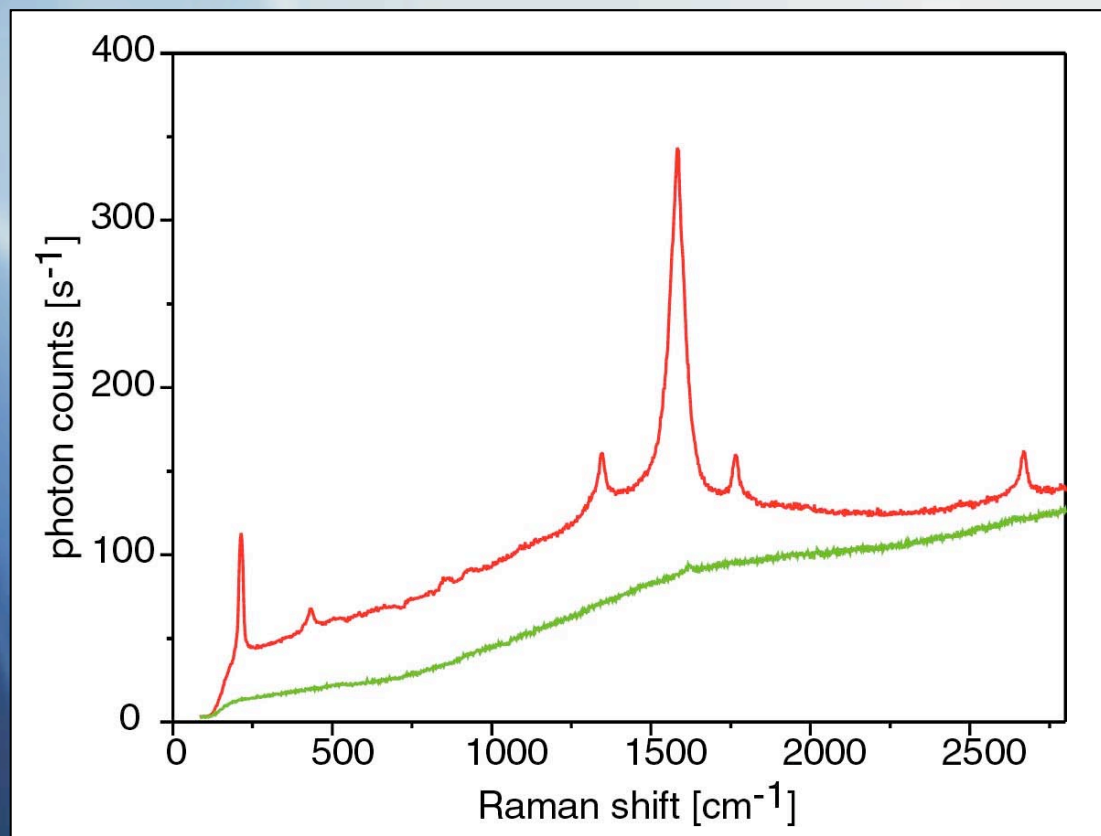

CHEMICAL SPECIFICITY

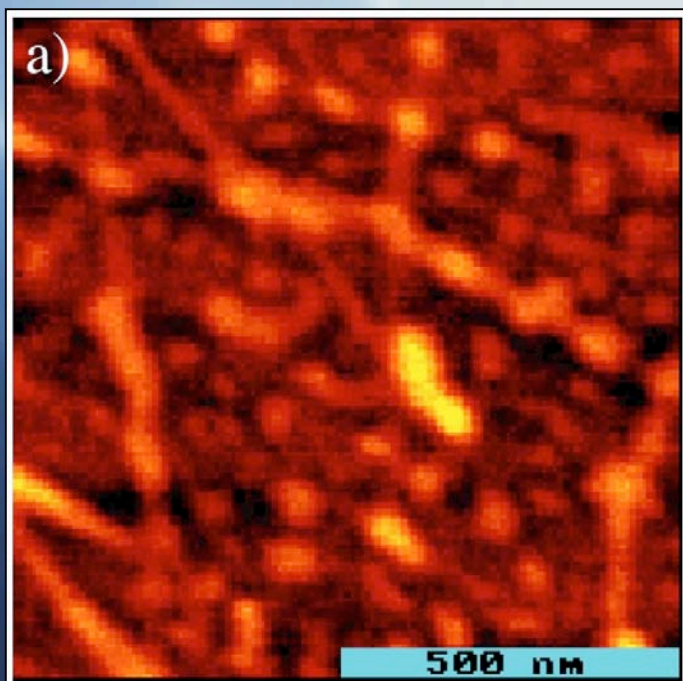

Topography

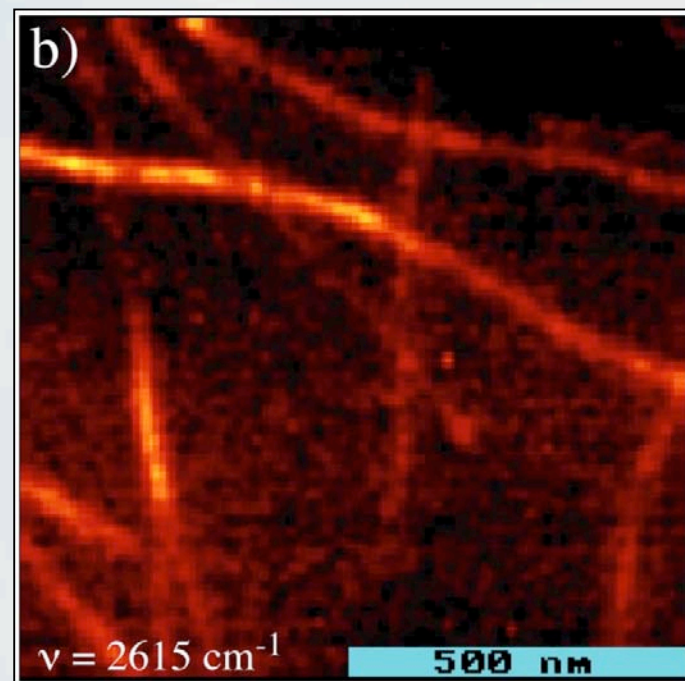

Raman scattering

PRL **90**, 95503 (2003)

LOCALIZATION OF DEFECTS AND DOPANTS

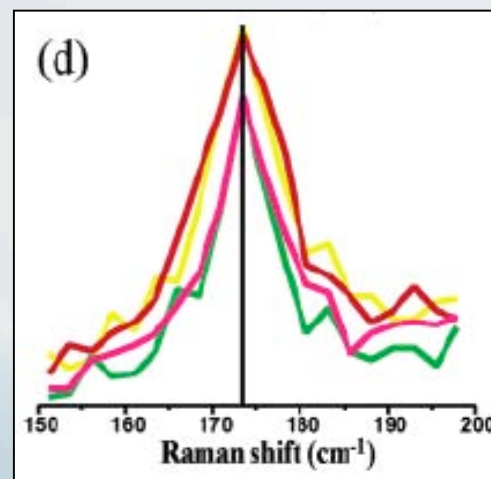
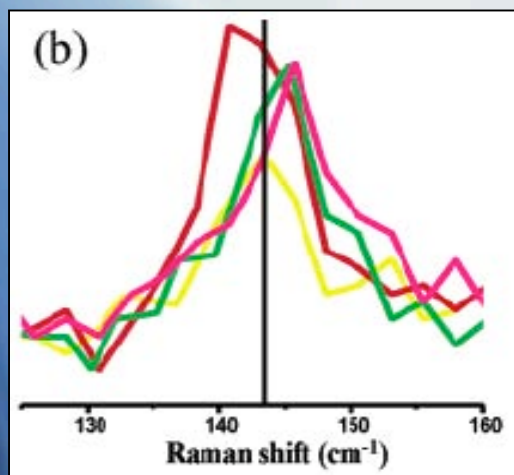
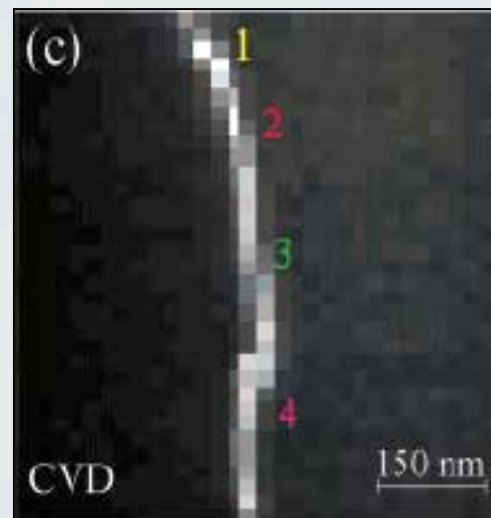
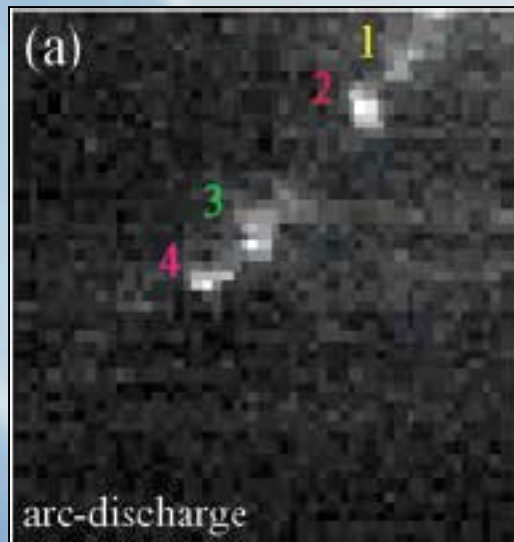

JACS (in print)

SO WHAT ABOUT PROTEINS ??

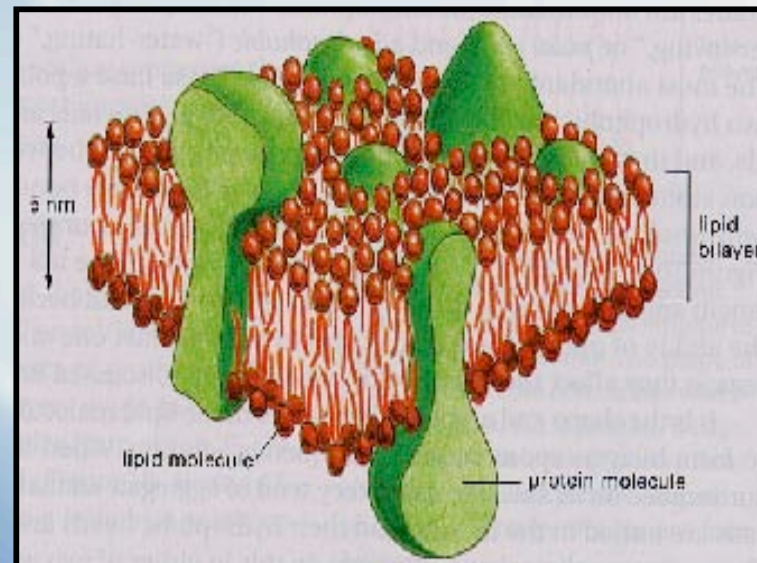

?

WHERE ARE THE MISSING **10** ORDERS OF MAGNITUDE ?

DIFFERENT APPROACH

METAL TIP AS A LOCALIZED PHOTON SOURCE

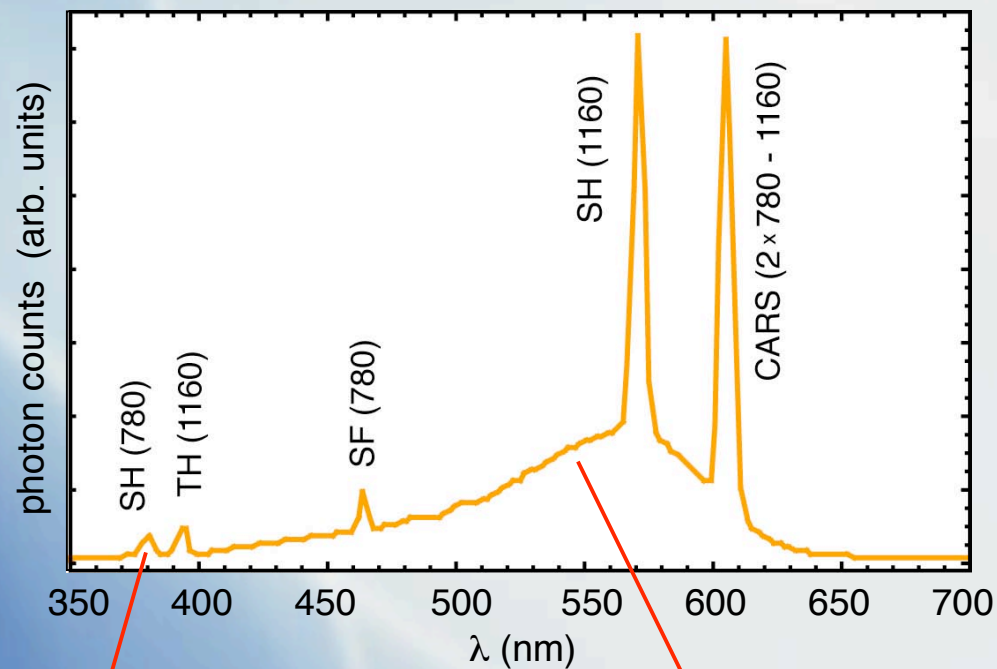

PRL **90**, 013903 (2003)

PRB **90**, 013903 (2003)

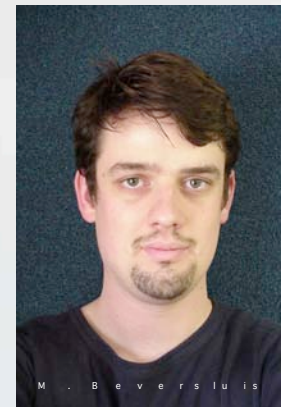

LET'S BE REALISTIC ..

FLUORESCENT LABELING

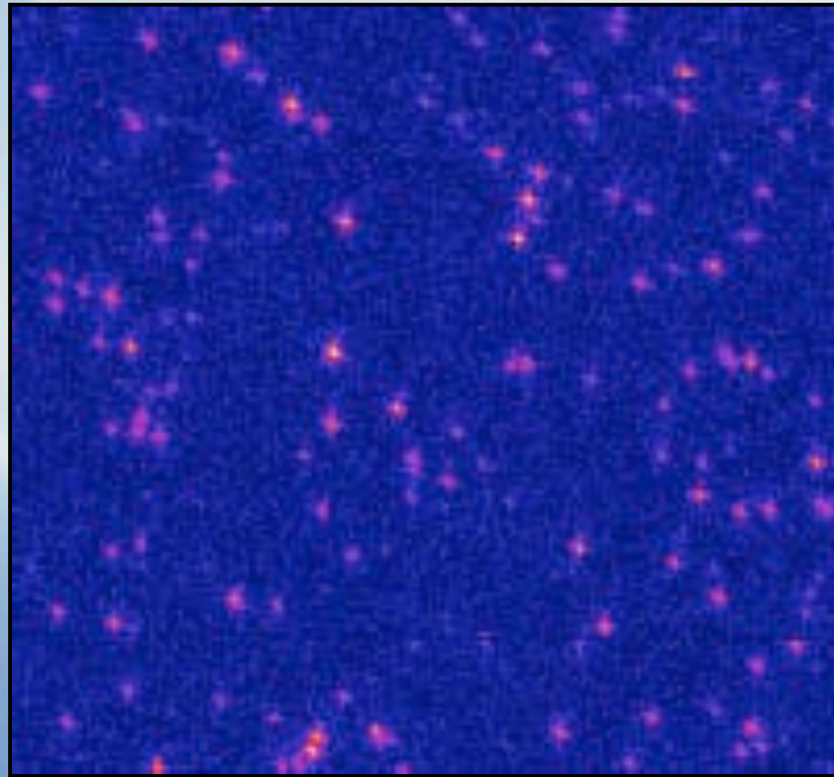

TEXTBOOK (Cambridge Univ. Press)

PRINCIPLES
OF
NANO-OPTICS

Lukas Novotny

The Institute of Optics
University of Rochester, Rochester, New York

Bert Hecht

Institute of Physics
University of Basel, Basel, Switzerland

FLUORESCENT MOLECULES

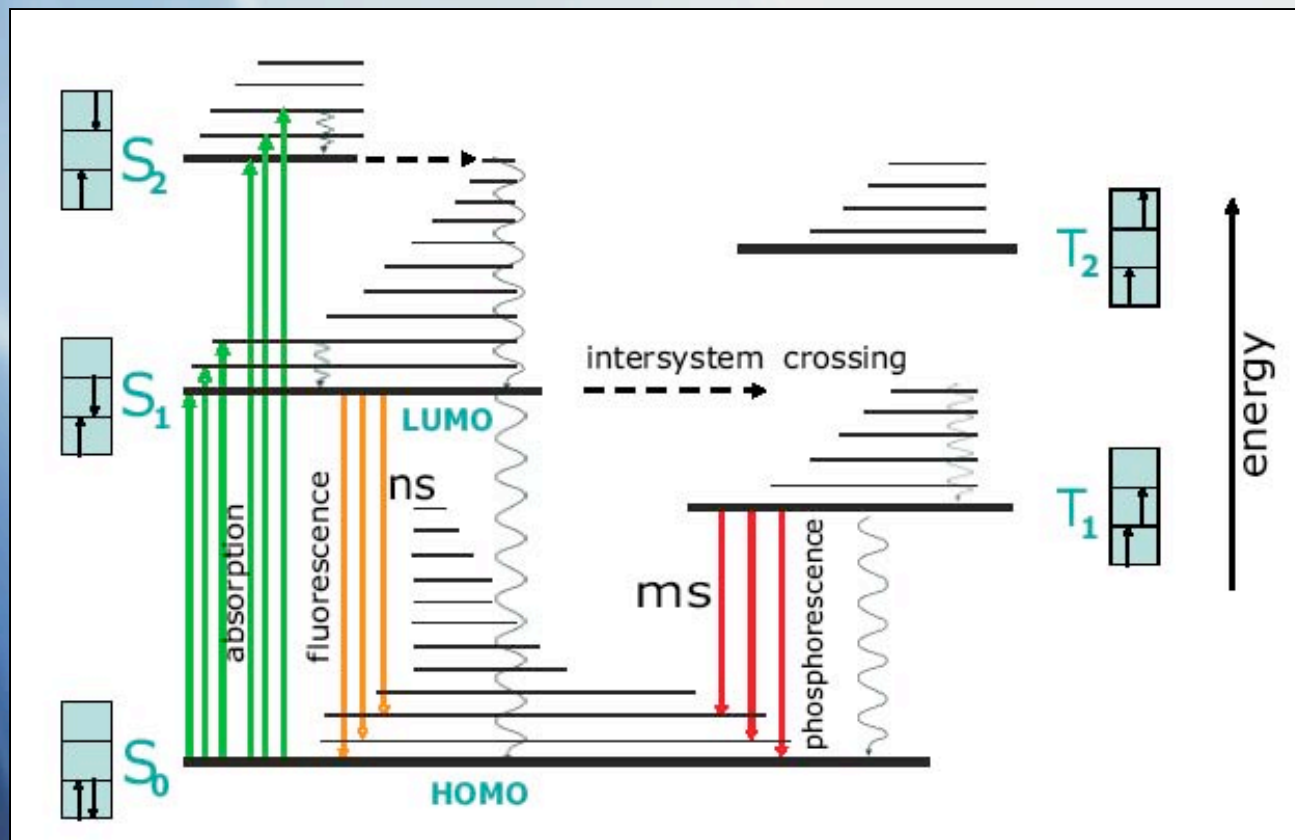

$$\text{Excitation rate} : \sim |\boldsymbol{\mu} \cdot \mathbf{E}|^2$$

EXCITATION/DETECTION OF SINGLE MOLECULES

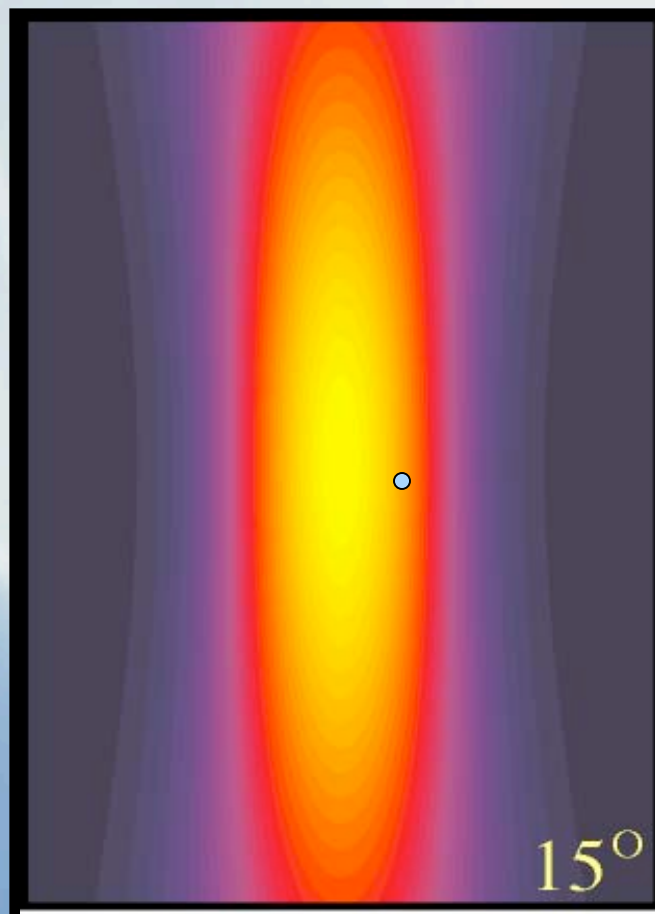

REDUCING INTERACTION VOLUME

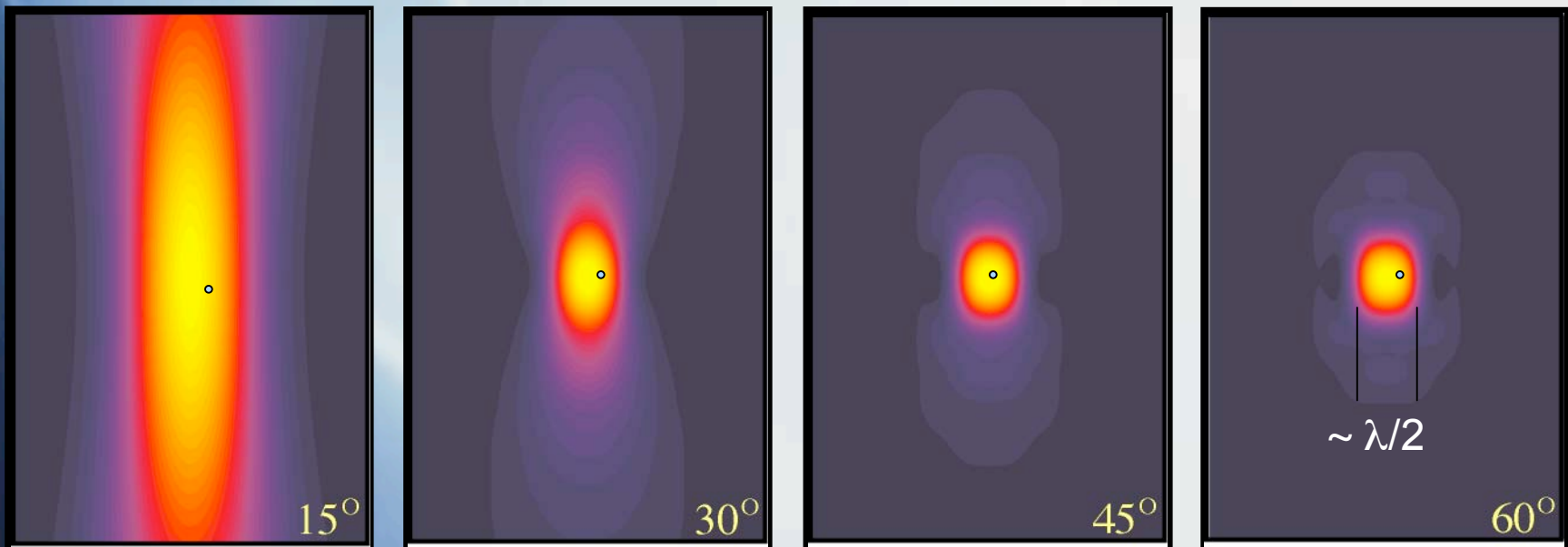

SINGLE MOLECULE DETECTION

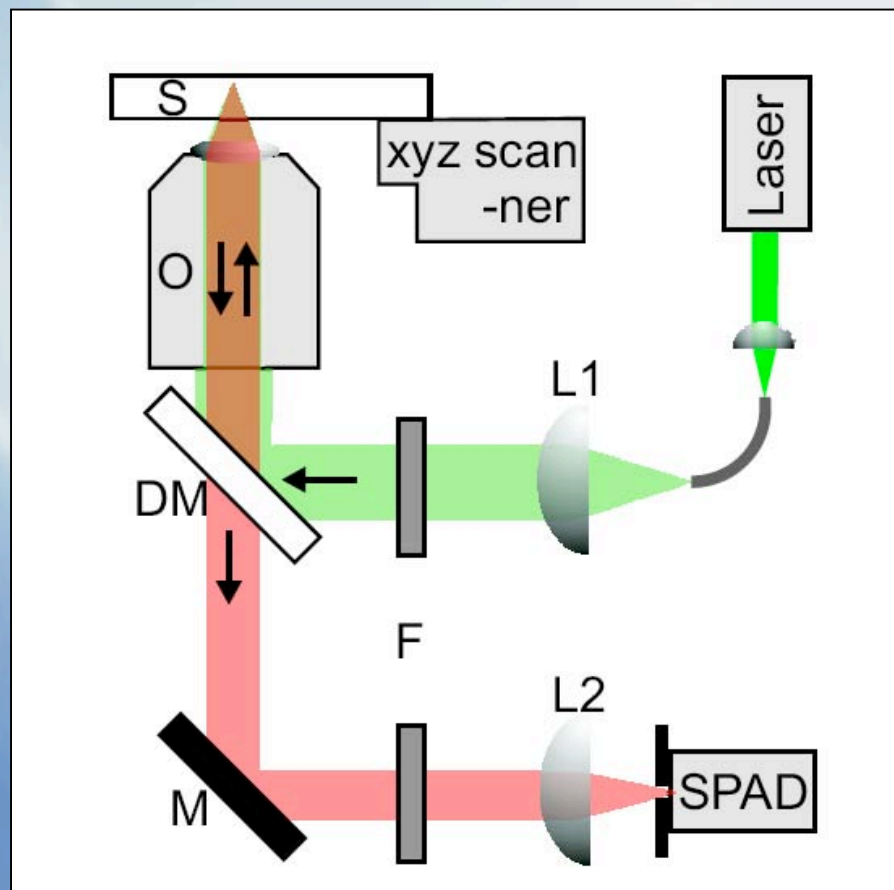

EXAMPLE

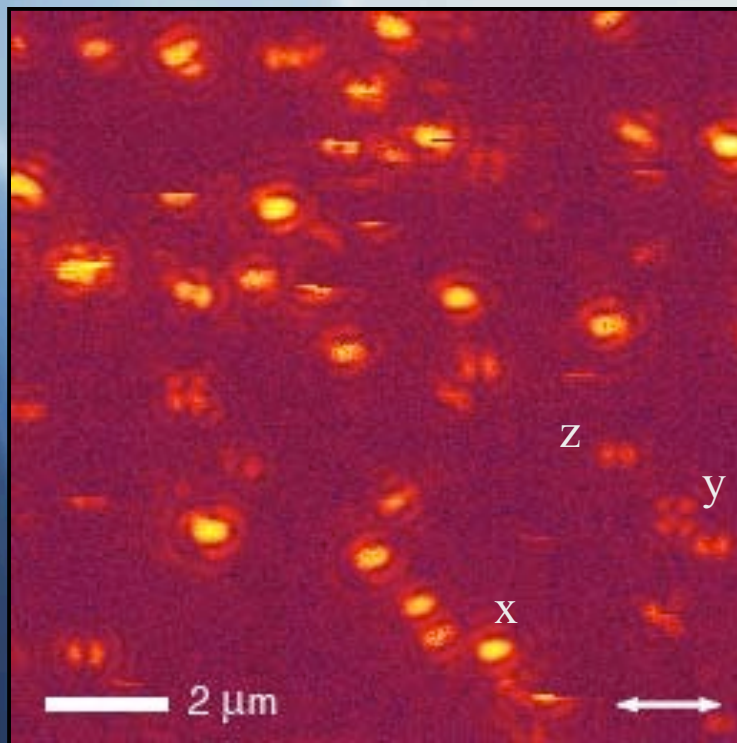

Nile Blue molecules

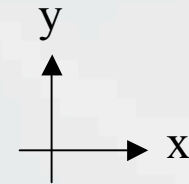

fluorescence rate \sim excitation rate

$$\text{contrast} \sim |\boldsymbol{\mu} \cdot \mathbf{E}(x,y;z_0)|^2$$

FIELDS NEAR A STRONGLY
FOCUSED BEAM ?!

PLANE WAVES

$$\mathbf{E}(x) = \mathbf{E}_o e^{i k_x x}$$

→

$$\mathbf{E}(x, t) = \text{Re} \{ \mathbf{E}(x) e^{-i \omega t} \}$$

$$\mathbf{E}(x, y, z) = \mathbf{E}_o e^{i(k_x x + k_y y + k_z z)} = \mathbf{E}_o e^{i \mathbf{k} \cdot \mathbf{r}}$$

$$k^2 = \frac{\omega^2}{c^2} = k_x^2 + k_y^2 + k_z^2$$

!

ANGULAR SPECTRUM REPRESENTATION

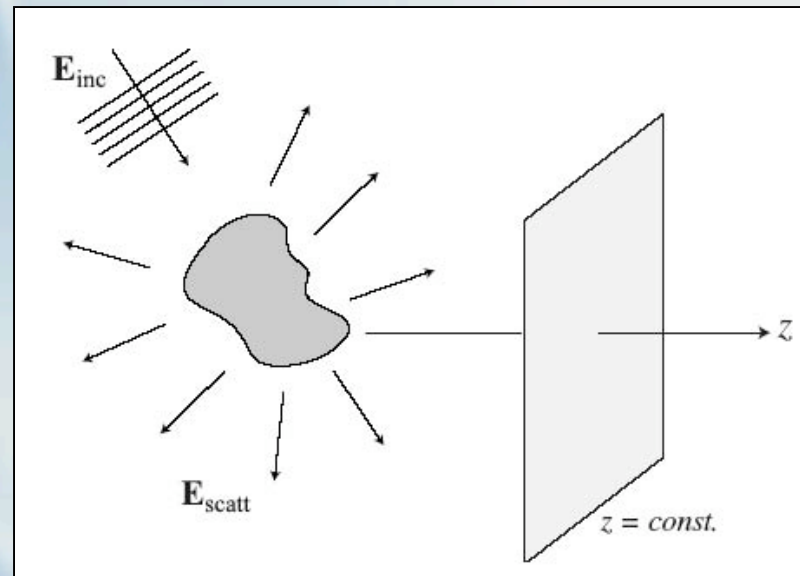

$$\hat{\mathbf{E}}(k_x, k_y; z) = \frac{1}{4\pi^2} \iint_{-\infty}^{\infty} \mathbf{E}(x, y, z) e^{-i[k_x x + k_y y]} dx dy$$

$$\mathbf{E}(x, y, z) = \iint_{-\infty}^{\infty} \hat{\mathbf{E}}(k_x, k_y; z) e^{i[k_x x + k_y y]} dk_x dk_y$$

$$(\nabla^2 + k^2) \mathbf{E}(\mathbf{r}) = 0 \quad !$$

ANGULAR SPECTRUM REPRESENTATION

$$\hat{\mathbf{E}}(k_x, k_y; z) = \hat{\mathbf{E}}(k_x, k_y; 0) e^{\pm i k_z z}$$

$$k_z \equiv \sqrt{(k^2 - k_x^2 - k_y^2)} \quad \text{with } \text{Im}\{k_z\} \geq 0$$

$$\mathbf{E}(x, y, z) = \iint_{-\infty}^{\infty} \hat{\mathbf{E}}(k_x, k_y; 0) e^{i[k_x x + k_y y \pm k_z z]} dk_x dk_y$$

Plane waves :	$e^{i[k_x x + k_y y]} e^{\pm i k_z z},$	$k_x^2 + k_y^2 \leq k^2$
Evanescent waves :	$e^{i[k_x x + k_y y]} e^{- k_z z },$	$k_x^2 + k_y^2 > k^2$

ANGULAR SPECTRUM REPRESENTATION

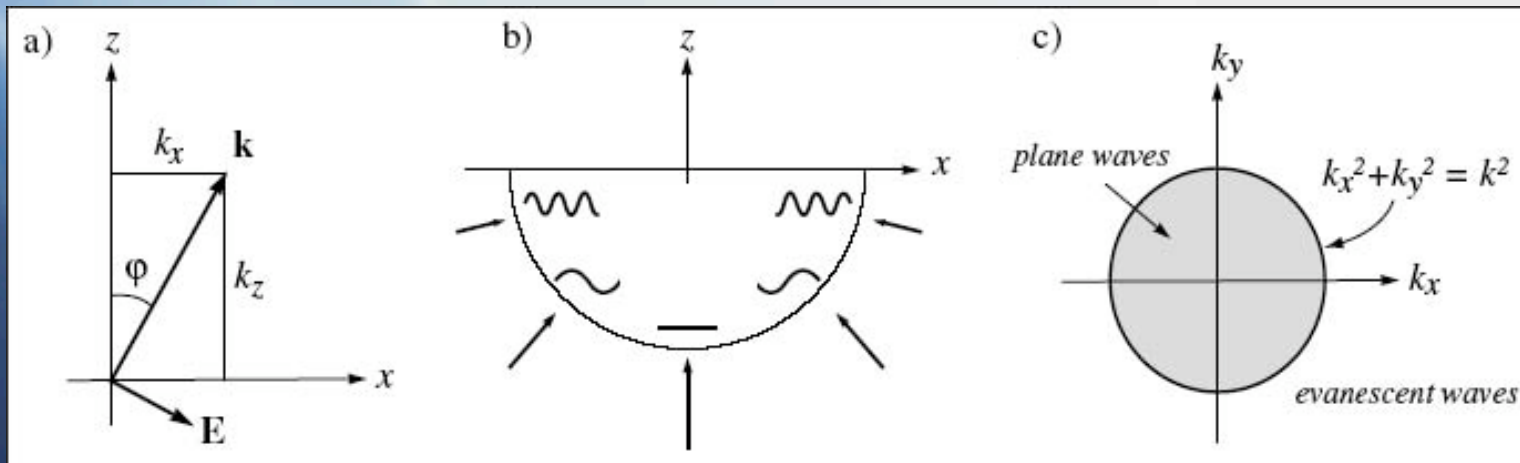

PARAXIAL APPROXIMATION / GAUSSIAN BEAMS

$$k_z = k \sqrt{1 - (k_x^2 + k_y^2)/k^2} \approx k - \frac{(k_x^2 + k_y^2)}{2k}$$

$$\mathbf{E}(x', y', 0) = \mathbf{E}_o e^{-\frac{x'^2 + y'^2}{w_o^2}}$$

→

$$\hat{\mathbf{E}}(k_x, k_y; 0) = \mathbf{E}_o \frac{w_o^2}{4\pi} e^{-(k_x^2 + k_y^2) \frac{w_o^2}{4}}$$

$$\mathbf{E}(x, y, z) = \mathbf{E}_o \frac{w_o^2}{4\pi} e^{ikz} \iint_{-\infty}^{\infty} e^{-(k_x^2 + k_y^2) \left(\frac{w_o^2}{4} + \frac{iz}{2k}\right)} e^{i[k_x x + k_y y]} dk_x dk_y$$

PARAXIAL APPROXIMATION / GAUSSIAN BEAMS

$$\mathbf{E}(\rho, z) = \mathbf{E}_o \frac{w_o}{w(z)} e^{-\frac{\rho^2}{w^2(z)}} e^{i[kz - \eta(z) + k\rho^2/2R(z)]}$$

$$z_o = \frac{k w_o^2}{2}$$

$$w(z) = w_o (1 + z^2/z_o^2)^{1/2} \quad \text{beam waist}$$

$$R(z) = z (1 + z_o^2/z^2) \quad \text{wavefront radius}$$

$$\eta(z) = \arctan z/z_o \quad \text{phase correction}$$

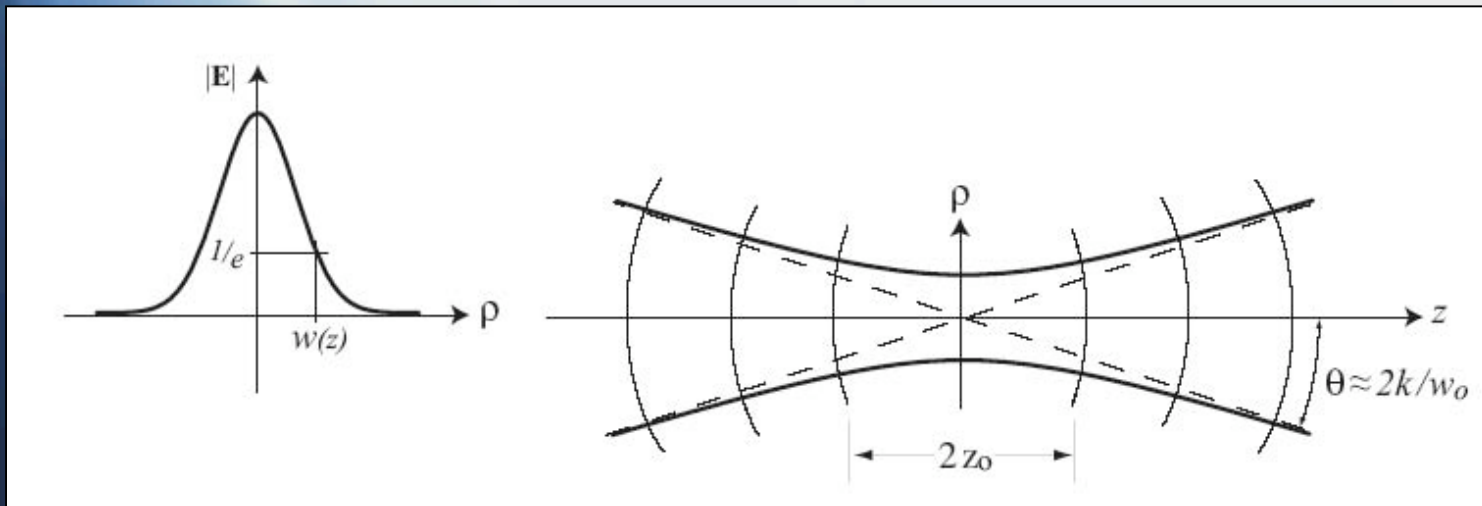

HIGHER-ORDER PARAXIAL BEAMS

$$\mathbf{E}_{nm}^H(x, y, z) = w_o^{n+m} \frac{\partial^n}{\partial x^n} \frac{\partial^m}{\partial y^m} \mathbf{E}(x, y, z)$$

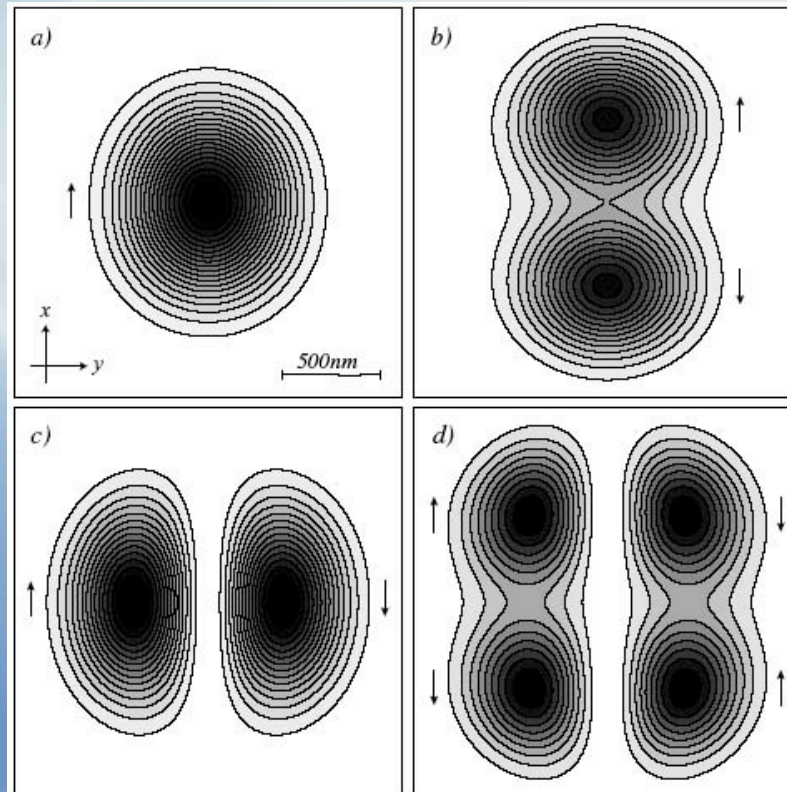

FARFIELDS OF THE ANGULAR SPECTRUM

$$\mathbf{E}_\infty(s_x, s_y, s_z) = \lim_{kr \rightarrow \infty} \iint_{(k_x^2 + k_y^2) \leq k^2} \hat{\mathbf{E}}(k_x, k_y; 0) e^{ikr \left[\frac{k_x}{k} s_x + \frac{k_y}{k} s_y \pm \frac{k_z}{k} s_z \right]} dk_x dk_y$$

$$\mathbf{s} = (s_x, s_y, s_z) = \left(\frac{x}{r}, \frac{y}{r}, \frac{z}{r} \right)$$

Method of stationary phase:

$$\mathbf{E}_\infty(s_x, s_y, s_z) = -2\pi i k s_z \hat{\mathbf{E}}(k s_x, k s_y; 0) \frac{e^{ikr}}{r}$$

$$\mathbf{s} = (s_x, s_y, s_z) = \left(\frac{k_x}{k}, \frac{k_y}{k}, \frac{k_z}{k} \right)$$

Example:

$$\begin{aligned} \hat{\mathbf{E}}(k_x, k_y; 0) &= \frac{\mathbf{E}_o}{4\pi^2} \int_{-L_y}^{+L_y} \int_{-L_x}^{+L_x} e^{-i[k_x x' + k_y y']} dx' dy' \\ &= \mathbf{E}_o \frac{L_x L_y}{\pi^2} \frac{\sin(k_x L_x)}{k_x L_x} \frac{\sin(k_y L_y)}{k_y L_y}, \end{aligned}$$

ANGULAR SPECTRUM IN TERMS OF FARFIELD

$$\hat{\mathbf{E}}(k_x, k_y; 0) = \frac{ir e^{-ikr}}{2\pi k_z} \mathbf{E}_\infty(k_x, k_y)$$

$$\mathbf{E}(x, y, z) = \frac{ir e^{-ikr}}{2\pi} \iint_{(k_x^2 + k_y^2) \leq k^2} \mathbf{E}_\infty(k_x, k_y) e^{i[k_x x + k_y y \pm k_z z]} \frac{1}{k_z} dk_x dk_y$$

For $k_z \sim k$: Fourier Optics !!

REFRACTION AT LENS

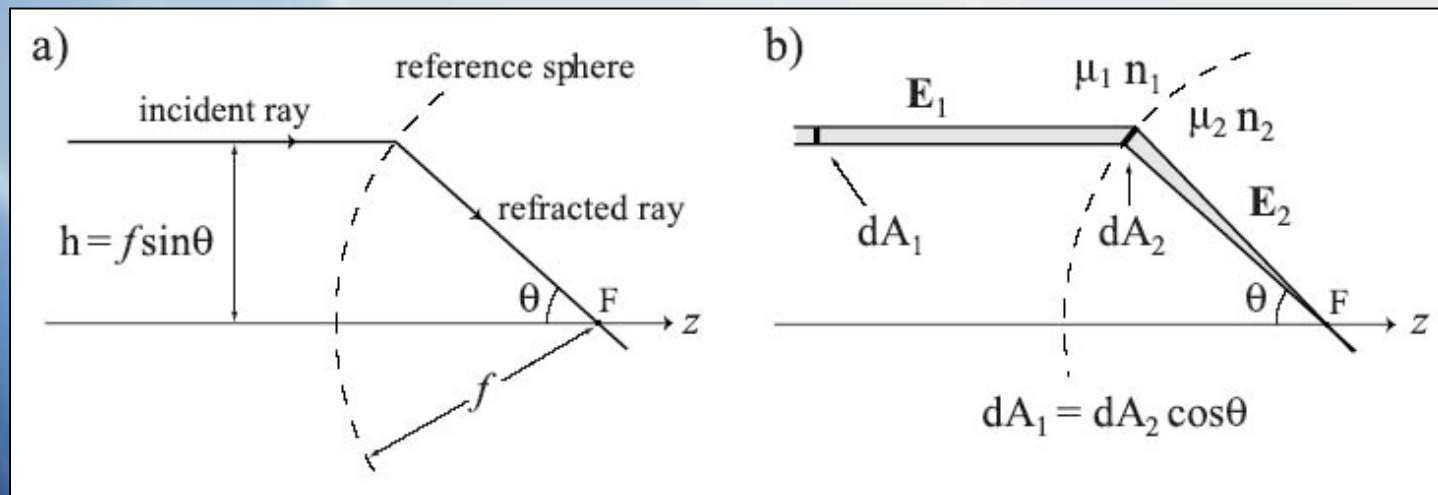

Sine Condition
(aplanatic system)

$$h = f \sin(\theta)$$

Ray Continuity
(energy conservation)

$$|\mathbf{E}_2| = |\mathbf{E}_1| \sqrt{\frac{n_1}{n_2}} \sqrt{\frac{\mu_2}{\mu_1}} \cos^{1/2} \theta$$

FOCUSING OF FIELDS

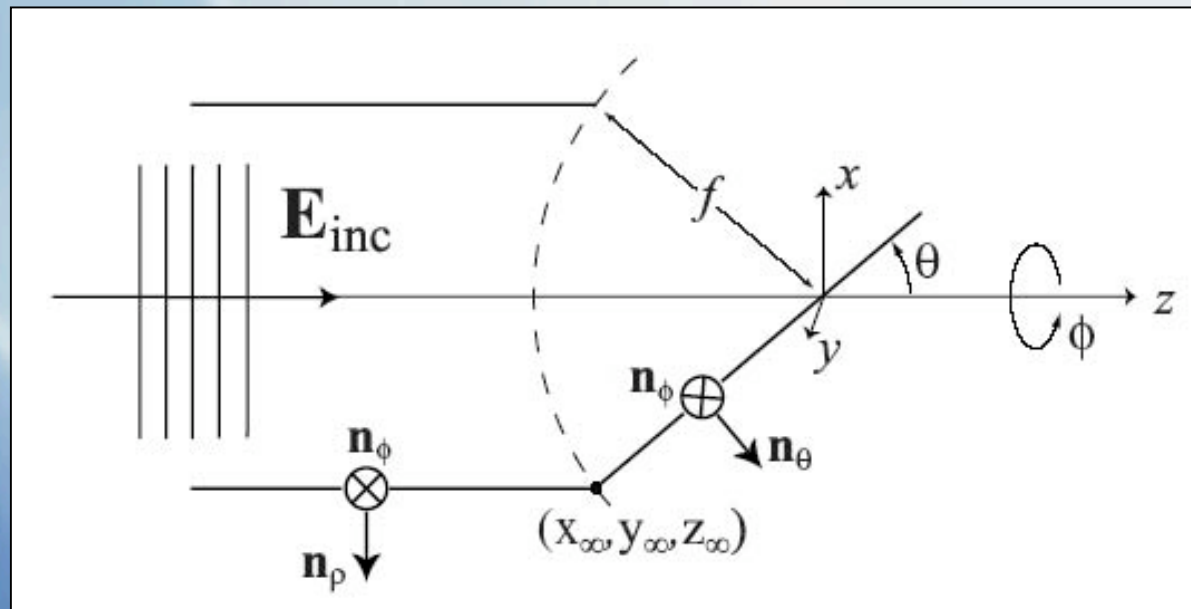

$$\mathbf{E}_{\infty} = \left[t^s [\mathbf{E}_{inc} \cdot \mathbf{n}_{\phi}] \mathbf{n}_{\phi} + t^p [\mathbf{E}_{inc} \cdot \mathbf{n}_{\rho}] \mathbf{n}_{\theta} \right] \sqrt{\frac{n_1}{n_2}} (\cos \theta)^{1/2}$$

EXPRESS IN TERMS OF ANGLES

$$\mathbf{n}_\rho = \cos \phi \mathbf{n}_x + \sin \phi \mathbf{n}_y ,$$

$$\mathbf{n}_\phi = -\sin \phi \mathbf{n}_x + \cos \phi \mathbf{n}_y ,$$

$$\mathbf{n}_\theta = \cos \theta \cos \phi \mathbf{n}_x + \cos \theta \sin \phi \mathbf{n}_y - \sin \theta \mathbf{n}_z$$

$$k_x = k \sin \theta \cos \phi, \quad k_y = k \sin \theta \sin \phi, \quad k_z = k \cos \theta$$

$$\frac{1}{k_z} dk_x dk_y = k \sin \theta d\theta d\phi$$

$$x = \rho \cos \varphi, \quad y = \rho \sin \varphi$$

$$\mathbf{E}(\rho, \varphi, z) = \frac{ikf e^{-ikf}}{2\pi} \int_0^{\theta_{max}} \int_0^{2\pi} \mathbf{E}_\infty(\theta, \phi) e^{ikz \cos \theta} e^{ik\rho \sin \theta \cos(\phi - \varphi)} \sin \theta d\phi d\theta$$

DEFINE INCIDENT FIELD

$$\mathbf{E}_{inc} = E_{inc} \mathbf{n}_x \quad t_{\theta}^s = t_{\theta}^p = 1 \quad :$$

$$\begin{aligned} \mathbf{E}_{\infty}(\theta, \phi) &= E_{inc}(\theta, \phi) [\cos \phi \mathbf{n}_{\theta} - \sin \phi \mathbf{n}_{\phi}] \sqrt{n_1/n_2} (\cos \theta)^{1/2} \\ &= E_{inc}(\theta, \phi) \frac{1}{2} \begin{bmatrix} (1 + \cos \theta) - (1 - \cos \theta) \cos 2\phi \\ -(1 - \cos \theta) \sin 2\phi \\ -2 \cos \phi \sin \theta \end{bmatrix} \sqrt{\frac{n_1}{n_2}} (\cos \theta)^{1/2} \end{aligned}$$

$(0, 0)$ mode :

$$E_{inc} = E_o e^{-(x_{\infty}^2 + y_{\infty}^2)/w_o^2} = E_o e^{-f^2 \sin^2 \theta / w_o^2}$$

INTEGRATE OVER ϕ

$$\int_0^{2\pi} \cos n\phi e^{ix \cos(\phi-\varphi)} d\phi = 2\pi(i^n) J_n(x) \cos n\varphi$$
$$\int_0^{2\pi} \sin n\phi e^{ix \cos(\phi-\varphi)} d\phi = 2\pi(i^n) J_n(x) \sin n\varphi$$

SOLUTION

(0,0) mode :

$$\mathbf{E}(\rho, \varphi, z) = \frac{ikf}{2} \sqrt{\frac{n_1}{n_2}} E_o e^{-ikf} \begin{bmatrix} I_{00} + I_{02} \cos 2\varphi \\ I_{02} \sin 2\varphi \\ -2iI_{01} \cos \varphi \end{bmatrix}$$

$$\mathbf{H}(\rho, \varphi, z) = \frac{ikf}{2Z_{\mu\epsilon}} \sqrt{\frac{n_1}{n_2}} E_o e^{-ikf} \begin{bmatrix} I_{02} \sin 2\varphi \\ I_{00} - I_{02} \cos 2\varphi \\ -2iI_{01} \sin \varphi \end{bmatrix}$$

$$f_w(\theta) = e^{-\frac{1}{f_o^2} \frac{\sin^2 \theta}{\sin^2 \theta_{max}}}$$

Fields given by
3 integrals :

$$I_{00} = \int_0^{\theta_{max}} f_w(\theta) (\cos \theta)^{1/2} \sin \theta (1 + \cos \theta) J_0(k\rho \sin \theta) e^{ikz \cos \theta} d\theta$$

$$I_{01} = \int_0^{\theta_{max}} f_w(\theta) (\cos \theta)^{1/2} \sin^2 \theta J_1(k\rho \sin \theta) e^{ikz \cos \theta} d\theta$$

$$I_{02} = \int_0^{\theta_{max}} f_w(\theta) (\cos \theta)^{1/2} \sin \theta (1 - \cos \theta) J_2(k\rho \sin \theta) e^{ikz \cos \theta} d\theta$$

FOCAL FIELDS

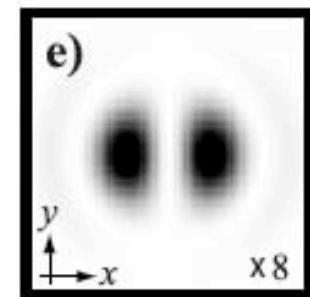
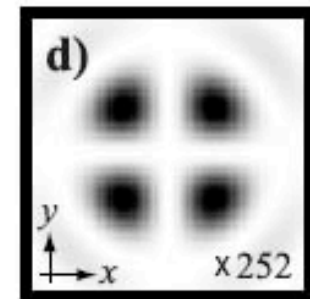
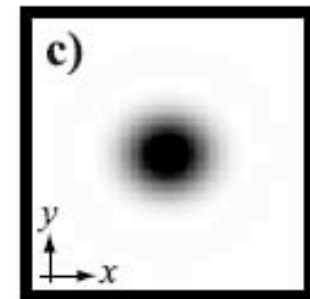
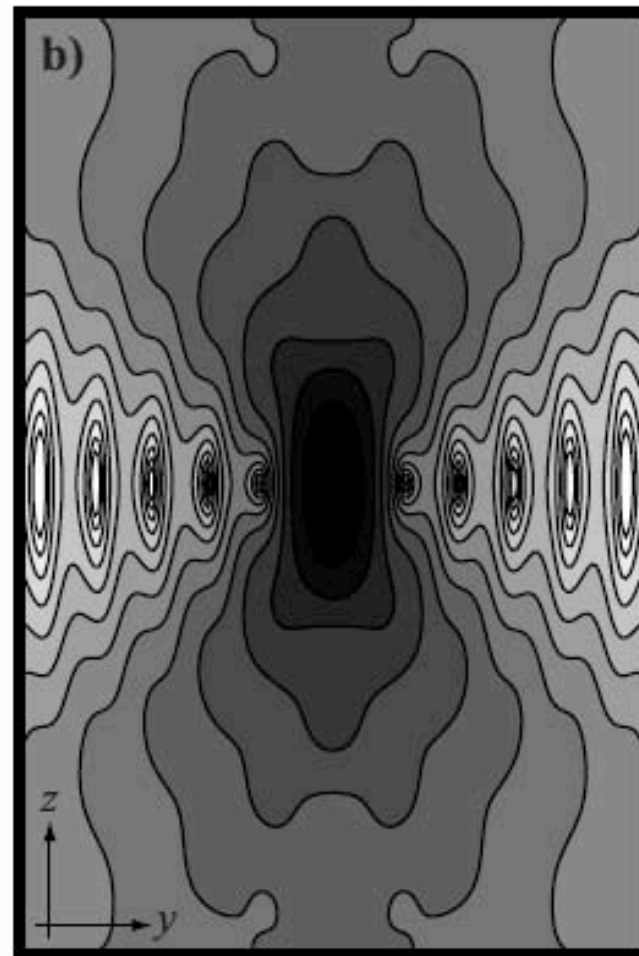
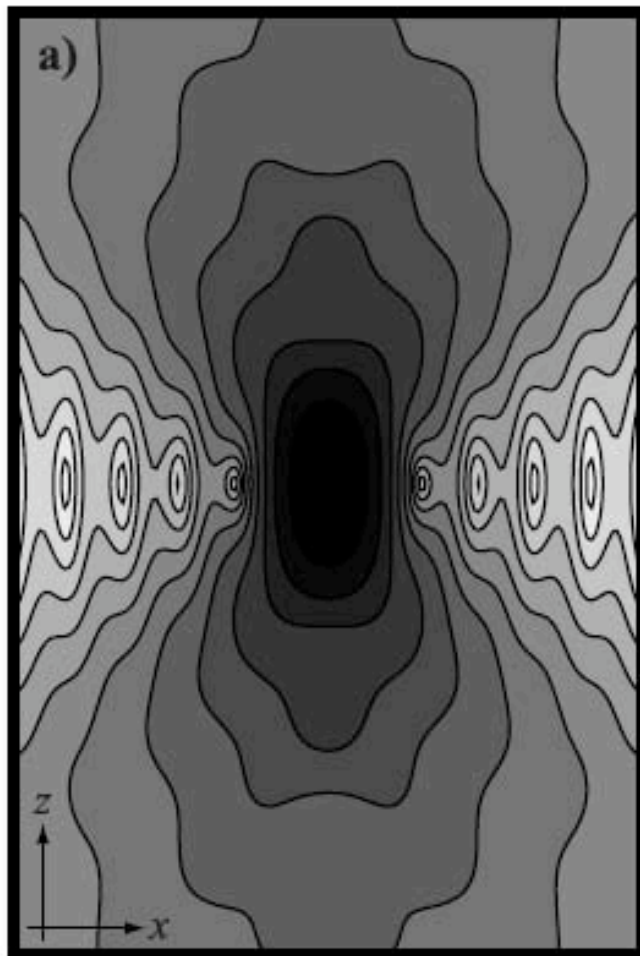

1.8λ

FOCAL FIELDS SAMPLED WITH SINGLE MOLECULES

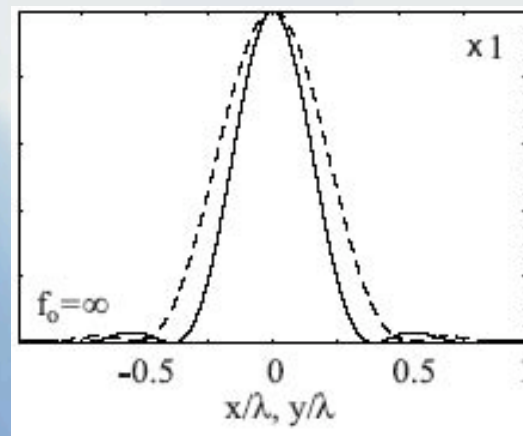
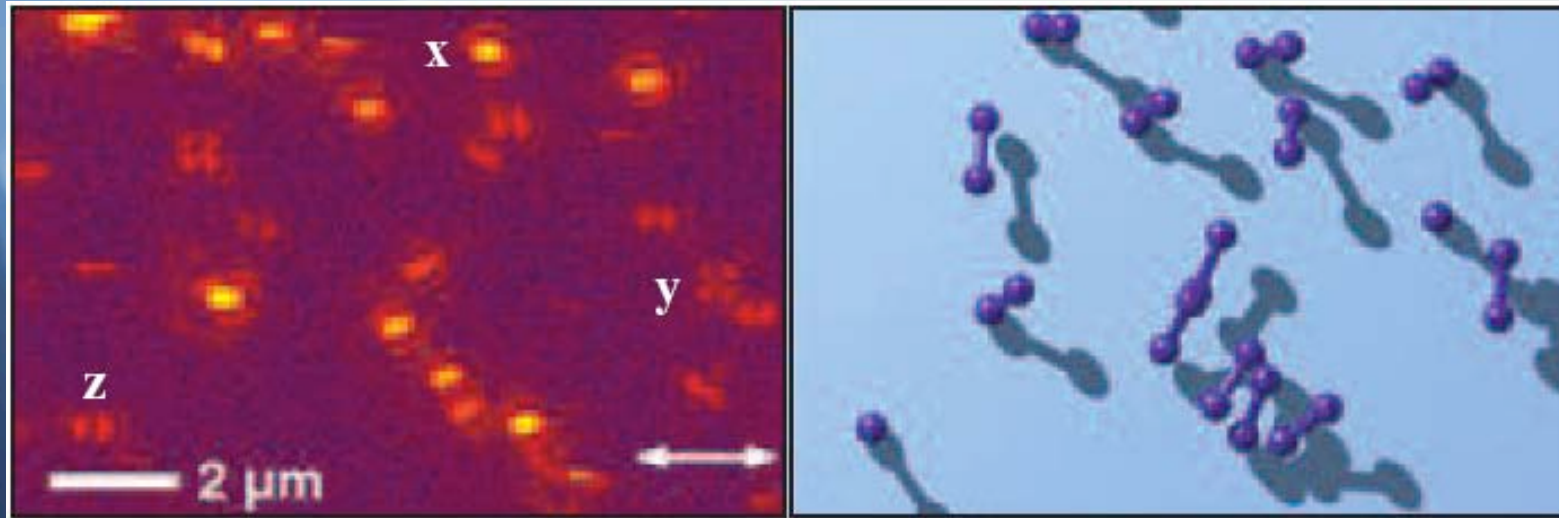

Elongated spot !!

λ -PHAGE DNA LABELED WITH YOYO-1

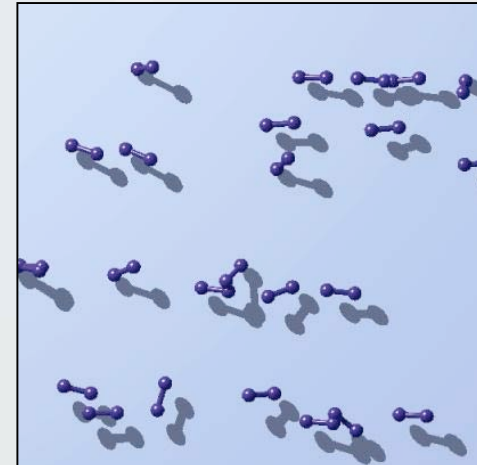
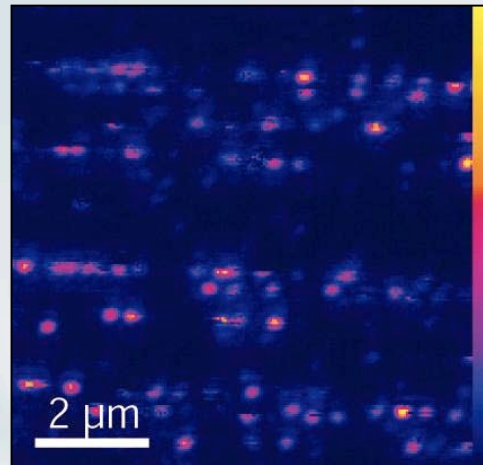
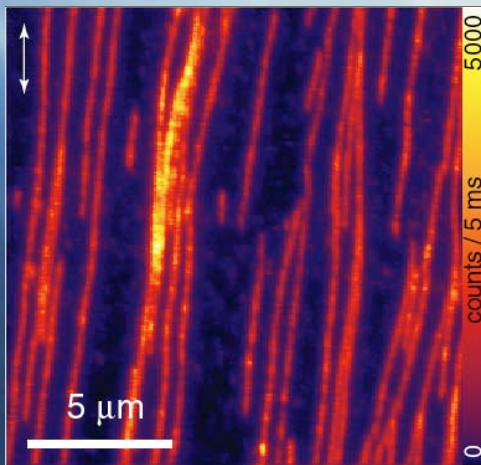

WEAKLY FOCUSED BEAMS

Focal plane ($z=0$):

$$I_{00} \approx \frac{2}{k\rho} \int_0^{k\rho\theta_{max}} x J_0(x) dx = 2\theta_{max}^2 \frac{J_1(k\rho\theta_{max})}{k\rho\theta_{max}}$$

$$E \approx ikf\theta_{max}^2 E_o e^{-ikf} \frac{J_1(k\rho\theta_{max})}{k\rho\theta_{max}} \mathbf{e}_x$$

Not Gaussian !

FOCUSED RADIALLY POLARIZED BEAMS

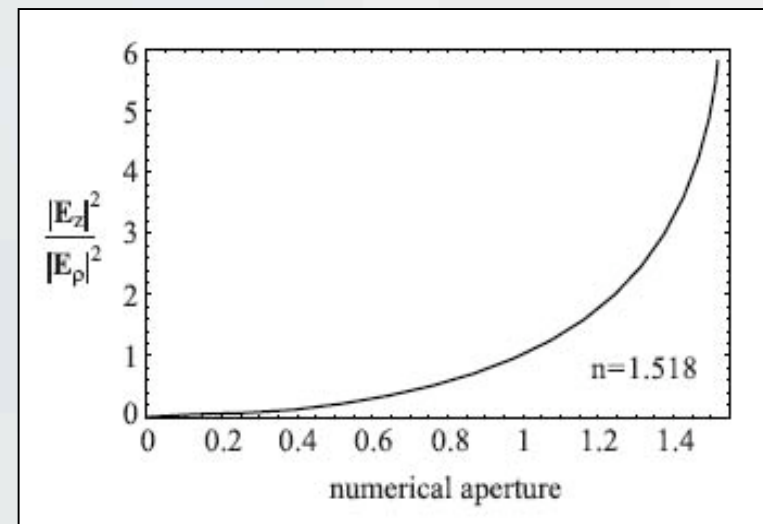
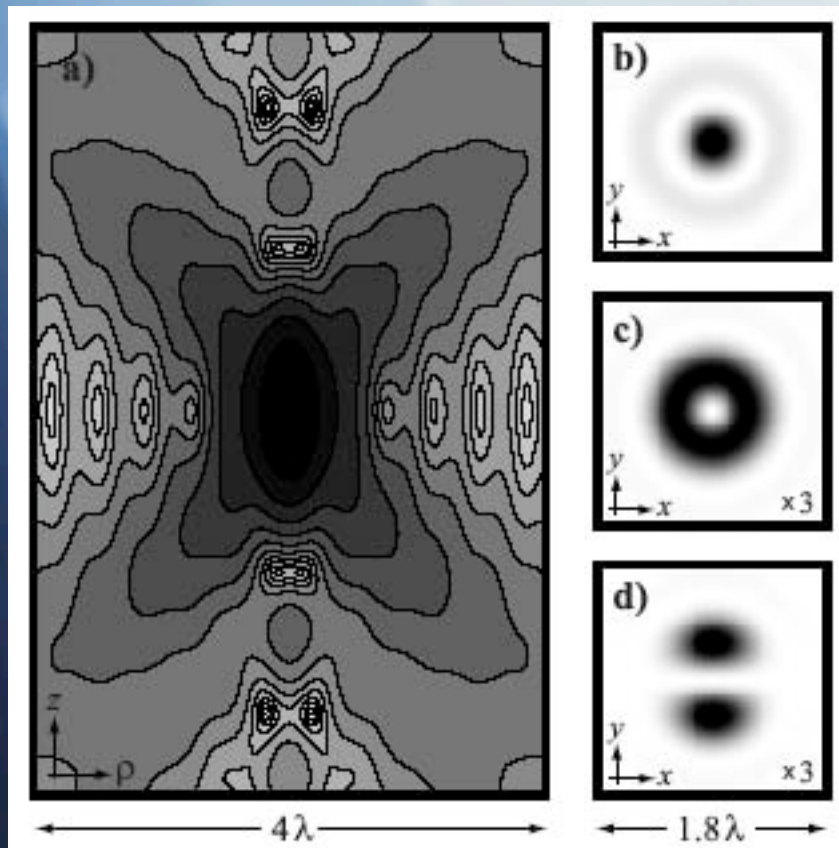

mostly longitudinal fields in focus !

FOCUSED RADIALLY POLARIZED BEAMS

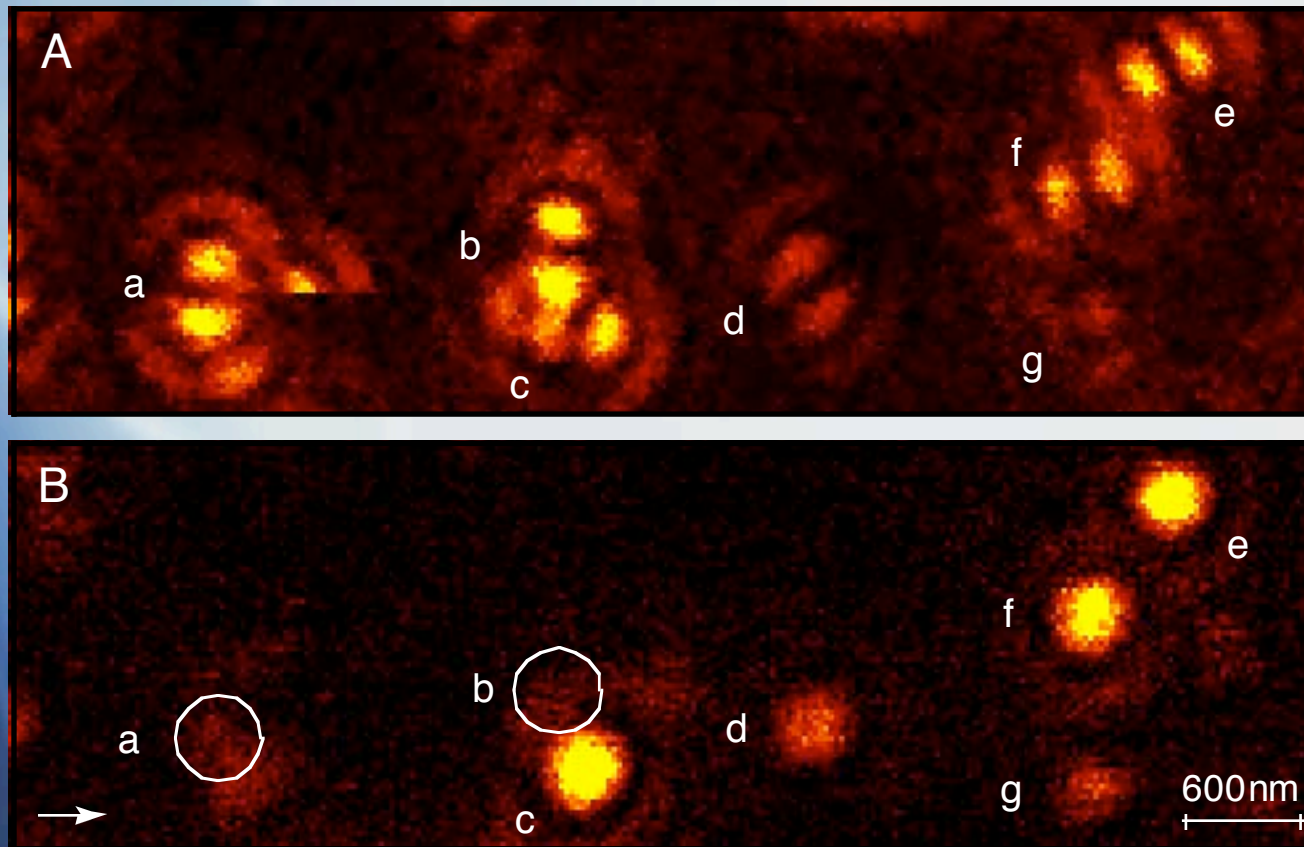

FOCUSED RADIALLY POLARIZED BEAMS

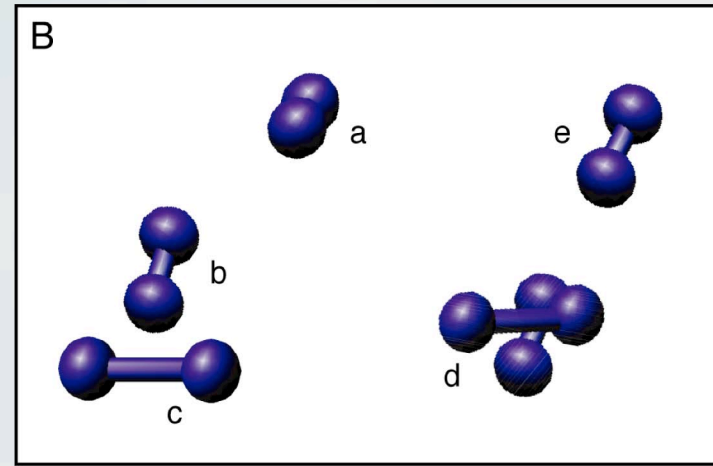
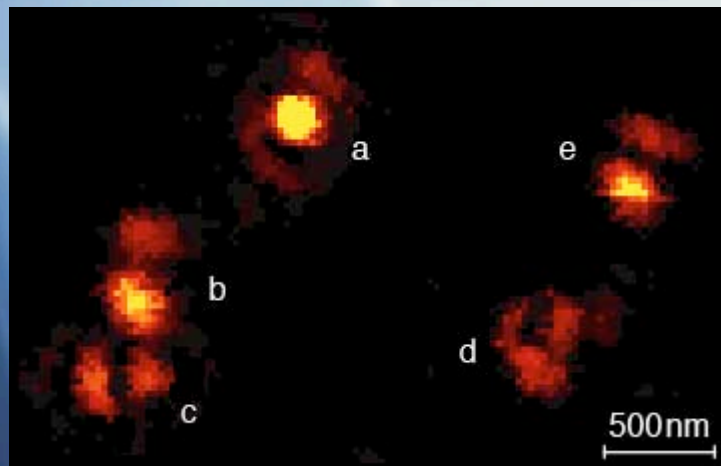

WHAT ABOUT INTERFACE ?

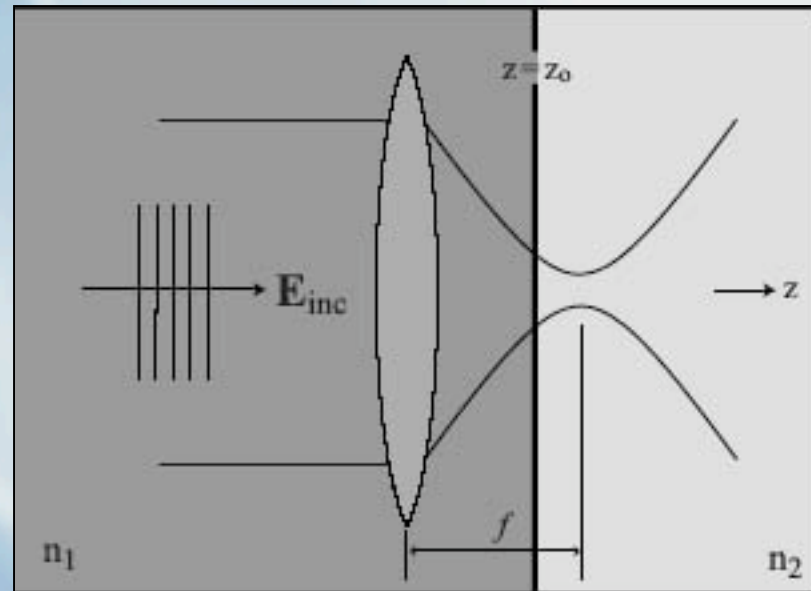

$$\mathbf{E} = \begin{cases} \mathbf{E}_f + \mathbf{E}_r & : z < z_0 \\ \mathbf{E}_t & : z > z_0 \end{cases}$$

Angular spectrum representation with Fresnel reflection / transmission coefficients.

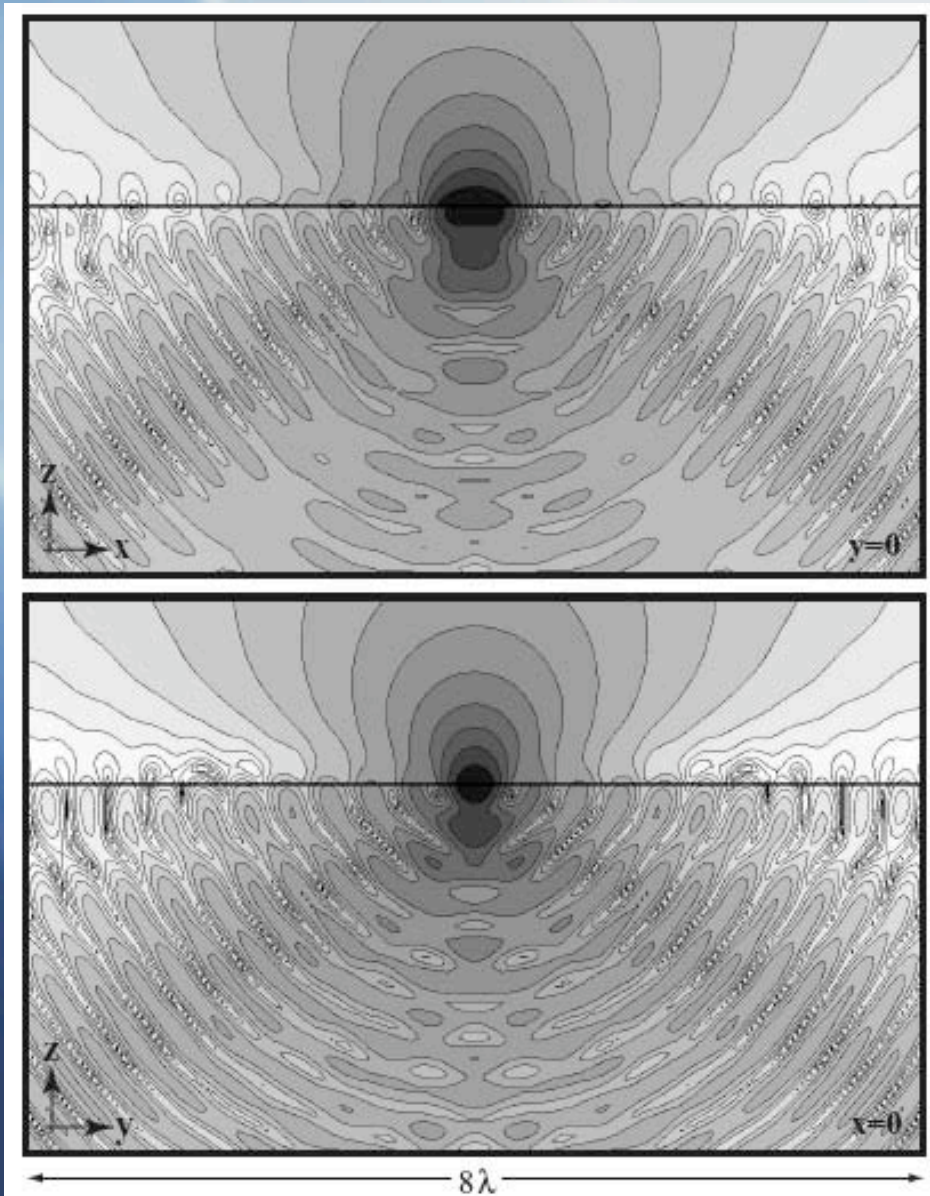

$$k_{z2} = k_2 \sqrt{1 - \frac{k_1^2}{k_2^2} \sin^2 \theta}$$

EXAMPLE: LASER TWEEZERS

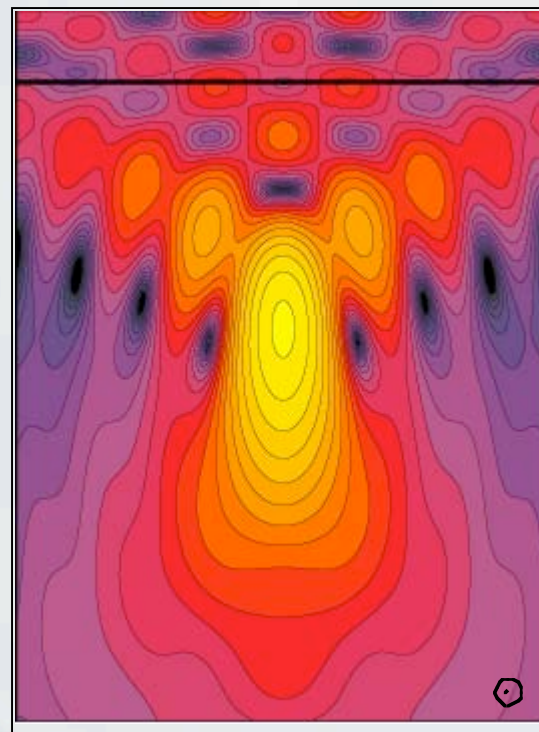
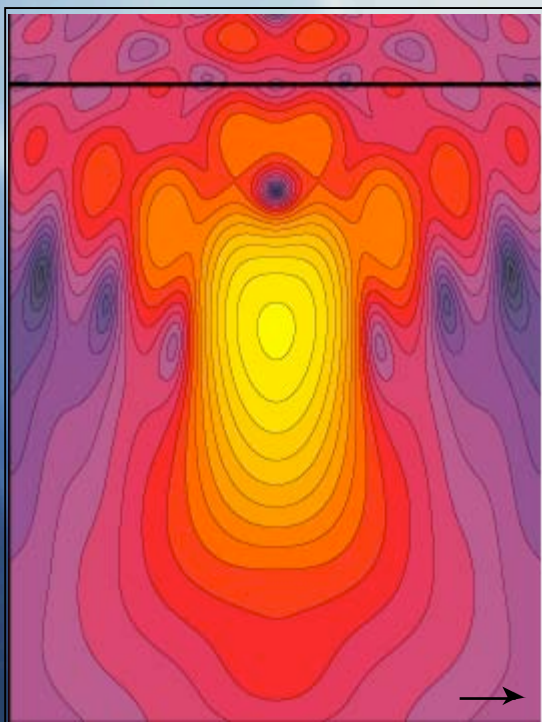

WHAT ABOUT EMISSION ?

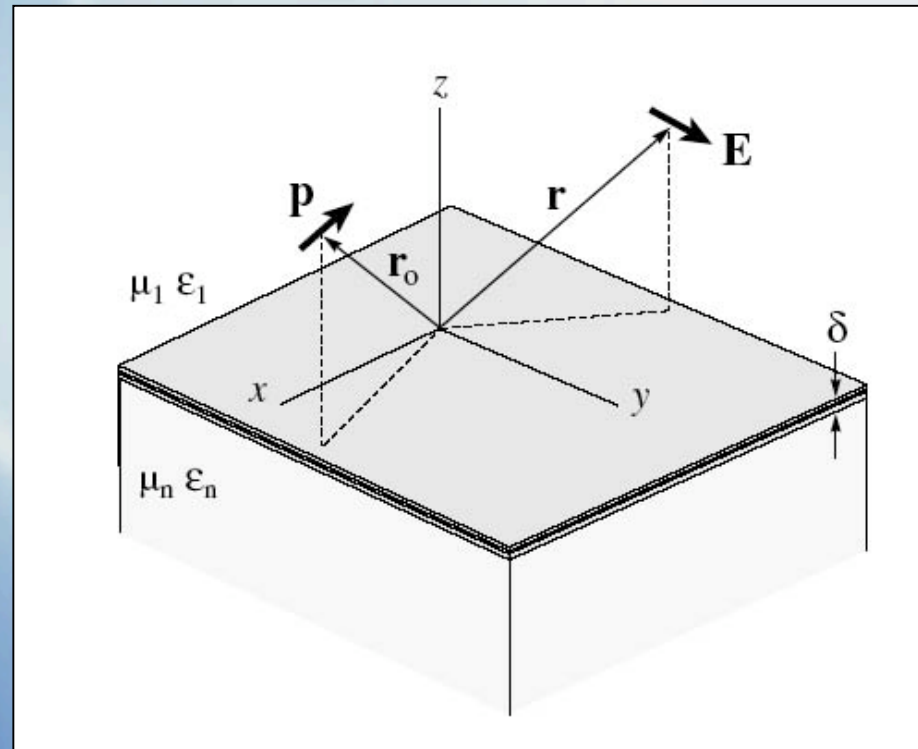

Molecules radiate like oscillating dipoles !!

COUPLING OF EVANESCENT WAVES

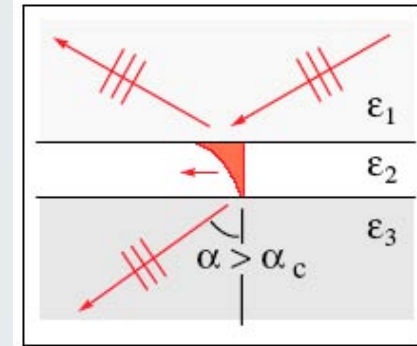
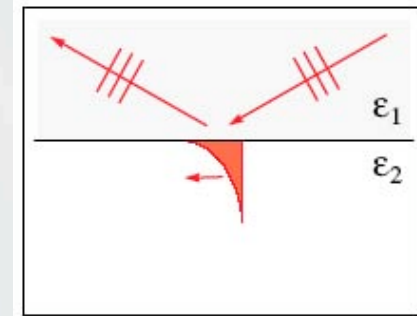
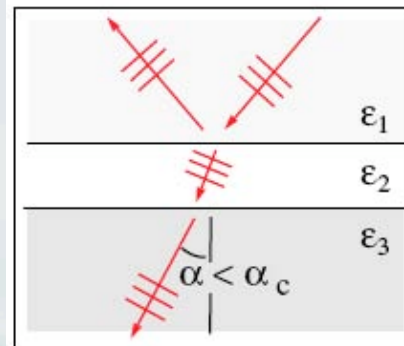
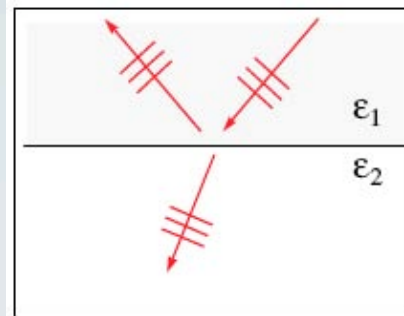
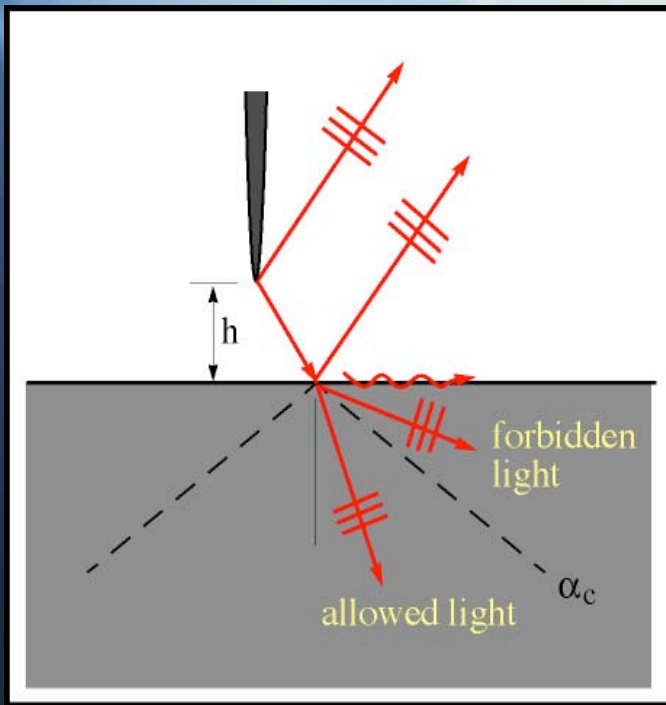

FARFIELD SOLUTION

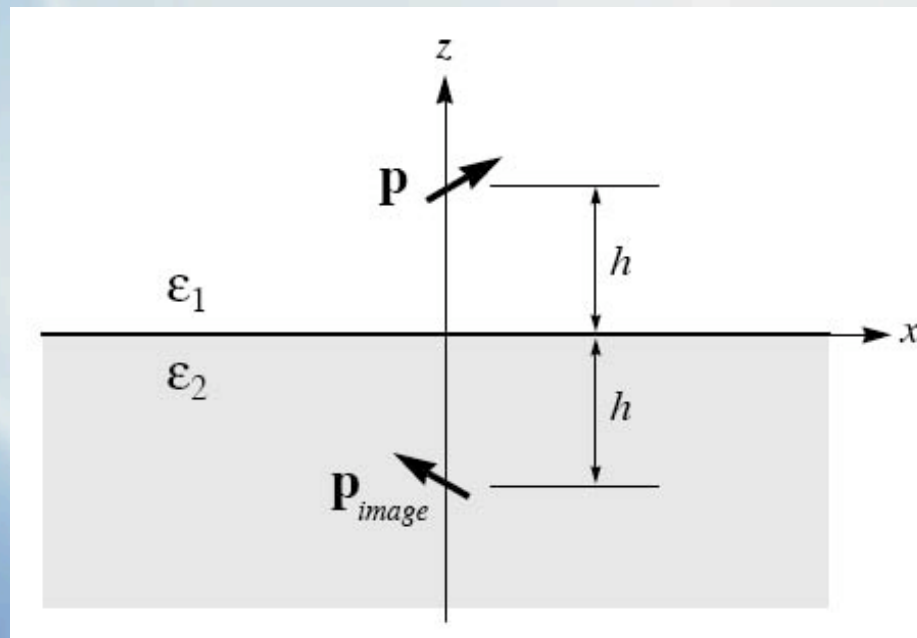

Exact solution = radiation from molecule and its image

RADIATION PATTERNS

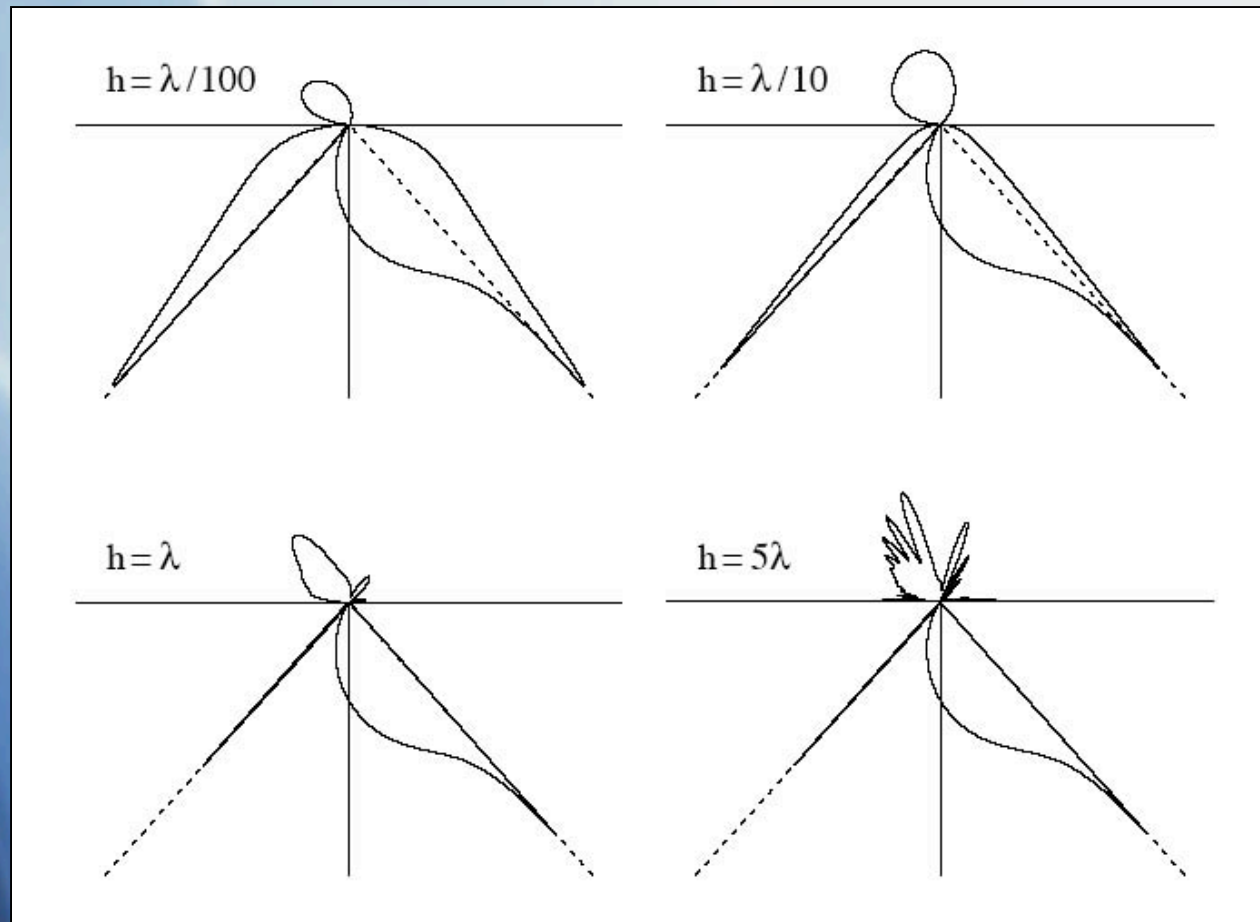

Need to sample the critical angle !!

DEMONSTRATION WITH SINGLE MOLECULES

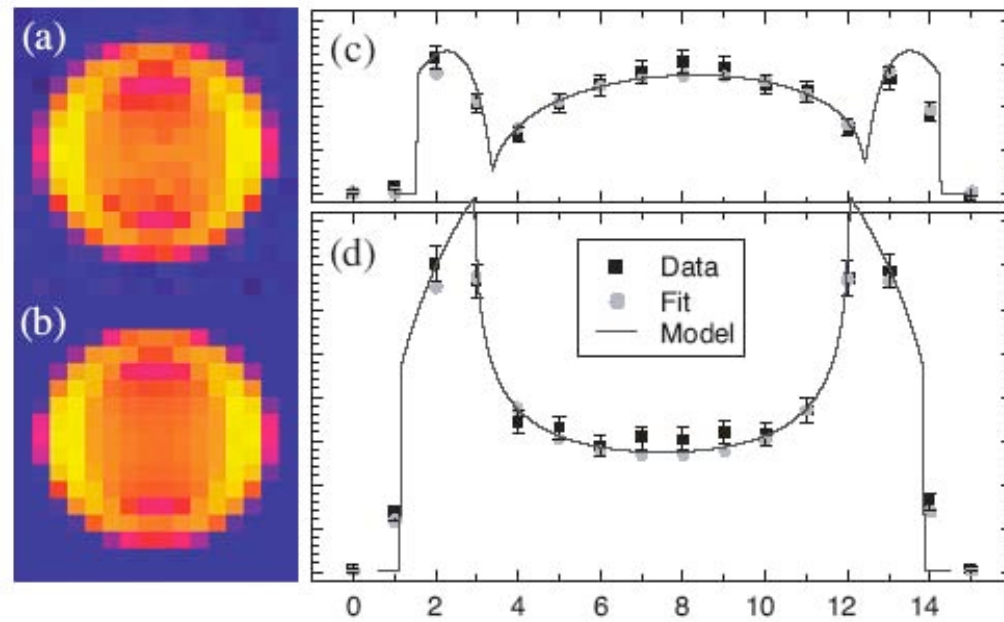
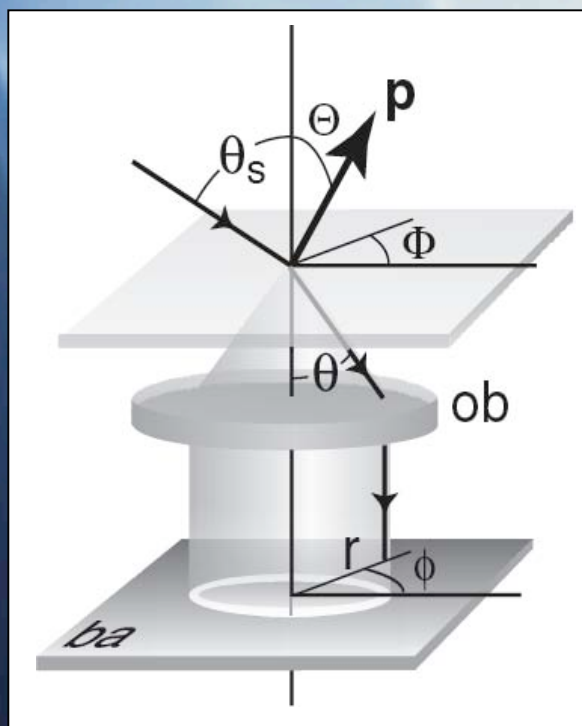

JOSA B 21, 1210 (2004)

SUMMARY

BIOPHYSICAL PROCESSES ARE VISUALIZED USING
SINGLE MOLECULES AS PROBES

EXCITATION OF SINGLE MOLECULES

- Angular Spectrum Representation
- Application to Strongly Focused Laser Beams
- Experimental Mapping using Single Molecules as Probe Dipoles

DETECTION OF SINGLE MOLECULES

- Molecule Radiates like Oscillating Dipole
- Interface Perturbs Radiation Pattern
- Collection Optics needs to include Critical Angle