



The Abdus Salam
International Centre for Theoretical Physics



SMR: 1643/8

*WINTER COLLEGE ON OPTICS ON OPTICS AND PHOTONICS
IN NANOSCIENCE AND NANOTECHNOLOGY*

(7 - 18 February 2005)

"Biophotonics at the Nanoscale" - II

presented by:

L. Novotny
The Institute of Optics
Rochester
U.S.A.

These are preliminary lecture notes, intended only for distribution to participants.

SP FRET

(single-pair fluorescence resonance energy transfer)

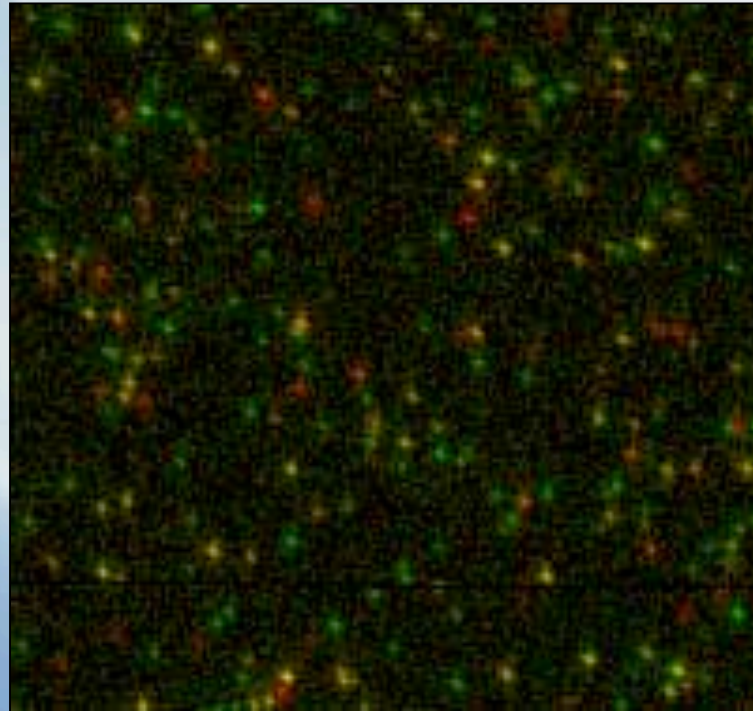

www.nano-optics.org

Lukas Novotny

The Institute of Optics, University of Rochester, Rochester, NY, 14627.

EXAMPLE: ROCKERSWITH MODEL FOR GlpT

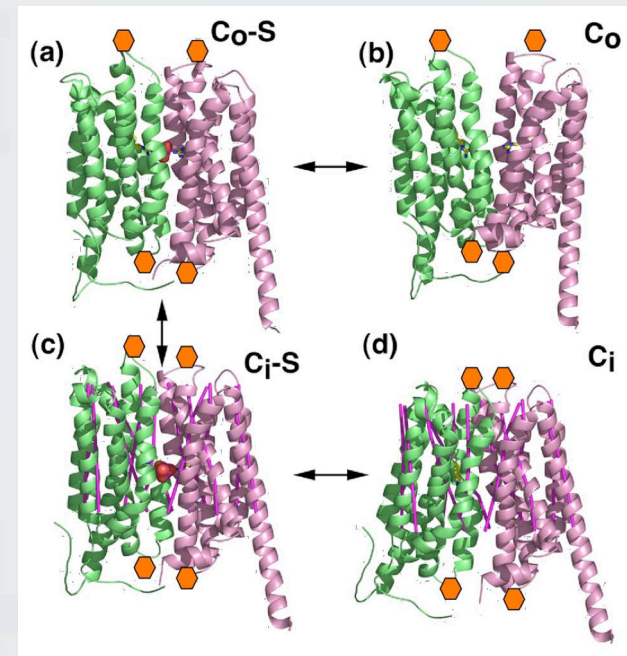
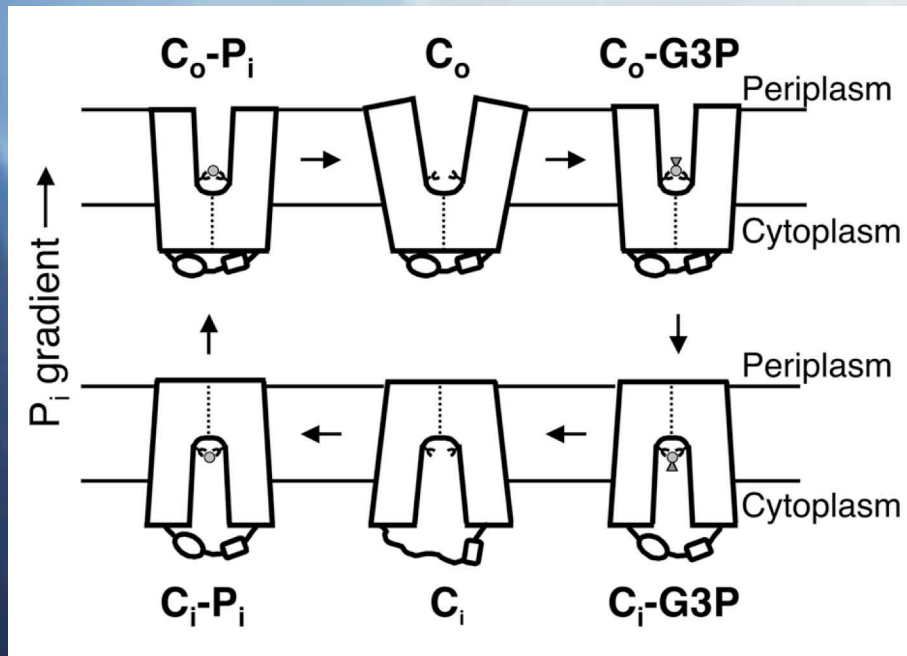

Reaction cycle of substrate translocation: Proposed single-binding-site, alternating-access mechanism with a rocker-switch type of movement . Positions of Arg45 and Arg269 are indicated. P_i is represented by a small disk, and the G3P molecule as a small disk and a triangle.

TEXTBOOK (Cambridge Univ. Press)

PRINCIPLES
OF
NANO-OPTICS

Lukas Novotny

The Institute of Optics
University of Rochester, Rochester, New York

Bert Hecht

Institute of Physics
University of Basel, Basel, Switzerland

CONFORMATIONAL STATES OF AE1

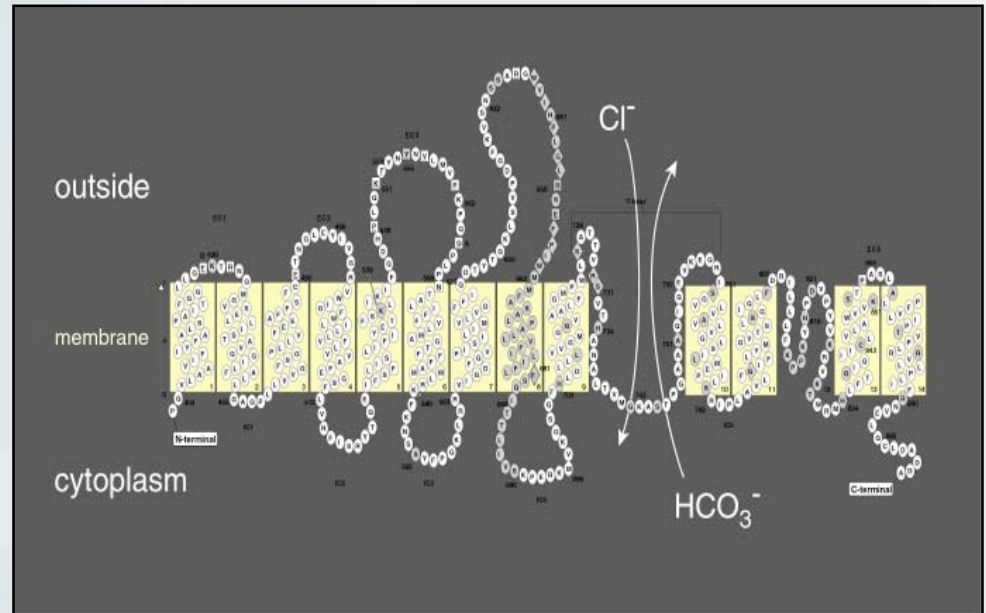
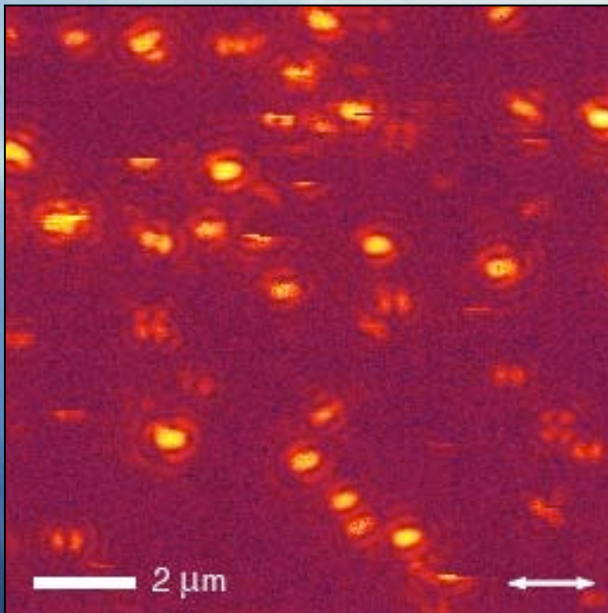

Collaboration with Prof. P. Knauf (Biochemistry, Rochester)

FOERSTER ENERGY TRANSFER

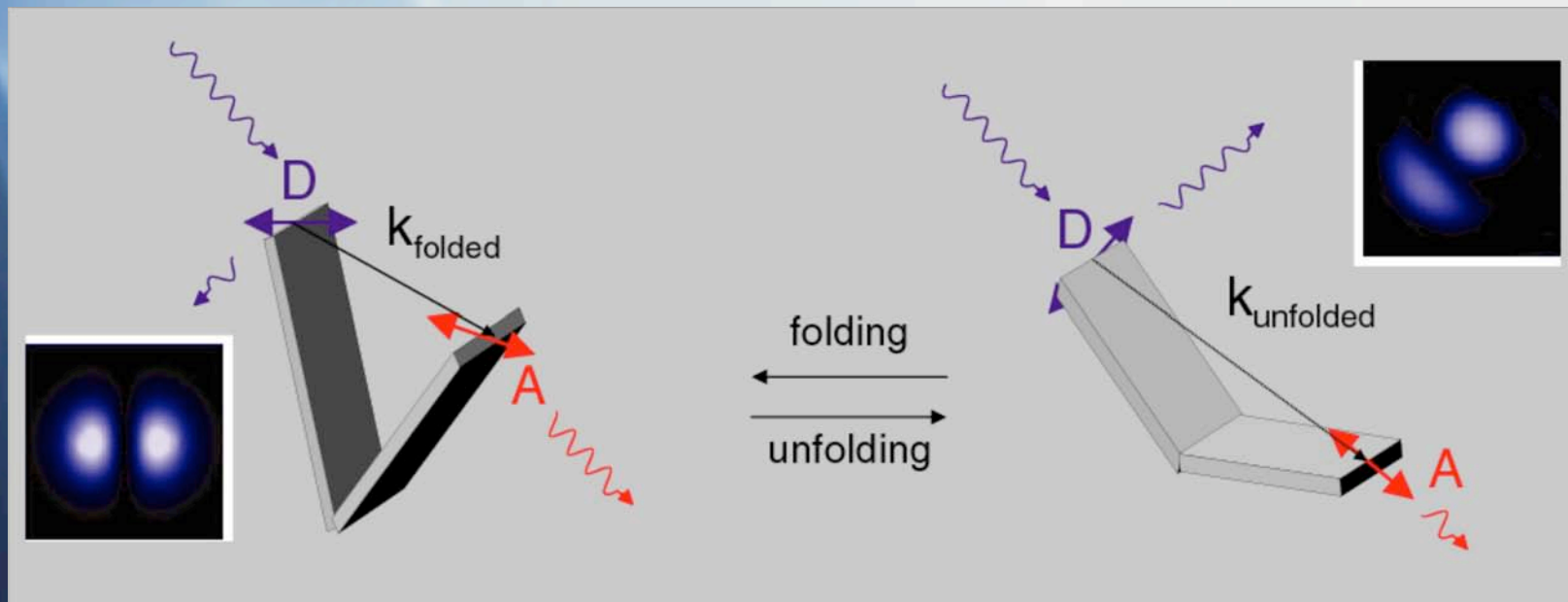

$$R_o^6 = \frac{9000(\ln 10) \kappa^2 \phi_D}{128\pi^2 N_{av} n^4} \int_0^\infty F_D(\lambda) \epsilon_A(\lambda) \lambda^4 d\lambda$$

$$\kappa^2 = [\mathbf{n}_A \cdot \mathbf{n}_D - 3(\mathbf{n}_R \cdot \mathbf{n}_D)(\mathbf{n}_R \cdot \mathbf{n}_A)]^2$$

FOERSTER WHO ?



Robert S. Knox (left) and Theodore Foerster (right) preparing for mechanical energy transfer. Springwater, NY, August 1973.

CYTOPLASMIC DOMAIN OF AE1 (CDB3)

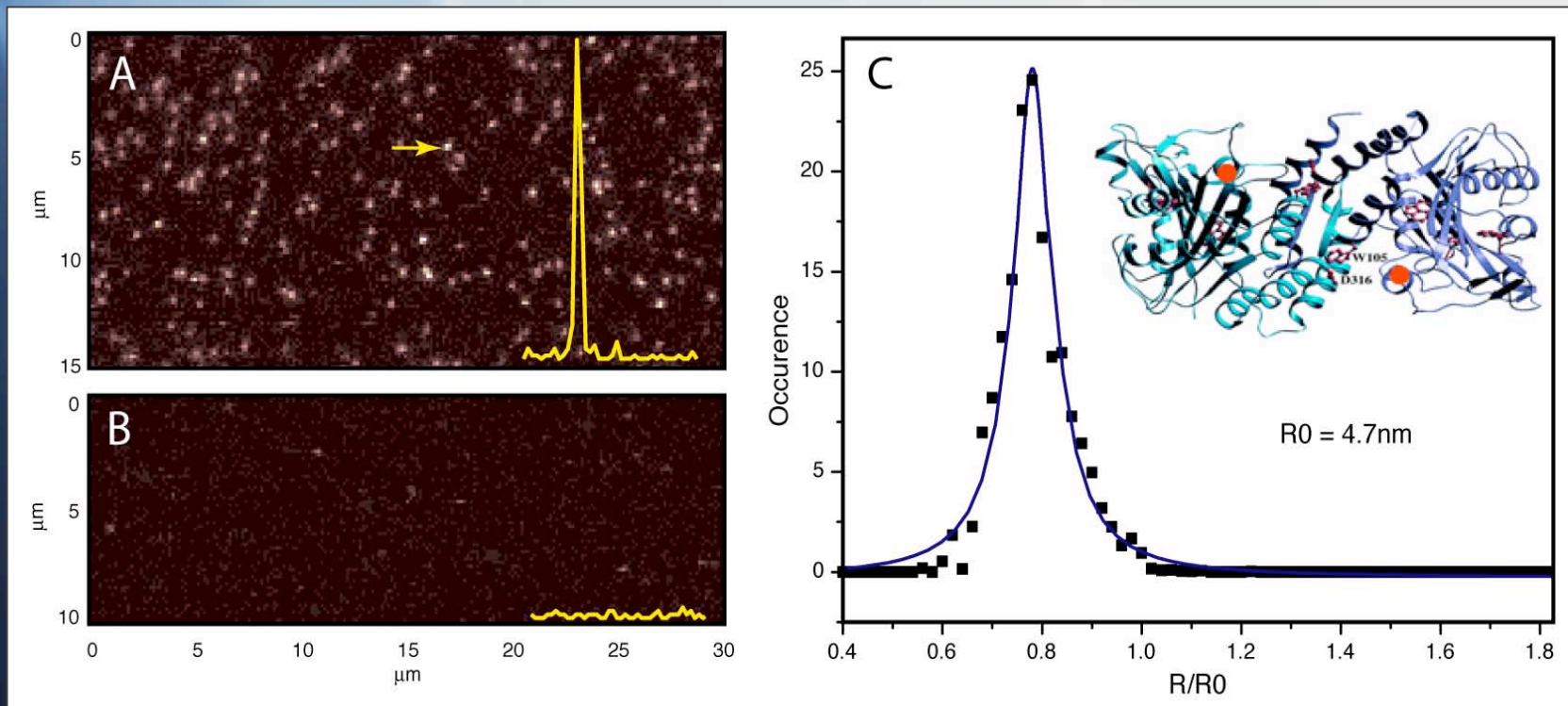

STATIC CONFORMATIONS OF AE1

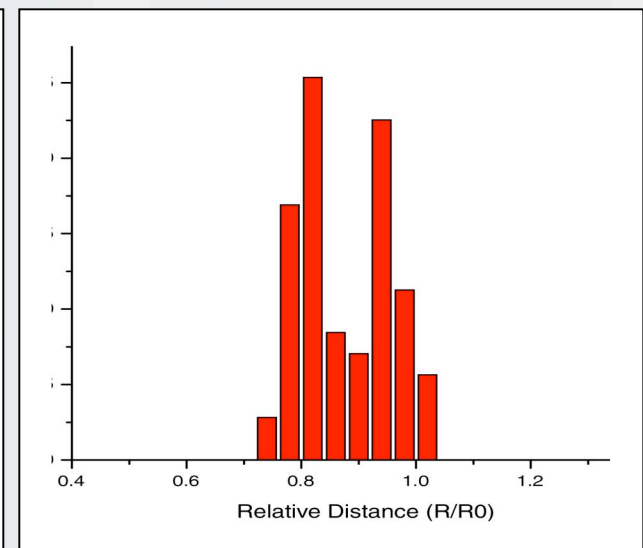
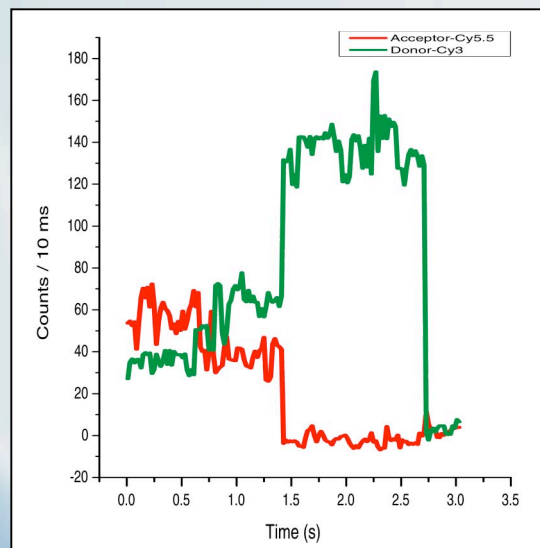
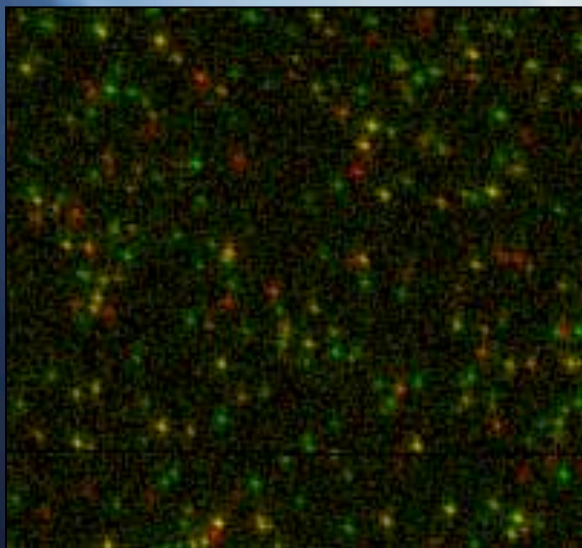

STATIC CONFORMATIONS OF AE1

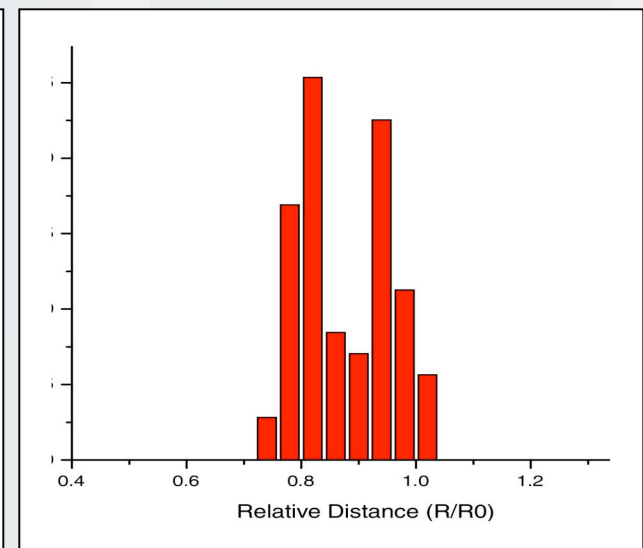
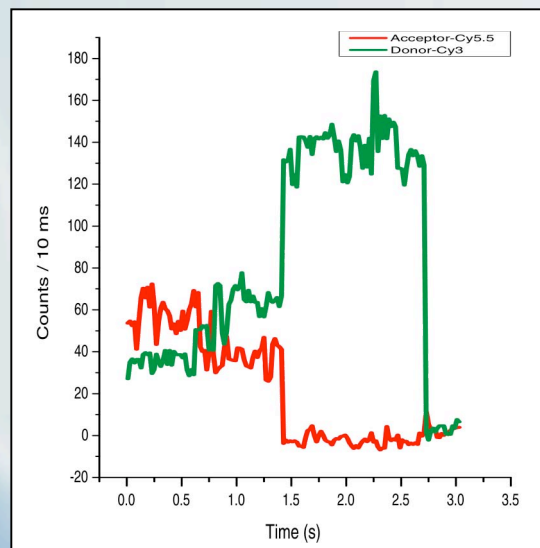
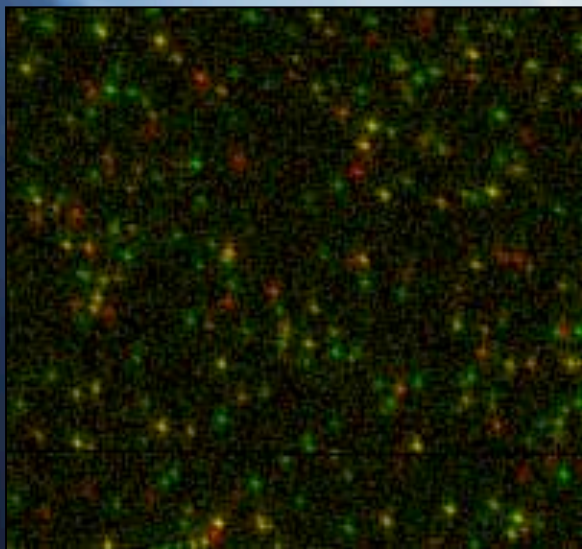

PROBLEM: PURIFICATION

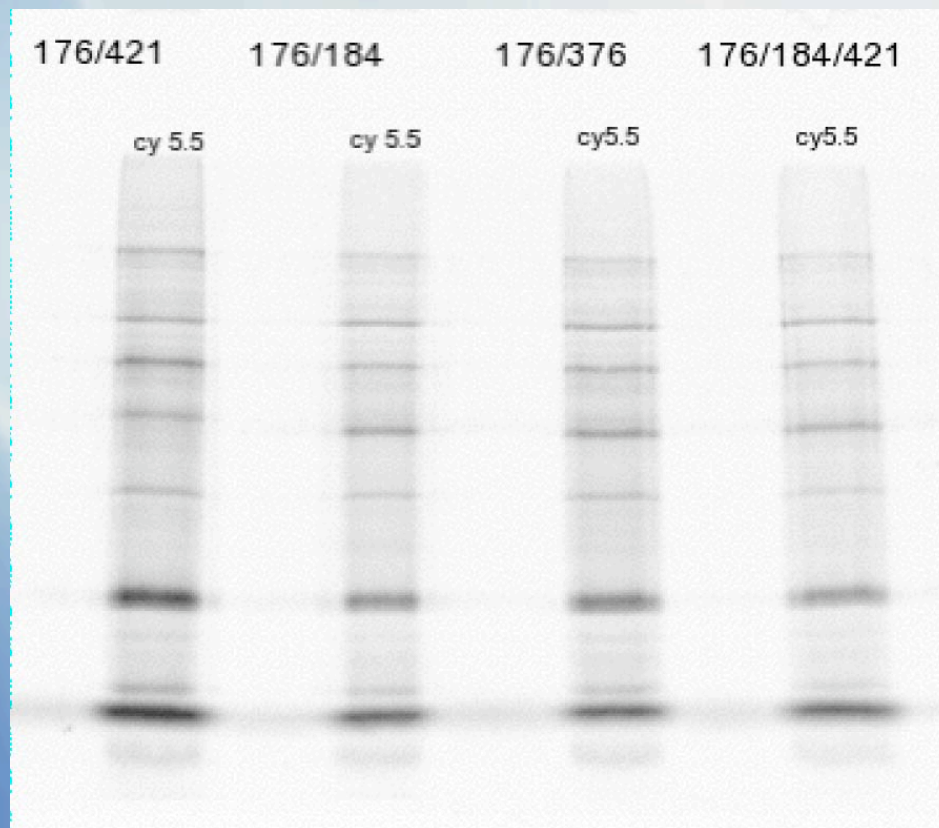

ENERGY TRANSFER THEORY

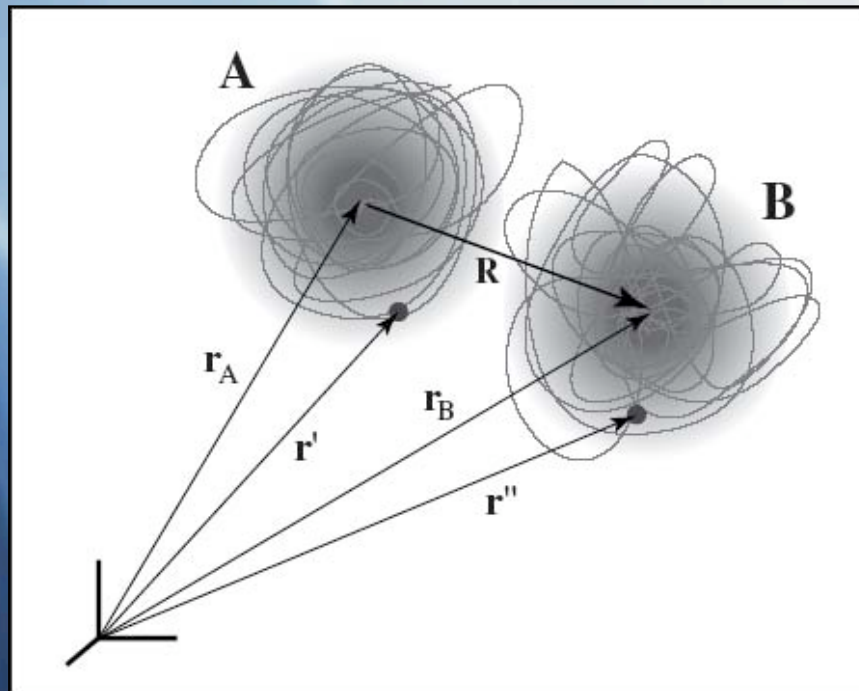

$$q_A = \int \rho_A(\mathbf{r}') dV'$$

$$\mu_A = \int \rho_A(\mathbf{r}') (\mathbf{r}' - \mathbf{r}_A) dV'$$

$$V_{AB}(\mathbf{R}) = \frac{1}{4\pi\epsilon_0} \left[\frac{q_A q_B}{R} + \frac{q_A \mu_B \cdot \mathbf{R}}{R^3} - \frac{q_B \mu_A \cdot \mathbf{R}}{R^3} + \frac{R^2 \mu_A \cdot \mu_B - 3(\mu_A \cdot \mathbf{R})(\mu_B \cdot \mathbf{R})}{R^5} + \dots \right]$$

LIMIT: WEAK COUPLING

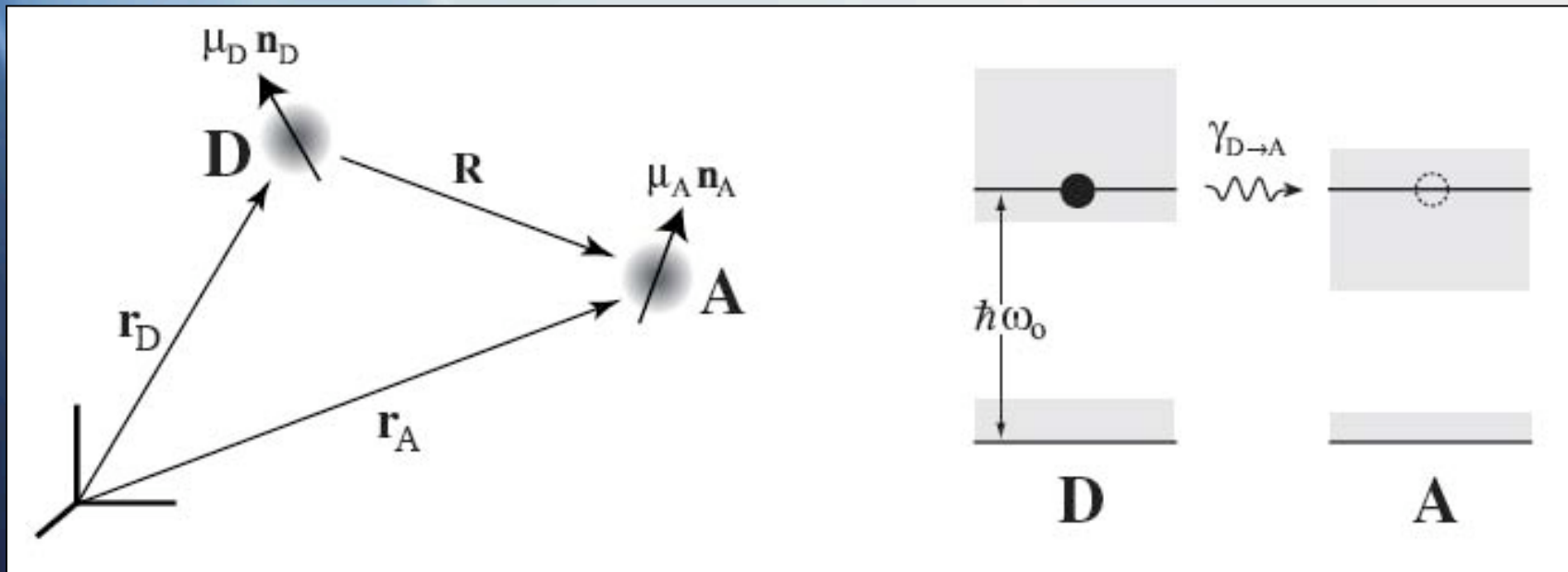

$$\frac{\gamma_{D \rightarrow A}}{\gamma_0} = \frac{P_{D \rightarrow A}}{P_0}$$

$$P_0 = \frac{|\mu_D|^2 n(\omega_0)}{12\pi \epsilon_0 c^3} \omega_0^4$$

GREEN'S FUNCTIONS

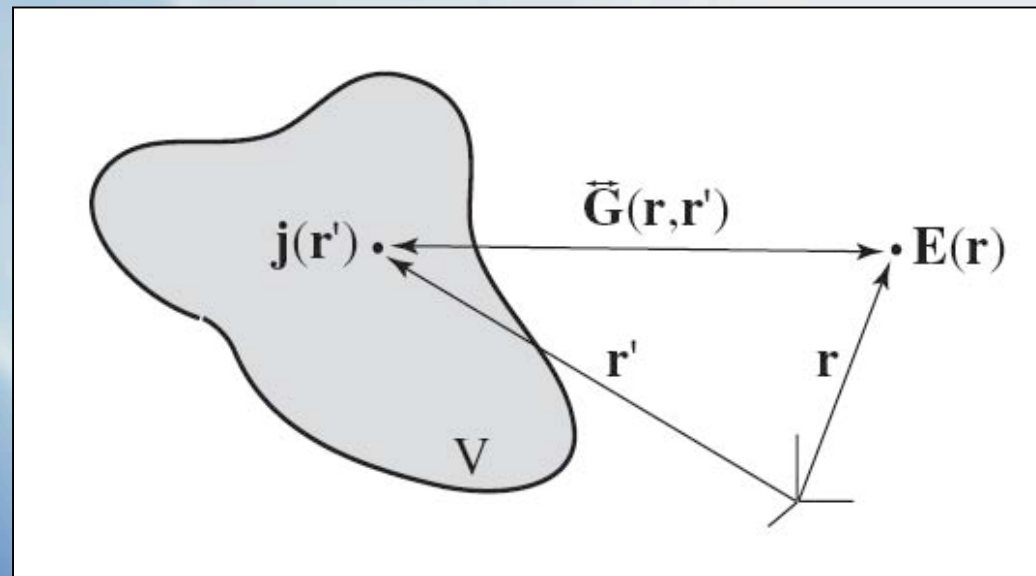

$$\mathbf{j}(\mathbf{r}) = -i\omega\mu\delta[\mathbf{r} - \mathbf{r}_o]$$

$$\mathbf{E}(\mathbf{r}) = \omega^2\mu_o\mu\vec{\mathbf{G}}(\mathbf{r}, \mathbf{r}')\mu$$

POWER TRANSFER

$$P_{D \rightarrow A} = -\frac{1}{2} \int_{V_A} \text{Re}\{\mathbf{j}_A^* \cdot \mathbf{E}_D\} dV$$

For $\mathbf{j}_A = -i\omega_o \mu_A \delta(\mathbf{r} - \mathbf{r}_A)$:

$$P_{D \rightarrow A} = \frac{\omega_o}{2} \text{Im}\{\mu_A^* \cdot \mathbf{E}_D(\mathbf{r}_A)\}$$

Induced dipole $\mu_A = \vec{\alpha}_A \mathbf{E}_D(\mathbf{r}_A)$ with $\vec{\alpha}_A = \alpha_A \mathbf{n}_A \mathbf{n}_A$:

$$P_{D \rightarrow A} = \frac{\omega_o}{2} \text{Im}\{\alpha_A\} |\mathbf{n}_A \cdot \mathbf{E}_D(\mathbf{r}_A)|^2$$

ABSORPTION CROSS-SECTION

$$\sigma(\omega_o) = \frac{\langle P(\omega_o) \rangle}{I(\omega_o)}$$

$$\sigma(\omega_o) = \frac{(\omega_o/2) \operatorname{Im}\{\alpha(\omega_o)\} \langle |\mathbf{n}_p \cdot \mathbf{E}_D|^2 \rangle}{(1/2) (\epsilon_o/\mu_o)^{1/2} n(\omega_o) |\mathbf{E}_D|^2} = \frac{\omega_o}{3} \sqrt{\frac{\mu_o}{\epsilon_o}} \frac{\operatorname{Im}\{\alpha(\omega_o)\}}{n(\omega_o)}$$

$$P_{D \rightarrow A} = \frac{3}{2} \sqrt{\frac{\epsilon_o}{\mu_o}} n(\omega_o) \sigma_A(\omega_o) |\mathbf{n}_A \cdot \mathbf{E}_D(\mathbf{r}_A)|^2$$

FIELD OF DONOR EVALUATED AT ACCEPTOR

$$\mathbf{E}_D(\mathbf{r}_A) = \omega_o^2 \mu_o \vec{\mathbf{G}}(\mathbf{r}_D, \mathbf{r}_A) \mu_D$$

Short-hand:

$$T(\omega_o) = 16\pi^2 k^4 R^6 \left| \mathbf{n}_A \cdot \vec{\mathbf{G}}(\mathbf{r}_D, \mathbf{r}_A) \mathbf{n}_D \right|^2$$

where $R = |\mathbf{r}_D - \mathbf{r}_A|$

$$k = (\omega_o/c) n(\omega_o).$$

$$\frac{\gamma_{D \rightarrow A}}{\gamma_o} = \frac{9c^4}{8\pi R^6} \frac{\sigma_A(\omega_o)}{n^4(\omega_o) \omega_o^4} T(\omega_o) = \frac{9c^4}{8\pi R^6} \int_0^\infty \frac{\delta(\omega - \omega_o) \sigma_A(\omega)}{n^4(\omega) \omega^4} T(\omega) d\omega$$

INCLUDE EMISSION SPECTRUM

$$\int_0^{\infty} \delta(\omega - \omega_0) d\omega = 1 \quad \longrightarrow \quad \int_0^{\infty} f_D(\omega) d\omega = 1$$

$$\frac{\gamma_{D \rightarrow A}}{\gamma_0} = \frac{9c^4}{8\pi R^6} \int_0^{\infty} \frac{f_D(\omega) \sigma_A(\omega)}{n^4(\omega) \omega^4} T(\omega) d\omega$$

Evaluate $T(\omega)$:

$$\begin{aligned} T(\omega) = & (1 - k^2 R^2 + k^4 R^4) (\mathbf{n}_A \cdot \mathbf{n}_D)^2 + \\ & (9 + 3k^2 R^2 + k^4 R^4) (\mathbf{n}_R \cdot \mathbf{n}_D)^2 (\mathbf{n}_R \cdot \mathbf{n}_A)^2 + \\ & (-6 + 2k^2 R^2 - 2k^4 R^4) (\mathbf{n}_A \cdot \mathbf{n}_D) (\mathbf{n}_R \cdot \mathbf{n}_D) (\mathbf{n}_R \cdot \mathbf{n}_A) \end{aligned}$$

$$\langle T(\omega) \rangle = \frac{2}{3} + \frac{2}{9} k^2 R^2 + \frac{2}{9} k^4 R^4$$

ONLY NEAR-FIELD TERMS

$$\frac{\gamma_{D \rightarrow A}}{\gamma_o} = \left[\frac{R_o}{R} \right]^6, \quad R_o^6 = \frac{9c^4 \kappa^2}{8\pi} \int_0^\infty \frac{f_D(\omega) \sigma_A(\omega)}{n^4(\omega) \omega^4} d\omega$$

$$\kappa^2 = [\mathbf{n}_A \cdot \mathbf{n}_D - 3(\mathbf{n}_R \cdot \mathbf{n}_D)(\mathbf{n}_R \cdot \mathbf{n}_A)]^2$$

EXAMPLE: Alexa Fluor 532 (A) and Fluorescein (D)

Fitting :

$$\sum_{n=1}^N A_n e^{-(\lambda - \lambda_n)^2 / \Delta \lambda_n^2}$$

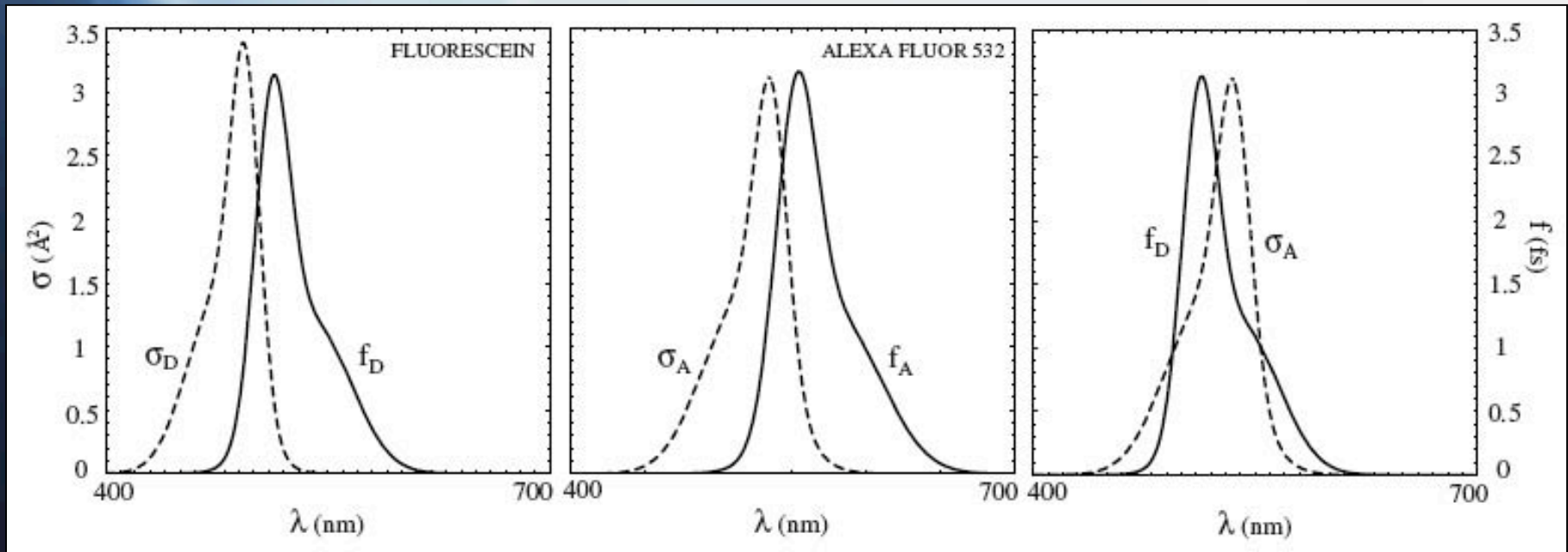

Water: $R_o = 6.3\text{nm}$; Air: $R_o = 7.6\text{nm}$

DONOR / ACCEPTOR FLUORESCENCE

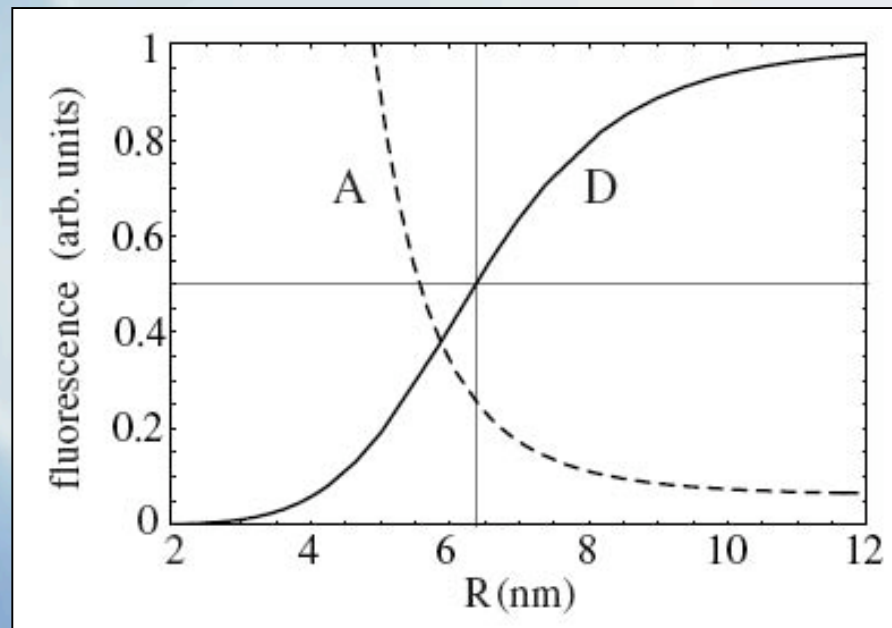

$$E = \frac{P_o}{P_o + P_{D \rightarrow A}} = \frac{1}{1 + (\gamma_o / \gamma_{D \rightarrow A})} = \frac{1}{1 + (R/R_o)^6}$$

EXAMPLE: DNA HOLIDAY JUNCTION

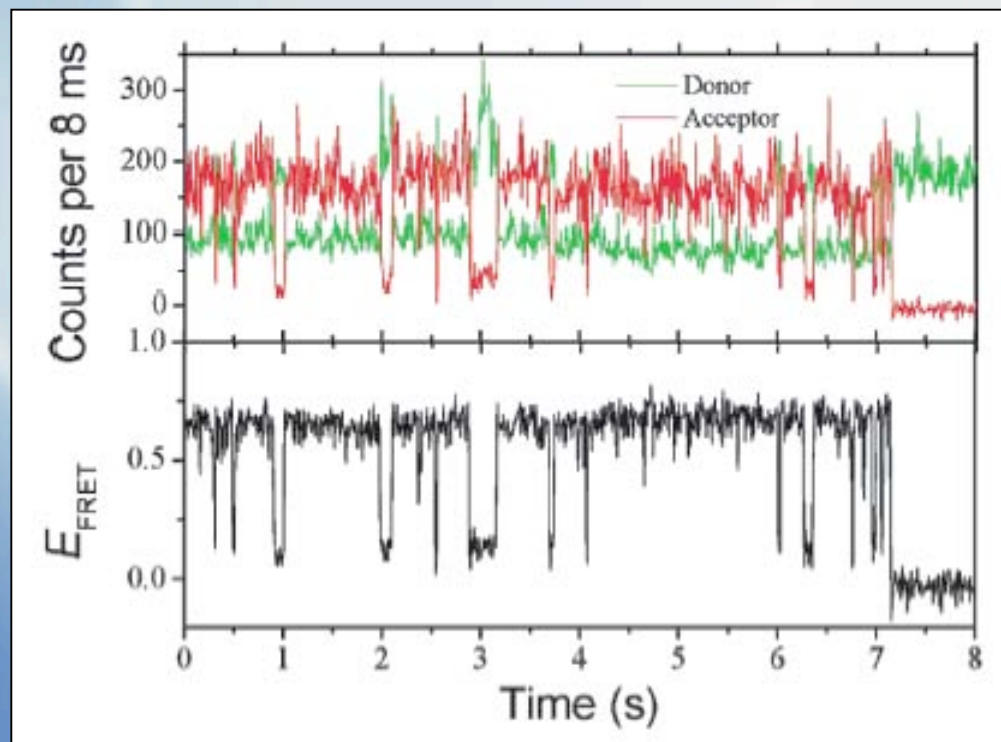

Taekjip Ha (Urbana-Champaign)

STRONG COUPLING REGIME

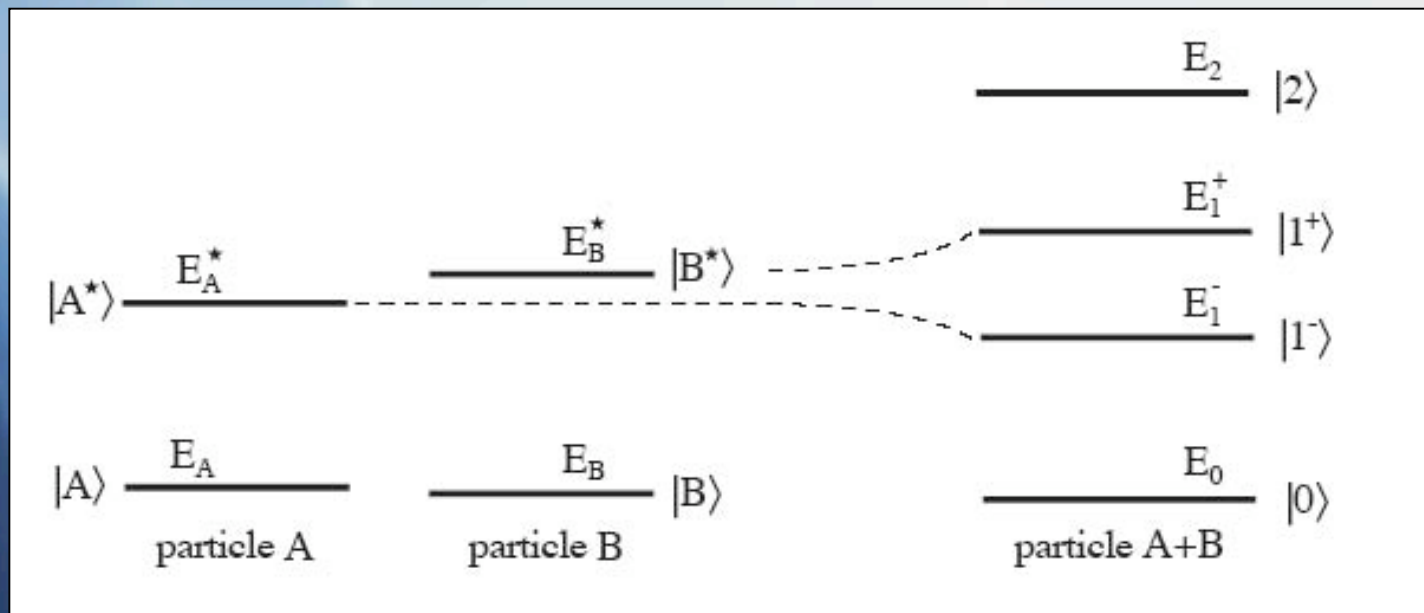

$$|1^+\rangle = \cos \alpha |A^*B\rangle + \sin \alpha |AB^*\rangle$$

$$|1^-\rangle = \sin \alpha |A^*B\rangle - \cos \alpha |AB^*\rangle$$

SUMMARY

FRET IS A POWERFUL TECHNIQUE TO MEASURE NANOSCALE DISTANCES

EFFECT CAN BE UNDERSTOOD BASED ON ANTENNA THEORY

- Gives correct Result for Near-field, Intermediate Field, and Farfield
- Strong Coupling Regime requires QM

